

Java Coding Problems

Improve your Java Programming skills by solving real-world coding challenges



Packt

www.packt.com

Anghel Leonard

Java Coding Problems

Improve your Java Programming skills by solving real-world coding challenges

Anghel Leonard

Packt

BIRMINGHAM - MUMBAI

Java Coding Problems

Copyright © 2019 Packt Publishing

All rights reserved. No part of this book may be reproduced, stored in a retrieval system, or transmitted in any form or by any means, without the prior written permission of the publisher, except in the case of brief quotations embedded in critical articles or reviews.

Every effort has been made in the preparation of this book to ensure the accuracy of the information presented. However, the information contained in this book is sold without warranty, either express or implied. Neither the author, nor Packt Publishing or its dealers and distributors, will be held liable for any damages caused or alleged to have been caused directly or indirectly by this book.

Packt Publishing has endeavored to provide trademark information about all of the companies and products mentioned in this book by the appropriate use of capitals. However, Packt Publishing cannot guarantee the accuracy of this information.

Commissioning Editor: Richa Tripathi
Acquisition Editor: Alok Dhuri
Content Development Editor: Zeeyan Pinheiro
Senior Editor: Afshaan Khan
Technical Editor: Pradeep Sahu
Copy Editor: Safis Editing
Project Coordinator: Prajakta Naik
Proofreader: Safis Editing
Indexer: Manju Arasan
Production Designer: Aparna Bhagat

First published: September 2019

Production reference: 1200919

Published by Packt Publishing Ltd.
Livery Place
35 Livery Street
Birmingham
B3 2PB, UK.

ISBN 978-1-78980-141-5

www.packt.com



Packt.com

Subscribe to our online digital library for full access to over 7,000 books and videos, as well as industry leading tools to help you plan your personal development and advance your career. For more information, please visit our website.

Why subscribe?

- Spend less time learning and more time coding with practical eBooks and Videos from over 4,000 industry professionals
- Improve your learning with Skill Plans built especially for you
- Get a free eBook or video every month
- Fully searchable for easy access to vital information
- Copy and paste, print, and bookmark content

Did you know that Packt offers eBook versions of every book published, with PDF and ePub files available? You can upgrade to the eBook version at www.packt.com and as a print book customer, you are entitled to a discount on the eBook copy. Get in touch with us at customer-care@packtpub.com for more details.

At www.packt.com, you can also read a collection of free technical articles, sign up for a range of free newsletters, and receive exclusive discounts and offers on Packt books and eBooks.

Contributors

About the author

Anghel Leonard is a Chief Technology Strategist with more than 20 years of experience in the Java ecosystem. In his daily work, he is focused on architecting and developing Java distributed applications that empower robust architectures, clean code, and high performance. He is also passionate about coaching, mentoring, and technical leadership.

He is the author of several books, videos, and dozens of articles related to Java technologies.

About the reviewers

Cristian Stancalau has an MSc and BSc in computer science and engineering from Babes-Bolyai University, where he has contributed as an assistant lecturer since 2018. Currently, he works as chief software architect, focused on enterprise code review at DevFactory.

Previously, he co-founded and lead a video technology start-up as technical director. Cristian has proven mentoring and teaching expertise in both the commercial and academic sectors, advising on Java technologies and product architecture.

I would like to thank Anghel Leonard for the honor of entrusting me to perform the technical review for Java Coding Problems. Reading it was a real pleasure for me and I am sure it will also be for his readers.

Vishnu Govindrao Kulkarni is an enthusiastic freelancer solutions provider (with Fortune Consulting). He has a wide range of experience in various domains, with 8 years of experience working with full-stack Java, Java Spring, Spring Boot, the Hibernate REST API, and Oracle. He has also had the opportunity to work with several organizations to build enterprise solutions using Java and Java frameworks. Today, he continues to design and develop solutions while closely working with clients to help them derive value from these solutions.

Previously, he worked as the technical reviewer for the book *Java Fundamentals* for Packt Publishing.

Packt is searching for authors like you

If you're interested in becoming an author for Packt, please visit authors.packtpub.com and apply today. We have worked with thousands of developers and tech professionals, just like you, to help them share their insight with the global tech community. You can make a general application, apply for a specific hot topic that we are recruiting an author for, or submit your own idea.

Table of Contents

Preface	1
Chapter 1: Strings, Numbers, and Math	8
Problems	8
Solutions	11
1. Counting duplicate characters	11
What about Unicode characters?	12
2. Finding the first non-repeated character	14
3. Reversing letters and words	17
4. Checking whether a string contains only digits	18
5. Counting vowels and consonants	19
6. Counting the occurrences of a certain character	21
7. Converting a string into an int, long, float, or double	23
8. Removing white spaces from a string	24
9. Joining multiple strings with a delimiter	24
10. Generating all permutations	26
11. Checking whether a string is a palindrome	28
12. Removing duplicate characters	30
13. Removing a given character	32
14. Finding the character with the most appearances	33
15. Sorting an array of strings by length	36
16. Checking that a string contains a substring	37
17. Counting substring occurrences in a string	38
18. Checking whether two strings are anagrams	40
19. Declaring multiline strings (text blocks)	41
20. Concatenating the same string n times	43
21. Removing leading and trailing spaces	45
22. Finding the longest common prefix	45
23. Applying indentation	47
24. Transforming strings	49
25. Computing the minimum and maximum of two numbers	50
26. Summing two large int/long values and operation overflow	51
27. String as an unsigned number in the radix	52
28. Converting into a number by an unsigned conversion	53
29. Comparing two unsigned numbers	54
30. Division and modulo of unsigned values	55
31. double/float is a finite floating-point value	56
32. Applying logical AND/OR/XOR to two boolean expressions	57
33. Converting BigInteger into a primitive type	58
34. Converting long into int	59

35. Computing the floor of a division and modulus	60
36. Next floating-point value	61
37. Multiplying two large int/long values and operation overflow	62
38. Fused Multiply Add	64
39. Compact number formatting	65
Formatting	65
Parsing	68
Summary	69
Chapter 2: Objects, Immutability, and Switch Expressions	70
Problems	70
Solutions	72
40. Checking null references in functional style and imperative code	72
41. Checking null references and throwing customized NullPointerException	75
42. Checking null references and throwing the specified exception	77
43. Checking null references and returning non-null default references	79
44. Checking the index in the range from 0 to length	80
45. Checking the subrange in the range from 0 to length	83
46. equals() and hashCode()	85
47. Immutable objects in a nutshell	91
48. Immutable string	91
Pros of string immutability	92
String constant pool or cached pool	92
Security	94
Thread safety	94
Hash code caching	94
Class loading	94
Cons of string immutability	95
String cannot be extended	95
Sensitive data in memory for a long time	95
OutOfMemoryError	95
Is String completely immutable?	95
49. Writing an immutable class	96
50. Passing/returning mutable objects to/from an immutable class	97
51. Writing an immutable class via the Builder pattern	100
52. Avoiding bad data in immutable objects	103
53. Cloning objects	105
Manual cloning	105
Cloning via clone()	106
Cloning via a constructor	107
Cloning via the Cloning library	108
Cloning via serialization	109
Cloning via JSON	110
54. Overriding toString()	110
55. Switch expressions	112
56. Multiple case labels	115
57. Statement blocks	116

Summary	117
Chapter 3: Working with Date and Time	118
Problems	118
Solutions	120
58. Converting a string to date and time	120
Before JDK 8	120
Starting with JDK 8	120
59. Formatting date and time	124
60. Getting the current date/time without time/date	128
61. LocalDateTime from LocalDate and LocalTime	128
62. Machine time via an Instant class	129
Converting String to Instant	130
Adding or subtracting time to/from Instant	130
Comparing Instant objects	130
Converting between Instant and LocalDateTime, ZonedDateTime, and OffsetDateTime	131
63. Defining a period of time using date-based values and a duration of time using time-based values	132
Period of time using date-based values	132
Duration of time using time-based values	134
64. Getting date and time units	137
65. Adding and subtracting to/from date-time	138
Working with Date	139
Working with LocalDateTime	139
66. Getting all time zones with UTC and GMT	140
Before JDK 8	140
Starting with JDK 8	140
67. Getting local date-time in all available time zones	142
Before JDK 8	142
Starting with JDK 8	143
68. Displaying date-time information about a flight	144
69. Converting a Unix timestamp to date-time	145
70. Finding the first/last day of the month	146
71. Defining/extracting zone offsets	149
Before JDK 8	150
Starting with JDK 8	150
72. Converting between Date and Temporal	151
Date – Instant	152
Date – LocalDate	153
Date – DateLocalTime	154
Date – ZonedDateTime	154
Date – OffsetDateTime	155
Date – LocalTime	155
Date – OffsetTime	156
73. Iterating a range of dates	156
Before JDK 8	156
Starting with JDK 8	157

Starting with JDK 9	157
74. Calculating age	158
Before JDK 8	158
Starting with JDK 8	158
75. Start and end of a day	159
76. Difference between two dates	162
Before JDK 8	162
Starting with JDK 8	162
77. Implementing a chess clock	164
Summary	169
Chapter 4: Type Inference	170
Problems	170
Solutions	172
78. Simple var example	172
79. Using var with primitive types	175
80. Using var and implicit type casting to sustain the code's maintainability	176
81. Explicit downcast or better avoid var	178
82. Avoid using var if the called names don't contain enough type information for humans	179
83. Combining LVTI and programming to the interface technique	180
84. Combining LVTI and the diamond operator	181
85. Assigning an array to var	183
86. Using LVTI in compound declarations	184
87. LVTI and variable scope	184
88. LVTI and the ternary operator	186
89. LVTI and for loops	187
90. LVTI and streams	188
91. Using LVTI to break up nested/large chains of expressions	189
92. LVTI and the method return and argument types	190
93. LVTI and anonymous classes	191
94. LVTI can be final and effectively final	192
95. LVTI and lambdas	193
96. LVTI and null initializers, instance variables, and catch blocks variables	194
Try-with-resource	195
97. LVTI and generic types, T	195
98. LVTI, wildcards, covariants, and contravariants	196
LVTI and wildcards	197
LVTI and covariants/contravariants	197
Summary	198
Chapter 5: Arrays, Collections, and Data Structures	199
Problems	199
Solutions	201
99. Sorting an array	201

JDK built-in solutions	201
Other sorting algorithms	204
Bubble sort	204
Insertion sort	206
Counting sort	209
Heap sort	210
100. Finding an element in an array	215
Check only for the presence	215
Check only for the first index	219
101. Checking whether two arrays are equal or mismatches	220
Checking whether two arrays are equal	221
Checking whether two arrays contain a mismatch	222
102. Comparing two arrays lexicographically	224
103. Creating a Stream from an array	227
104. Minimum, maximum, and average of an array	228
Computing maximum and minimum	228
Computing average	231
105. Reversing an array	232
106. Filling and setting an array	233
107. Next Greater Element	236
108. Changing array size	237
109. Creating unmodifiable/immutable collections	238
Problem 1 (Collections.unmodifiableList())	239
Problem 2 (Arrays.asList())	240
Problem 3 (Collections.unmodifiableList() and static block)	240
Problem 4 (List.of())	241
Problem 5 (immutable)	242
110. Mapping a default value	245
111. Computing whether absent/present in a map	246
Example 1 (computeIfPresent())	246
Example 2 (computeIfAbsent())	247
Example 3 (compute())	249
Example 4 (merge())	250
Example 5 (putIfAbsent())	251
112. Removal from a Map	252
113. Replacing entries from a Map	253
114. Comparing two maps	255
115. Sorting a Map	256
Sorting by key via TreeMap and natural ordering	257
Sorting by key and value via Stream and Comparator	257
Sorting by key and value via List	258
116. Copying HashMap	259
117. Merging two maps	260
118. Removing all elements of a collection that match a predicate	262
Removing via an iterator	263
Removing via Collection.removeIf()	263
Removing via Stream	263
Separating elements via Collectors.partitioningBy()	264
119. Converting a collection into an array	265

120. Filtering a Collection by a List	265
121. Replacing elements of a List	267
122. Thread-safe collections, stacks, and queues	269
Concurrent collections	269
Thread-safe lists	269
Thread-safe set	270
Thread-safe map	270
Thread-safe queue backed by an array	271
Thread-safe queue based on linked nodes	272
Thread-safe priority queue	272
Thread-safe delay queue	272
Thread-safe transfer queue	273
Thread-safe synchronous queue	273
Thread-safe stack	273
Synchronized collections	274
Concurrent versus synchronized collections	274
123. Breadth-first search	275
124. Trie	277
Inserting in a Trie	279
Finding in a Trie	280
Deleting from a Trie	281
125. Tuple	282
126. Union Find	284
Implementing the find operation	287
Implementing the union operation	287
127. Fenwick Tree or Binary Indexed Tree	289
128. Bloom filter	293
Summary	296
Chapter 6: Java I/O Paths, Files, Buffers, Scanning, and Formatting	297
Problems	297
Solutions	299
129. Creating file paths	299
Creating a path relative to the file store root	300
Creating a path relative to the current folder	301
Creating an absolute path	301
Creating a path using shortcuts	302
130. Converting file paths	303
131. Joining file paths	305
132. Constructing a path between two locations	306
133. Comparing file paths	307
Path.equals()	308
Paths representing the same file/folder	308
Lexicographical comparison	309
Partial comparing	309
134. Walking paths	309
Trivial traversal of a folder	310
Searching for a file by name	312

Deleting a folder	314
Copying a folder	315
JDK 8, Files.walk()	318
135. Watching paths	319
Watching a folder for changes	320
136. Streaming a file's content	323
137. Searching for files/folders in a file tree	324
138. Reading/writing text files efficiently	326
Reading text files in memory	331
Writing text files	332
139. Reading/writing binary files efficiently	333
Reading binary files into memory	336
Writing binary files	337
140. Searching in big files	338
Solution based on BufferedReader	339
Solution based on Files.readAllLines()	339
Solution based on Files.lines()	340
Solution based on Scanner	340
Solution based on MappedByteBuffer	341
141. Reading a JSON/CSV file as an object	342
Read/write a JSON file as an object	342
Using JSON-B	343
Using Jackson	344
Using Gson	346
Reading a CSV file as an object	346
142. Working with temporary files/folders	347
Creating a temporary folder/file	348
Deleting a temporary folder/file via shutdown-hook	349
Deleting a temporary folder/file via deleteOnExit()	350
Deleting a temporary file via DELETE_ON_CLOSE	351
143. Filtering files	352
Filtering via Files.newDirectoryStream()	352
Filtering via FilenameFilter	355
Filtering via FileFilter	355
144. Discovering mismatches between two files	356
145. Circular byte buffer	358
146. Tokenizing files	366
147. Writing formatted output directly to a file	371
148. Working with Scanner	374
Scanner versus BufferedReader	378
Summary	378
Chapter 7: Java Reflection Classes, Interfaces, Constructors, Methods, and Fields	379
Problems	379
Solutions	381
149. Inspecting packages	381
Getting the classes of a package	382

Inspecting packages inside modules	385
150. Inspecting classes	386
Get the name of the Pair class via an instance	386
Getting the Pair class modifiers	387
Getting the Pair class implemented interfaces	387
Getting the Pair class constructors	388
Getting the Pair class fields	388
Getting the Pair class methods	389
Getting the Pair class module	390
Getting the Pair class superclass	390
Getting the name of a certain type	390
Getting a string that describes the class	392
Getting the type descriptor string for a class	392
Getting the component type of an array	392
Getting a class for an array type whose component type is described by Pair	393
151. Instantiating via a reflected constructor	393
Instantiating a class via a private constructor	395
Instantiating a class from a JAR	396
Useful snippets of code	397
152. Getting the annotation of a receiver type	398
153. Getting synthetic and bridge constructs	399
154. Checking the variable number of arguments	401
155. Checking default methods	402
156. Nest-based access control via reflection	402
Access via the Reflection API	404
157. Reflection for getters and setters	406
Fetching getters and setters	407
Generating getters and setters	409
158. Reflecting annotations	414
Inspecting package annotations	415
Inspecting class annotations	415
Inspecting methods annotations	416
Inspecting annotations of the thrown exceptions	417
Inspecting annotations of the return type	417
Inspecting annotations of the method's parameters	418
Inspecting annotations of fields	419
Inspecting annotations of the superclass	419
Inspecting annotations of interfaces	420
Get annotations by type	421
Get a declared annotation	421
159. Invoking an instance method	421
160. Getting static methods	422
161. Getting generic types of method, fields, and exceptions	424
Generics of methods	425
Generics of fields	426
Generics of a superclass	426
Generics of interfaces	427
Generics of exceptions	427

162. Getting public and private fields	428
163. Working with arrays	429
164. Inspecting modules	430
165. Dynamic proxies	432
Implementing a dynamic proxy	433
Summary	436
Chapter 8: Functional Style Programming - Fundamentals and Design Patterns	437
Problems	437
Solutions	438
166. Writing functional interfaces	438
Day 1 (filtering melons by their type)	439
Day 2 (filtering melons of a certain weight)	440
Day 3 (filtering melons by type and weight)	440
Day 4 (pushing the behavior as a parameter)	441
Day 5 (implementing another 100 filters)	443
Day 6 (anonymous classes can be written as lambdas)	444
Day 7 (abstracting the List type)	445
167. Lambdas in a nutshell	447
168. Implementing the Execute Around pattern	448
169. Implementing the Factory pattern	450
170. Implementing the Strategy pattern	452
171. Implementing the Template Method pattern	454
172. Implementing the Observer pattern	456
173. Implementing the Loan pattern	459
174. Implementing the Decorator pattern	462
175. Implementing the Cascaded Builder pattern	466
176. Implementing the Command pattern	467
Summary	471
Chapter 9: Functional Style Programming - a Deep Dive	472
Problems	472
Solutions	474
177. Testing high-order functions	474
Testing a method that takes a lambda as a parameter	474
Testing a method that returns a functional interface	475
178. Testing methods that use lambdas	476
179. Debugging lambdas	478
180. Filtering the non-zero elements of a stream	482
181. Infinite streams, takeWhile(), and dropWhile()	484
Infinite sequential ordered stream	485
Unlimited stream of pseudorandom values	487
Infinite sequential unordered stream	489
Take while a predicate returns true	489
Drop while a predicate returns true	491
182. Mapping the elements of a stream	493

Using Stream.map()	494
Using Stream.flatMap()	497
183. Finding elements in a stream	500
findAny	501
findFirst	501
184. Matching elements in a stream	503
185. Sum, max, and min in a stream	504
The sum(), min(), and max() terminal operations	505
Reducing	506
186. Collecting the result of a stream	509
187. Joining the results of a stream	513
188. Summarization collectors	514
Summing	514
Averaging	516
Counting	517
Maximum and minimum	517
Getting all	518
189. Grouping	518
Single-level grouping	519
Multilevel grouping	526
190. Partitioning	528
191. Filtering, flattening, and mapping collectors	531
filtering()	532
mapping()	533
flatMaping()	534
192. Teeing	535
193. Writing a custom collector	538
The supplier – Supplier<A> supplier();	541
Accumulating elements – BiConsumer<A, T> accumulator();	541
Applying the final transformation – Function<A, R> finisher();	542
Parallelizing the collector – BinaryOperator<A> combiner();	542
Returning the final result – Function<A, R> finisher();	543
Characteristics – Set<Characteristics> characteristics();	543
Testing time	543
Custom collecting via collect()	544
194. Method reference	545
Method reference to a static method	545
Method reference to an instance method	546
Method reference to a constructor	547
195. Parallel processing of streams	547
Spliterators	551
Writing a custom Spliterator	553
196. Null-safe streams	554
197. Composing functions, predicates, and comparators	556
Composing predicates	556
Composing comparators	558
Composing functions	560
198. Default methods	562

Summary	563
Chapter 10: Concurrency - Thread Pools, Callables, and Synchronizers	564
Problems	564
Solutions	566
199. Thread life cycle states	566
The NEW state	567
The RUNNABLE state	567
The BLOCKED state	568
The WAITING state	570
The TIMED_WAITING state	571
The TERMINATED state	572
200. Object- versus class-level locking	573
Locking at the object level	573
Lock at the class level	574
Good to know	575
201. Thread pools in Java	576
Executor	576
ExecutorService	577
ScheduledExecutorService	579
Thread pools via Executors	580
202. Thread pool with a single thread	581
Producer waits for the consumer to be available	582
Producer doesn't wait for the consumer to be available	588
203. Thread pool with a fixed number of threads	589
204. Cached and scheduled thread pools	591
205. Work-stealing thread pool	598
A large number of small tasks	601
A small number of time-consuming tasks	603
206. Callable and Future	604
Canceling a Future	609
207. Invoking multiple Callable tasks	610
208. Latches	613
209. Barrier	616
210. Exchanger	621
211. Semaphores	624
212. Phasers	628
Summary	633
Chapter 11: Concurrency - Deep Dive	634
Problems	634
Solutions	635
213. Interruptible methods	636
214. Fork/join framework	639
Computing the sum via RecursiveTask	641
Computing Fibonacci via RecursiveAction	643
Using CountedCompleter	645

215. Fork/join framework and compareAndSetForkJoinTaskTag()	648
216. CompletableFuture	651
Running asynchronous task and return void	652
Running an asynchronous task and returning a result	653
Running an asynchronous task and returning a result via an explicit thread pool	653
Attaching a callback that processes the result of an asynchronous task and returns a result	654
Attaching a callback that processes the result of an asynchronous task and returns void	656
Attaching a callback that runs after an asynchronous task and returns void	657
Handling exceptions of an asynchronous task via exceptionally()	658
JDK 12 exceptionallyCompose()	664
Handling exceptions of an asynchronous task via handle()	665
Explicitly complete a CompletableFuture	667
217. Combining multiple CompletableFuture instances	668
Combining via thenCompose()	668
Combining via thenCombine()	670
Combining via allOf()	671
Combining via anyOf()	672
218. Optimizing busy waiting	674
219. Task Cancellation	675
220. ThreadLocal	677
Per-thread instances	677
Per-thread context	680
221. Atomic variables	682
Adders and accumulators	685
222. ReentrantLock	687
223. ReentrantReadWriteLock	690
224. StampedLock	693
225. Deadlock (dining philosophers)	697
Summary	701
Chapter 12: Optional	702
Problems	702
Solutions	704
226. Initializing Optional	705
227. Optional.get() and missing value	705
228. Returning an already-constructed default value	706
229. Returning a non-existent default value	707
230. Throwing NoSuchElementException	708
231. Optional and null references	709
232. Consuming a present Optional class	710
233. Returning a present Optional class or another one	712
234. Chaining lambdas via orElseFoo()	712
235. Do not use Optional just for getting a value	715
236. Do not use Optional for fields	715

237. Do not use Optional in constructor args	716
238. Do not use Optional in setter args	718
239. Do not use Optional in method args	719
240. Do not use Optional to return empty or null collections or arrays	721
241. Avoiding Optional in collections	722
242. Confusing of() with ofNullable()	724
243. Optional<T> versus OptionalInt	725
244. Asserting equality of Optionals	726
245. Transforming values via Map() and flatMap()	727
246. Filter values via Optional.filter()	729
247. Chaining the Optional and Stream APIs	730
248. Optional and identity-sensitive operations	731
249. Returning a boolean if the Optional class is empty	733
Summary	734
Chapter 13: The HTTP Client and WebSocket APIs	735
Problems	735
Solutions	737
250. HTTP/2	737
251. Triggering an asynchronous GET request	738
Query parameter builder	740
252. Setting a proxy	741
253. Setting/getting headers	741
Setting request headers	741
Getting request/response headers	743
254. Specifying the HTTP method	744
255. Setting a request body	745
Creating a body from a string	746
Creating a body from InputStream	746
Creating a body from a byte array	747
Creating a body from a file	747
256. Setting connection authentication	747
257. Setting a timeout	749
258. Setting the redirect policy	749
259. Sending sync and async requests	750
Sending a request synchronously	751
Sending a request asynchronously	751
Sending multiple requests concurrently	752
260. Handling cookies	753
261. Getting response information	754
262. Handling response body types	755
Handling a response body as a string	755
Handling a response body as a file	756
Handling a response body as a byte array	756
Handling a response body as an input stream	756
Handling a response body as a stream of strings	757
263. Getting, updating, and saving a JSON	757

Table of Contents

JSON response to User	759
Updated User to JSON request	759
New User to JSON request	760
264. Compression	760
265. Handling form data	762
266. Downloading a resource	763
267. Uploading with multipart	764
268. HTTP/2 server push	767
269. WebSocket	771
Summary	773
Other Books You May Enjoy	774
Index	777

Preface

The super-fast evolution of the JDK between versions 8 and 12 has increased the learning curve of modern Java, therefore has increased the time needed for placing developers in the Plateau of Productivity. Its new features and concepts can be adopted to solve a variety of modern-day problems. This book enables you to adopt an objective approach to common problems by explaining the correct practices and decisions with respect to complexity, performance, readability, and more.

Java Coding Problems will help you complete your daily tasks and meet deadlines. You can count on the 300+ applications containing 1,000+ examples in this book to cover the common and fundamental areas of interest: strings, numbers, arrays, collections, data structures, date and time, immutability, type inference, `Optional`, Java I/O, Java Reflection, functional programming, concurrency and the HTTP Client API. Put your skills on steroids with problems that have been carefully crafted to highlight and cover the core knowledge that is accessed in daily work. In other words (no matter if your task is easy, medium or complex) having this knowledge under your tool belt is a must, not an option.

By the end of this book, you will have gained a strong understanding of Java concepts and have the confidence to develop and choose the right solutions to your problems.

Who this book is for

Java Coding Problems is especially useful for beginners and intermediate Java developers. However, the problems looked at here are encountered in the daily work of any Java developer.

The required technical background is quite thin. Mainly, you should be a Java fan and have good skills and intuition in following a piece of Java code.

What this book covers

Chapter 1, *Strings, Numbers, and Math*, includes 39 problems that involve strings, numbers, and mathematical operations. The chapter starts with a bunch of classical problems for strings such as counting duplicates, reversing a string, and removing white spaces. The chapter continues with problems dedicated to numbers and mathematical operations such as summing two large numbers, operation overflow, comparing two unsigned numbers, computing the floor of a division and a modulus, and much more. Each problem is passed through several solutions, including Java 8 functional style. Moreover, the chapter covers problems that futures added in JDK 9, 10, 11, and 12.

Chapter 2, *Objects, Immutability, and Switch Expressions*, includes 18 problems that involve objects, immutability, and `switch` expressions. The chapter starts with several problems about dealing with `null` references. It continues with problems regarding checking indexes, `equals()` and `hashCode()`, and immutability (for example, writing immutable classes and passing/returning mutable objects from immutable classes). The last part of the chapter deals with cloning objects and JDK 12 `switch` expressions.

Chapter 3, *Working with Date and Time*, includes 20 problems that involve date and time. These problems are meant to cover a wide range of topics (converting, formatting, adding, subtracting, defining periods/durations, computing, and so on) via `Date`, `Calendar`, `LocalDate`, `LocalTime`, `LocalDateTime`, `ZoneDateTime`, `OffsetDateTime`, `OffsetTime`, `Instant`, and so on. By the end of this chapter, you will have no problems shaping date and time to conform to your application's needs.

Chapter 4, *Type Inference*, includes 21 problems that involve JEP 286, Java **Local Variable Type Inference (LVTI)**, or the `var` type. These problems have been carefully crafted to reveal the best practices and common mistakes involved in using `var`. By the end of this chapter, you will have everything you need to know about `var` to push it in production.

Chapter 5, *Arrays, Collections, and Data Structures*, includes 30 problems that involve arrays, collections, and several data structures. The aim is to provide solutions to a category of problems encountered in a wide range of applications, such as sorting, finding, comparing, ordering, reversing, filling, merging, copying, replacing, and so on. The provided solutions are implemented in Java 8-12 and they can be used as the base for solving other related problems as well. By the end of this chapter, you will have a solid base of knowledge that's useful for solving a lot of problems that involve arrays, collections, and data structures.

Chapter 6, *Java I/O Paths, Files, Buffers, Scanning, and Formatting*, includes 20 problems that involve Java I/O for files. From manipulating, walking, and watching paths to streaming files and efficient ways for reading/writing text and binary files, we will cover problems that are a must in the arsenal of any Java developer. With the skills gained from this chapter, you will be able to tackle most of the common problems that involve Java I/O files.

Chapter 7, *Java Reflection Classes, Interfaces, Constructors, Methods, and Fields*, includes 17 problems that involve the Java Reflection API. From classical topics, such as inspecting and instantiating Java artifacts (for example, modules, packages, classes, interfaces, super-classes, constructors, methods, annotations, arrays, and so on), to synthetic and bridge constructs or nest-based access control (JDK 11), this chapter provides solid coverage of the Java Reflection API.

Chapter 8, *Functional Style Programming – Fundamentals and Design Patterns*, includes 11 problems that involve Java functional programming. The chapter starts with a problem designed to acquaint you completely with functional interfaces. It continues with a suite of design patterns from GoF interpreted in Java functional style.

Chapter 9, *Functional Style Programming – Deep Dive*, includes 22 problems that involve Java functional programming. Here, we focus on several problems that involve classical operations encountered in streams (for example, filters, and maps), and we discuss infinite streams, null-safe streams, and default methods. A comprehensive list of problems covers grouping, partitioning, and collectors, including the JDK 12 `teeing()` collector and the matter of writing a custom collector. In addition, `takeWhile()`, `dropWhile()`, composing functions, predicates and comparators, testing and debugging lambdas, and other cool topics are discussed as well.

Chapter 10, *Concurrency – Thread Pools, Callables, and Synchronizers*, includes 14 problems that involve Java concurrency. This chapter starts with several fundamental problems about the thread life cycle and object-/class-level locking. It continues with a bunch of problems about thread pools in Java, including JDK 8 work-stealing thread pools. Afterward, we have problems dedicated to `Callable` and `Future`. Next, we dedicate several problems to Java synchronizers (for example, barrier, semaphore, and exchanger). By the end of this chapter, you should be familiar with the main coordinates of Java concurrency and be ready to continue with a set of advanced problems.

Chapter 11, *Concurrency – Deep Dive*, includes 13 problems that involve Java concurrency. This chapter covers problems about fork/join frameworks, `CompletableFuture`, `ReentrantLock`, `ReentrantReadWriteLock`, `StampedLock`, atomic variables, task cancelation, interruptible methods, thread-local locks, and deadlocks. Completing this chapter will guarantee the achievement of the considerable amount of concurrency knowledge needed by any Java developer.

Chapter 12, *Optional*, includes 24 problems meant to draw several rules for working with `Optional`. The problems and solutions presented in this section are based on the Brian Goetz' (Java's language architect) definition—*Optional is intended to provide a limited mechanism for library method return types where there needed to be a clear way to represent no result, and using null for such was overwhelmingly likely to cause errors*. But where there are rules, there are exceptions as well. Therefore, do not conclude that the rules (or practices) presented here should be followed (or avoided) at all costs. Like always, the solution depends on the problem.

Chapter 13, *HTTP Client and WebSocket APIs*, includes 20 problems meant to cover the HTTP Client and WebSocket APIs. Remember `URLConnection`? Well, JDK 11 comes with the HTTP Client API as a reinvention of `URLConnection`. The HTTP Client API is easy to use and supports HTTP/2 (default) and HTTP/1.1. For backward compatibility, the HTTP Client API will automatically downgrade from HTTP/2 to HTTP 1.1 when the server doesn't support HTTP/2. Moreover, the HTTP Client API supports synchronous and asynchronous programming models and relies on streams to transfer data (reactive streams). It also supports the WebSocket protocol used in real-time web applications to provide client-server communication with low message overhead.

To get the most out of this book

You should have fundamental knowledge about the Java language. You should install the following:

- An IDE (recommended, but not a must, is Apache NetBeans 11.x: <https://netbeans.apache.org/>)
- JDK 12 and Maven 3.3.x
- Additional third-party libraries will need to be installed at the right moment (nothing special)

Download the example code files

You can download the example code files for this book from your account at www.packt.com. If you purchased this book elsewhere, you can visit www.packtpub.com/support and register to have the files emailed directly to you.

You can download the code files by following these steps:

1. Log in or register at www.packt.com.
2. Select the **Support** tab.
3. Click on **Code Downloads**.
4. Enter the name of the book in the **Search** box and follow the onscreen instructions.

Once the file is downloaded, please make sure that you unzip or extract the folder using the latest version of:

- WinRAR/7-Zip for Windows
- Zipeg/iZip/UnRarX for Mac
- 7-Zip/PeaZip for Linux

The code bundle for the book is also hosted on GitHub at <https://github.com/PacktPublishing/Java-Coding-Problems>. In case there's an update to the code, it will be updated on the existing GitHub repository.

We also have other code bundles from our rich catalog of books and videos available at <https://github.com/PacktPublishing/>. Check them out!

Download the color images

We also provide a PDF file that has color images of the screenshots/diagrams used in this book. You can download it here: https://static.packt-cdn.com/downloads/9781789801415_ColorImages.pdf.

Code in action

To see the code being executed please visit the following link: <http://bit.ly/2kSgFKf>.

Conventions used

There are a number of text conventions used throughout this book.

CodeInText: Indicates code words in text, database table names, folder names, filenames, file extensions, pathnames, dummy URLs, user input, and Twitter handles. Here is an example: "If the current character exists in the `Map` instance, then simply increase its occurrences by 1 with `(character, occurrences+1)`."

A block of code is set as follows:

```
public Map<Character, Integer> countDuplicateCharacters(String str) {  
  
    Map<Character, Integer> result = new HashMap<>();  
  
    // or use for(char ch: str.toCharArray()) { ... }  
    for (int i = 0; i<str.length(); i++) {  
        char ch = str.charAt(i);  
  
        result.compute(ch, (k, v) -> (v == null) ? 1 : ++v);  
    }  
  
    return result;  
}
```

When we wish to draw your attention to a particular part of a code block, the relevant lines or items are set in bold:

```
for (int i = 0; i < str.length(); i++) {  
    int cp = str.codePointAt(i);  
    String ch = String.valueOf(Character.toChars(cp));  
    if (Character.charCount(cp) == 2) { // 2 means a surrogate pair  
        i++;  
    }  
}
```

Any command-line input or output is written as follows:

```
$ mkdir css  
$ cd css
```

Bold: Indicates a new term, an important word, or words that you see onscreen. For example, words in menus or dialog boxes appear in the text like this. Here is an example: "In Java, the logical **AND** operator is represented as `&&`, the logical **OR** operator is represented as `||`, and the logical **XOR** operator is represented as `^`."



Warnings or important notes appear like this.



Tips and tricks appear like this.

Get in touch

Feedback from our readers is always welcome.

General feedback: If you have questions about any aspect of this book, mention the book title in the subject of your message and email us at customercare@packtpub.com.

Errata: Although we have taken every care to ensure the accuracy of our content, mistakes do happen. If you have found a mistake in this book, we would be grateful if you would report this to us. Please visit www.packtpub.com/support/errata, selecting your book, clicking on the Errata Submission Form link, and entering the details.

Piracy: If you come across any illegal copies of our works in any form on the Internet, we would be grateful if you would provide us with the location address or website name. Please contact us at copyright@packt.com with a link to the material.

If you are interested in becoming an author: If there is a topic that you have expertise in and you are interested in either writing or contributing to a book, please visit authors.packtpub.com.

Reviews

Please leave a review. Once you have read and used this book, why not leave a review on the site that you purchased it from? Potential readers can then see and use your unbiased opinion to make purchase decisions, we at Packt can understand what you think about our products, and our authors can see your feedback on their book. Thank you!

For more information about Packt, please visit packt.com.

1 Strings, Numbers, and Math

This chapter includes 39 problems that involve strings, numbers, and mathematical operations. We will start by looking at a bunch of classical problems for strings such as counting duplicates, reversing a string, and removing white spaces. Then, we will look at problems dedicated to numbers and mathematical operations such as summing two large numbers and operation overflow, comparing two unsigned numbers, and computing the floor of a division and modulus. Each problem is passed through several solutions, including Java 8's functional style. Moreover, we will be covering problems that concern JDK 9, 10, 11, and 12.

By the end of this chapter, you will know how to use a bunch of techniques so that you can manipulate strings and apply, adapt, and adjust them to many other problems. You will also know how to solve mathematical corner cases that may lead to weird and unpredictable results.

Problems

Use the following problems to test your string manipulation and mathematical corner case programming prowess. I strongly encourage you to give each problem a try before you turn to the solutions and download the example programs:

1. **Counting duplicate characters:** Write a program that counts duplicate characters from a given string.
2. **Finding the first non-repeated character:** Write a program that returns the first non-repeated character from a given string.
3. **Reversing letters and words:** Write a program that reverses the letters of each word and a program that reverses the letters of each word and the words themselves.
4. **Checking whether a string contains only digits:** Write a program that checks whether the given string contains only digits.

5. **Counting vowels and consonants:** Write a program that counts the number of vowels and consonants in a given string. Do this for the English language, which has five vowels (a, e, i, o, and u).
6. **Counting occurrences of a certain character:** Write a program that counts the occurrences of a certain character in a given string.
7. **Converting String into int, long, float, or double:** Write a program that converts the given String object (representing a number) into int, long, float, or double.
8. **Removing white spaces from a string:** Write a program that removes all white spaces from the given string.
9. **Joining multiple strings with a delimiter:** Write a program that joins the given strings by the given delimiter.
10. **Generating all permutations:** Write a program that generates all of the permutations of a given string.
11. **Checking whether a string is a palindrome:** Write a program that determines whether the given string is a palindrome or not.
12. **Removing duplicate characters:** Write a program that removes the duplicate characters from the given string.
13. **Removing given characters:** Write a program that removes the given character from the given string.
14. **Finding the character with the most appearances:** Write a program that finds the character with the most appearances in the given string.
15. **Sorting an array of strings by length:** Write a program that sorts by the length of the given array of strings.
16. **Checking that a string contains a substring:** Write a program that checks whether the given string contains the given substring.
17. **Counting substring occurrences a string:** Write a program that counts the occurrences of a given string in another given string.
18. **Checking whether two strings are anagrams:** Write a program that checks whether two strings are anagrams. Consider that an anagram of a string is a permutation of this string by ignoring capitalization and white spaces.
19. **Declaring multiline strings (text blocks):** Write a program that declares multiline strings or text blocks.
20. **Concatenating the same string n times:** Write a program that concatenates the same string a given number of times.
21. **Removing leading and trailing spaces:** Write a program that removes the leading and trailing spaces of the given string.

22. **Finding the longest common prefix:** Write a program that finds the longest common prefix of given strings.
23. **Applying indentation:** Write several snippets of code to apply indentation to the given text.
24. **Transforming strings:** Write several snippets of code to transform a string into another string.
25. **Computing the minimum and maximum of two numbers:** Write a program that returns the minimum and maximum of two numbers.
26. **Summing two large `int/long` numbers and operation overflow:** Write a program that sums two large `int/long` numbers and throws an arithmetic exception in the case of an operation overflow.
27. **String as an unsigned number in the radix:** Write a program that parses the given string into an unsigned number (`int` or `long`) in the given radix.
28. **Converting into a number by an unsigned conversion:** Write a program that converts a given `int` number into `long` by an unsigned conversion.
29. **Comparing two unsigned numbers:** Write a program that compares the given two numbers as unsigned.
30. **Division and modulo of unsigned values:** Write a program that computes the division and modulo of the given unsigned value.
31. **`double/float` is a finite floating-point value:** Write a program that determines whether the given `double/float` value is a finite floating-point value.
32. **Applying logical AND/OR/XOR to two boolean expressions:** Write a program that applies the logical AND/OR/XOR to two boolean expressions.
33. **Converting `BigInteger` into a primitive type:** Write a program that extracts the primitive type value from the given `BigInteger`.
34. **Converting `long` into `int`:** Write a program that converts `long` into `int`.
35. **Computing the floor of a division and modulus:** Write a program that computes the floor division and the floor modulus of the given dividend (x) and divisor (y).
36. **Next floating-point value:** Write a program that returns the next floating-point adjacent to the given `float/double` value in the direction of positive and negative infinity.
37. **Multiplying two large `int/long` values and operation overflow:** Write a program that multiplies two large `int/long` values and throws an arithmetic exception in the case of operation overflow.

38. **Fused Multiply Add (FMA):** Write a program that takes three `float/double` values (a, b, c) and computes $a * b + c$ in an efficient way.
39. **Compact number formatting:** Write a program that formats the number 1,000,000 to 1M (US locale) and to 1 mln (Italian locale). In addition, parse 1M and 1 mln from a string into a number.

Solutions

The following sections describe solutions to the preceding problems. Remember that there usually isn't a single correct way to solve a particular problem. Also, remember that the explanations shown here only include the most interesting and important details needed to solve the problems. You can download the example solutions to see additional details and experiment with the programs from <https://github.com/PacktPublishing/Java-Coding-Problems>.

1. Counting duplicate characters

The solution to counting the characters in a string (including special characters such as #, \$, and %) implies taking each character and comparing them with the rest. During the comparison, the counting state is maintained via a numeric counter that's increased by one each time the current character is found.

There are two solutions to this problem.

The first solution iterates the string characters and uses `Map` to store the characters as keys and the number of occurrences as values. If the current character was never added to `Map`, then add it as `(character, 1)`. If the current character exists in `Map`, then simply increase its occurrences by 1, for example, `(character, occurrences+1)`. This is shown in the following code:

```
public Map<Character, Integer> countDuplicateCharacters(String str) {  
  
    Map<Character, Integer> result = new HashMap<>();  
  
    // or use for(char ch: str.toCharArray()) { ... }  
    for (int i = 0; i<str.length(); i++) {  
        char ch = str.charAt(i);  
  
        result.compute(ch, (k, v) -> (v == null) ? 1 : ++v);  
    }  
}
```

```
    return result;
}
```

Another solution relies on Java 8's stream feature. This solution has three steps. The first two steps are meant to transform the given string into `Stream<Character>`, while the last step is responsible for grouping and counting the characters. Here are the steps:

1. Call the `String.chars()` method on the original string. This will return `IntStream`. This `IntStream` contains an integer representation of the characters from the given string.
2. Transform `IntStream` into a stream of characters via the `mapToObj()` method (convert the integer representation into the human-friendly character form).
3. Finally, group the characters (`Collectors.groupingBy()`) and count them (`Collectors.counting()`).

The following snippet of code glues these three steps into a single method:

```
public Map<Character, Long> countDuplicateCharacters(String str) {
    Map<Character, Long> result = str.chars()
        .mapToObj(c -> (char) c)
        .collect(Collectors.groupingBy(c -> c, Collectors.counting()));
    return result;
}
```

What about Unicode characters?

We are pretty familiar with ASCII characters. We have unprintable control codes between 0-31, printable characters between 32-127, and extended ASCII codes between 128-255. But what about Unicode characters? Consider this section for each problem that requires that we manipulate Unicode characters.

So, in a nutshell, early Unicode versions contained characters with values less than 65,535 (0xFFFF). Java represents these characters using the 16-bit `char` data type. Calling `charAt(i)` works as expected as long as `i` doesn't exceed 65,535. But over time, Unicode has added more characters and the maximum value has reached 1,114,111 (0x10FFFF). These characters don't fit into 16 bits, and so 32-bit values (known as *code points*) were considered for the UTF-32 encoding scheme.

Unfortunately, Java doesn't support UTF-32! Nevertheless, Unicode has come up with a solution for still using 16 bits to represent these characters. This solution implies the following:

- 16-bit *high surrogates*: 1,024 values (U+D800 to U+DBFF)
- 16-bit *low surrogates*: 1,024 values (U+DC00 to U+DFFF)

Now, a high surrogate followed by a low surrogate defines what is known as a **surrogate pair**. Surrogate pairs are used to represent values between 65,536 (0x10000) and 1,114,111 (0x10FFFF). So, certain characters, known as Unicode supplementary characters, are represented as Unicode surrogate pairs (a one-character (symbol) fits in the space of a pair of characters) that are merged into a single code point. Java takes advantage of this representation and exposes it via a suite of methods such as `codePointAt()`, `codePoints()`, `codePointCount()`, and `offsetByCodePoints()` (take a look at the Java documentation for details). Calling `codePointAt()` instead of `charAt()`, `codePoints()` instead of `chars()`, and so on helps us to write solutions that cover ASCII and Unicode characters as well.

For example, the well-known two hearts symbol is a Unicode surrogate pair that can be represented as a `char[]` containing two values: `\uD83D` and `\uDC95`. The code point of this symbol is 128149. To obtain a `String` object from this code point, call `String str = String.valueOf(Character.toChars(128149))`. Counting the code points in `str` can be done by calling `str.codePointCount(0, str.length())`, which returns 1 even if the `str` length is 2. Calling `str.codePointAt(0)` returns 128149 and calling `str.codePointAt(1)` returns 56469. Calling `Character.toChars(128149)` returns 2 since two characters are needed to represent this code point being a Unicode surrogate pair. For ASCII and Unicode 16-bit characters, it will return 1.

So, if we try to rewrite the first solution (that iterates the string characters and uses `Map` to store the characters as keys and the number of occurrences as values) to support ASCII and Unicode (including surrogate pairs), we obtain the following code:

```
public static Map<String, Integer>
    countDuplicateCharacters(String str) {

    Map<String, Integer> result = new HashMap<>();

    for (int i = 0; i < str.length(); i++) {
        int cp = str.codePointAt(i);
        String ch = String.valueOf(Character.toChars(cp));
        if (Character.charCount(cp) == 2) { // 2 means a surrogate pair
```

```
        i++;
    }

    result.compute(ch, (k, v) -> (v == null) ? 1 : ++v);
}

return result;
}
```

The highlighted code can be written as follows, as well:

```
String ch = String.valueOf(Character.toChars(str.codePointAt(i)));
if (i < str.length() - 1 && str.codePointCount(i, i + 2) == 1) {
    i++;
}
```

Finally, trying to rewrite the Java 8 functional style solution to cover Unicode surrogate pairs can be done as follows:

```
public static Map<String, Long> countDuplicateCharacters(String str) {

    Map<String, Long> result = str.codePoints()
        .mapToObj(c -> String.valueOf(Character.toChars(c)))
        .collect(Collectors.groupingBy(c -> c, Collectors.counting()));

    return result;
}
```



For third-party library support, please consider
Guava: `Multiset<String>`.

Some of the following problems will provide solutions that cover ASCII, 16-bit Unicode, and Unicode surrogate pairs as well. They have been chosen arbitrarily, and so, by relying on these solutions, you can easily write solutions for problems that don't provide such a solution.

2. Finding the first non-repeated character

There are different solutions to finding the first non-repeated character in a string. Mainly, the problem can be solved in a single traversal of the string or in more complete/partial traversals.

In the single traversal approach, we populate an array that's meant to store the indexes of all of the characters that appear exactly once in the string. With this array, simply return the smallest index containing a non-repeated character:

```
private static final int EXTENDED_ASCII_CODES = 256;
...
public char firstNonRepeatedCharacter(String str) {

    int[] flags = new int[EXTENDED_ASCII_CODES];

    for (int i = 0; i < flags.length; i++) {
        flags[i] = -1;
    }

    for (int i = 0; i < str.length(); i++) {
        char ch = str.charAt(i);
        if (flags[ch] == -1) {
            flags[ch] = i;
        } else {
            flags[ch] = -2;
        }
    }

    int position = Integer.MAX_VALUE;

    for (int i = 0; i < EXTENDED_ASCII_CODES; i++) {
        if (flags[i] >= 0) {
            position = Math.min(position, flags[i]);
        }
    }

    return position == Integer.MAX_VALUE ?
        Character.MIN_VALUE : str.charAt(position);
}
```

This solution assumes that every character from the string is part of the extended ASCII table (256 codes). Having codes greater than 256 requires us to increase the size of the array accordingly (<http://www.alansofficespace.com/unicode/unicd99.htm>). The solution will work as long as the array size is not extended beyond the largest value of the `char` type, which is `Character.MAX_VALUE`, that is, 65,535. On the other hand, `Character.MAX_CODE_POINT` returns the maximum value of a Unicode code point, 1,114,111. To cover this range, we need another implementation based on `codePointAt()` and `codePoints()`.

Thanks to the single traversal approach, this is pretty fast. Another solution consists of looping the string for each character and counting the number of occurrences. Every second occurrence (duplicate) simply breaks the loop, jumps to the next character, and repeats the algorithm. If the end of the string is reached, then it returns the current character as the first non-repeatable character. This solution is available in the code bundled with this book.

Another solution that's presented here relies on `LinkedHashMap`. This Java map is an *insertion-order* map (it maintains the order in which the keys were inserted into the map) and is very convenient for this solution. `LinkedHashMap` is populated with characters as keys and the number of occurrences as values. Once `LinkedHashMap` is complete, it will return the first key that has a value equal to 1. Thanks to the *insertion-order* feature, this is the first non-repeatable character in the string:

```
public char firstNonRepeatedCharacter(String str) {

    Map<Character, Integer> chars = new LinkedHashMap<>();

    // or use for(char ch: str.toCharArray()) { ... }
    for (int i = 0; i < str.length(); i++) {
        char ch = str.charAt(i);

        chars.compute(ch, (k, v) -> (v == null) ? 1 : ++v);
    }

    for (Map.Entry<Character, Integer> entry: chars.entrySet()) {
        if (entry.getValue() == 1) {
            return entry.getKey();
        }
    }

    return Character.MIN_VALUE;
}
```

In the code bundled with this book, the aforementioned solution has been written in Java 8 functional style. Moreover, the functional style solution for supporting ASCII, 16-bit Unicode, and Unicode surrogate pairs is as follows:

```
public static String firstNonRepeatedCharacter(String str) {

    Map<Integer, Long> chs = str.codePoints()
        .mapToObj(cp -> cp)
        .collect(Collectors.groupingBy(Function.identity(),
            LinkedHashMap::new, Collectors.counting()));

    int cp = chs.entrySet().stream()
```

```
.filter(e -> e.getValue() == 1L)
.findFirst()
.map(Map.Entry::getKey)
.orElse(Integer.valueOf(Character.MIN_VALUE));

return String.valueOf(Character.toChars(cp));
}
```

To understand this code in more detail, please consider the *What about Unicode characters?* subsection of the *Counting duplicate characters* section.

3. Reversing letters and words

First, let's reverse only the letters of each word. The solution to this problem can exploit the `StringBuilder` class. The first step consists of splitting the string into an array of words using a white space as the delimiter (`String.split(" ")`). Furthermore, we reverse each word using the corresponding ASCII codes and append the result to `StringBuilder`. First, we split the given string by space. Then, we loop the obtained array of words and reverse each word by fetching each character via `charAt()` in reverse order:

```
private static final String WHITESPACE = " ";
...
public String reverseWords(String str) {

    String[] words = str.split(WHITESPACE);
    StringBuilder reversedString = new StringBuilder();

    for (String word: words) {
        StringBuilder reverseWord = new StringBuilder();

        for (int i = word.length() - 1; i >= 0; i--) {
            reverseWord.append(word.charAt(i));
        }

        reversedString.append(reverseWord).append(WHITESPACE);
    }

    return reversedString.toString();
}
```

Obtaining the same result in Java 8 functional style can be done as follows:

```
private static final Pattern PATTERN = Pattern.compile(" +");
...
```

```
public static String reverseWords(String str) {  
  
    return PATTERN.splitAsStream(str)  
        .map(w -> new StringBuilder(w).reverse())  
        .collect(Collectors.joining(" "));  
}
```

Notice that the preceding two methods return a string containing the letters of each word reversed, but the words themselves are in the same initial order. Now, let's consider another method that reverses the letters of each word and the words themselves. Thanks to the built-in `StringBuilder.reverse()` method, this is very easy to accomplish:

```
public String reverse(String str) {  
  
    return new StringBuilder(str).reverse().toString();  
}
```



For third-party library support, please consider the Apache Commons Lang, `StringUtils.reverse()`.

4. Checking whether a string contains only digits

The solution to this problem relies on the `Character.isDigit()` or `String.matches()` method.

The solution relying on `Character.isDigit()` is pretty simple and fast—loop the string characters and break the loop if this method returns `false`:

```
public static boolean containsOnlyDigits(String str) {  
  
    for (int i = 0; i < str.length(); i++) {  
        if (!Character.isDigit(str.charAt(i))) {  
            return false;  
        }  
    }  
  
    return true;  
}
```

In Java 8 functional style, the preceding code can be rewritten using `anyMatch()`:

```
public static boolean containsOnlyDigits(String str) {  
    return !str.chars()  
        .anyMatch(n -> !Character.isDigit(n));  
}
```

Another solution relies on `String.matches()`. This method returns a `boolean` value indicating whether or not this string matches the given regular expression:

```
public static boolean containsOnlyDigits(String str) {  
    return str.matches("[0-9]+");  
}
```

Notice that Java 8 functional style and regular expression-based solutions are usually slow, so if speed is a requirement, then it's better to rely on the first solution using `Character.isDigit()`.



Avoid solving this problem via `parseInt()` or `parseLong()`. First of all, it's bad practice to catch `NumberFormatException` and take business logic decisions in the `catch` block. Second, these methods verify whether the string is a valid number, not whether it contains only digits (for example, `-4` is valid).

For third-party library support, please consider the Apache Commons Lang, `StringUtils.isNumeric()`.

5. Counting vowels and consonants

The following code is for English, but depending on how many languages you are covering, the number of vowels and consonants may differ and the code should be adjusted accordingly.

The first solution to this problem requires traversing the string characters and doing the following:

1. We need to check whether the current character is a vowel (this is convenient since we only have five pure vowels in English; other languages have more vowels, but the number is still small).
2. If the current character is not a vowel, then check whether it sits between 'a' and 'z' (this means that the current character is a consonant).

Notice that, initially, the given `String` object is transformed into lowercase. This is useful to avoid comparisons with uppercase characters. For example, the comparison is accomplished only against `'a'` instead of `'A'` and `'a'`.

The code for this solution is as follows:

```
private static final Set<Character> allVowels
    = new HashSet(Arrays.asList('a', 'e', 'i', 'o', 'u'));

public static Pair<Integer, Integer>
    countVowelsAndConsonants(String str) {

    str = str.toLowerCase();
    int vowels = 0;
    int consonants = 0;

    for (int i = 0; i < str.length(); i++) {
        char ch = str.charAt(i);
        if (allVowels.contains(ch)) {
            vowels++;
        } else if ((ch >= 'a' && ch <= 'z')) {
            consonants++;
        }
    }

    return Pair.of(vowels, consonants);
}
```

In Java 8 functional style, this code can be rewritten using `chars()` and `filter()`:

```
private static final Set<Character> allVowels
    = new HashSet(Arrays.asList('a', 'e', 'i', 'o', 'u'));

public static Pair<Long, Long> countVowelsAndConsonants(String str) {

    str = str.toLowerCase();

    long vowels = str.chars()
        .filter(c -> allVowels.contains((char) c))
        .count();

    long consonants = str.chars()
        .filter(c -> !allVowels.contains((char) c))
        .filter(ch -> (ch >= 'a' && ch <= 'z'))
        .count();

    return Pair.of(vowels, consonants);
}
```

The given string is filtered accordingly and the `count()` terminal operation returns the result. Relying on `partitioningBy()` will reduce the code, as follows:

```
Map<Boolean, Long> result = str.chars()
    .mapToObj(c -> (char) c)
    .filter(ch -> (ch >= 'a' && ch <= 'z'))
    .collect(partitioningBy(c -> allVowels.contains(c), counting()));

return Pair.of(result.get(true), result.get(false));
```

Done! Now, let's see how we can count occurrences of a certain character in a string.

6. Counting the occurrences of a certain character

A simple solution to this problem consists of the following two steps:

1. Replace every occurrence of the character in the given string with "" (basically, this is like removing all of the occurrences of this character in the given string).
2. Subtract the length of the string that was obtained in the first step from the length of the initial string.

The code for this method is as follows:

```
public static int countOccurrencesOfACertainCharacter(
    String str, char ch) {

    return str.length() - str.replace(String.valueOf(ch), "").length();
}
```

The following solution covers Unicode surrogate pairs as well:

```
public static int countOccurrencesOfACertainCharacter(
    String str, String ch) {

    if (ch.codePointCount(0, ch.length()) > 1) {
        // there is more than 1 Unicode character in the given String
        return -1;
    }

    int result = str.length() - str.replace(ch, "").length();

    // if ch.length() return 2 then this is a Unicode surrogate pair
```

```
    return ch.length() == 2 ? result / 2 : result;
}
```

Another easy to implement and fast solution consists of looping the string characters (a single traversal) and comparing each character with the given character. Increase the counter by one for every match:

```
public static int countOccurrencesOfACertainCharacter(
    String str, char ch) {

    int count = 0;

    for (int i = 0; i < str.length(); i++) {
        if (str.charAt(i) == ch) {
            count++;
        }
    }

    return count;
}
```

The solution that covers the Unicode surrogate pairs is in the code that's bundled with this book. In Java 8 functional style, one solution consists of using `filter()` or `reduce()`. For example, using `filter()` will result in the following code:

```
public static long countOccurrencesOfACertainCharacter(
    String str, char ch) {

    return str.chars()
        .filter(c -> c == ch)
        .count();
}
```

The solution that covers the Unicode surrogate pairs is in the code that's bundled with this book.



For third-party library support, please consider Apache Commons Lang, `StringUtils.countMatches()`, Spring Framework, `StringUtils.countOccurrencesOf()`, and Guava, `CharMatcher.is().countIn()`.

7. Converting a string into an int, long, float, or double

Let's consider the following strings (negatives can be used as well):

```
private static final String TO_INT = "453";
private static final String TO_LONG = "45234223233";
private static final String TO_FLOAT = "45.823F";
private static final String TO_DOUBLE = "13.83423D";
```

A proper solution for converting `String` into `int`, `long`, `float`, or `double` consists of using the following Java methods of the `Integer`, `Long`, `Float`, and `Double` classes—`parseInt()`, `parseLong()`, `parseFloat()`, and `parseDouble()`:

```
int toInt = Integer.parseInt(TO_INT);
long toLong = Long.parseLong(TO_LONG);
float toFloat = Float.parseFloat(TO_FLOAT);
double toDouble = Double.parseDouble(TO_DOUBLE);
```

Converting `String` into an `Integer`, `Long`, `Float`, or `Double` object can be accomplished via the following Java methods—`Integer.valueOf()`, `Long.valueOf()`, `Float.valueOf()`, and `Double.valueOf()`:

```
Integer toInt = Integer.valueOf(TO_INT);
Long toLong = Long.valueOf(TO_LONG);
Float toFloat = Float.valueOf(TO_FLOAT);
Double toDouble = Double.valueOf(TO_DOUBLE);
```

When a `String` cannot be converted successfully, Java throws a `NumberFormatException` exception. The following code speaks for itself:

```
private static final String WRONG_NUMBER = "452w";

try {
    Integer toIntWrong1 = Integer.valueOf(WRONG_NUMBER);
} catch (NumberFormatException e) {
    System.err.println(e);
    // handle exception
}

try {
    int toIntWrong2 = Integer.parseInt(WRONG_NUMBER);
} catch (NumberFormatException e) {
    System.err.println(e);
    // handle exception
}
```



For third-party library support, please consider Apache Commons BeanUtils: `IntegerConverter`, `LongConverter`, `FloatConverter`, and `DoubleConverter`.

8. Removing white spaces from a string

The solution to this problem consists of using the `String.replaceAll()` method with the `\s` regular expression. Mainly, `\s` removes all white spaces, including the non-visible ones, such as `\t`, `\n`, and `\r`:

```
public static String removeWhitespaces(String str) {
    return str.replaceAll("\s", "");
}
```



Starting with JDK 11, `String.isBlank()` checks whether the string is empty or contains only white space code points. For third-party library support, please consider Apache Commons Lang, `StringUtils.deleteWhitespace()`, and the Spring Framework, `StringUtils.trimAllWhitespace()`.

9. Joining multiple strings with a delimiter

There are several solutions that fit well and solve this problem. Before Java 8, a convenient approach relied on `StringBuilder`, as follows:

```
public static String joinByDelimiter(char delimiter, String...args) {

    StringBuilder result = new StringBuilder();

    int i = 0;
    for (i = 0; i < args.length - 1; i++) {
        result.append(args[i]).append(delimiter);
    }
    result.append(args[i]);

    return result.toString();
}
```

Starting with Java 8, there are at least three more solutions to this problem. One of these solutions relies on the `StringJoiner` utility class. This class can be used to construct a sequence of characters separated by a delimiter (for example, a comma).

It supports an optional prefix and suffix as well (ignored here):

```
public static String joinByDelimiter(char delimiter, String...args) {
    StringJoiner joiner = new StringJoiner(String.valueOf(delimiter));

    for (String arg: args) {
        joiner.add(arg);
    }

    return joiner.toString();
}
```

Another solution relies on the `String.join()` method. This method was introduced in Java 8 and comes in two flavors:

```
String join(CharSequence delimiter, CharSequence... elems)
String join(CharSequence delimiter,
    Iterable<? extends CharSequence> elems)
```

An example of joining several strings delimited by a space is as follows:

```
String result = String.join(" ", "how", "are", "you"); // how are you
```

Going further, Java 8 streams and `Collectors.joining()` can be useful as well:

```
public static String joinByDelimiter(char delimiter, String...args) {
    return Arrays.stream(args, 0, args.length)
        .collect(Collectors.joining(String.valueOf(delimiter)));
}
```

Pay attention to concatenating strings via the `+=` operator, and the `concat()` and `String.format()` methods. These can be used to join several strings, but they are prone to performance penalties. For example, the following code relies on `+=` and is much slower than relying on `StringBuilder`:



```
String str = "";
for(int i = 0; i < 1_000_000; i++) {
    str += "x";
}
```

`+=` is appended to a string and reconstructs a new string, and that costs time.

For third-party library support, please consider Apache Commons Lang, `StringUtils.join()`, and Guava, `Joiner`.

10. Generating all permutations

Problems that involve permutations commonly involve *recursivity* as well. Basically, recursivity is defined as a process where some initial state is given and each *successive state* is defined in terms of the *preceding state*.

In our case, the state can be materialized by the letters of the given string. The initial state contains the initial string and each successive state can be computed by the following formula—each letter of the string will become the first letter of the string (swap positions) and then permute all of the remaining letters using a recursive call. While non-recursive or other recursive solutions exist, this is a classical solution to this problem.

Representing this solution for a string, ABC, can be done like so (notice how permutations are done):

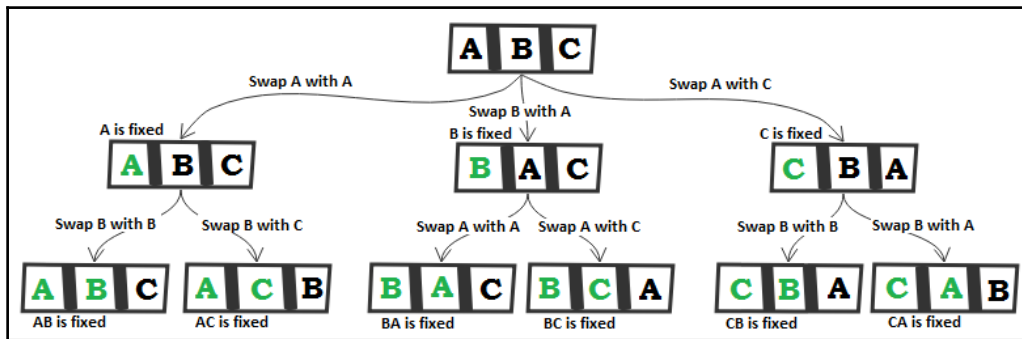

Coding this algorithm will result in something like the following:

```
public static void permuteAndPrint (String str) {
    permuteAndPrint("", str);
}

private static void permuteAndPrint (String prefix, String str) {

    int n = str.length();

    if (n == 0) {
        System.out.print (prefix + " ");
    } else {
        for (int i = 0; i < n; i++) {
            permuteAndPrint (prefix + str.charAt (i),
                str.substring (i + 1, n) + str.substring (0, i));
        }
    }
}
```

```
    }  
  }  
}
```

Initially, the prefix should be an empty string, "". At each iteration, the prefix will concatenate (fix) the next letter from the string. The remaining letters are passed through the method again.

Let's suppose that this method lives in a utility class named `Strings`. You can call it like so:

```
Strings.permuteAndStore("ABC");
```

This will produce the following output:

```
ABC ACB BCA BAC CAB CBA
```

Notice that this solution prints the result on the screen. Storing the result implies adding `Set` to the implementation. It is preferable to use `Set` since it eliminates duplicates:

```
public static Set<String> permuteAndStore(String str) {  
    return permuteAndStore("", str);  
}  
  
private static Set<String>  
    permuteAndStore(String prefix, String str) {  
  
    Set<String> permutations = new HashSet<>();  
    int n = str.length();  
  
    if (n == 0) {  
        permutations.add(prefix);  
    } else {  
        for (int i = 0; i < n; i++) {  
            permutations.addAll(permuteAndStore(prefix + str.charAt(i),  
                str.substring(i + 1, n) + str.substring(0, i)));  
        }  
    }  
  
    return permutations;  
}
```

For example, if the passed string is `TEST`, then `Set` will cause the following output (these are all unique permutations):

```
ETST SETT TEST TTSE STTE STET TETS TSTE TSET TTES ESTT ETTS
```

Using `List` instead of `Set` will result in the following output (notice the duplicates):

```
TEST TETS TSTE TSET TTES TTSE ESTT ESTT ETTS ETST ETST ETTS STTE STET
STET STTE SETT SETT TTES TTSE TEST TETS TSTE TSET
```

There are 24 permutations. It is easy to determine the number of resulted permutations by computing the n factorial ($n!$). For $n=4$ (length of the string), $4! = 1 \times 2 \times 3 \times 4 = 24$. When expressed in recursive style, this is $n! = n \times (n-1)!$.



Since $n!$ results in high numbers extremely fast (example, $10! = 3628800$), it is advisable to avoid storing the results. For a 10-character string such as `HELICOPTER`, there are 3,628,800 permutations!

Trying to implement this solution in Java 8 functional style will result in something like the following:

```
private static void permuteAndPrintStream(String prefix, String str) {
    int n = str.length();

    if (n == 0) {
        System.out.print(prefix + " ");
    } else {
        IntStream.range(0, n)
            .parallel()
            .forEach(i -> permuteAndPrintStream(prefix + str.charAt(i),
                str.substring(i + 1, n) + str.substring(0, i)));
    }
}
```

As a bonus, a solution that returns `Stream<String>` is available in the code bundled with this book.

11. Checking whether a string is a palindrome

Just as a quick reminder, a *palindrome* (whether a string or a number) looks unchanged when it's reversed. This means that processing (reading) a palindrome can be done from both directions and the same result will be obtained (for example, the word *madam* is a palindrome, while the word *madame* is not).

An easy to implement solution consists of comparing the letters of the given string in a *meet-in-the-middle* approach. Basically, this solution compares the first character with the last one, the second character with the last by one, and so on until the middle of the string is reached. The implementation relies on the `while` statement:

```
public static boolean isPalindrome(String str) {  
  
    int left = 0;  
    int right = str.length() - 1;  
  
    while (right > left) {  
        if (str.charAt(left) != str.charAt(right)) {  
            return false;  
        }  
  
        left++;  
        right--;  
    }  
    return true;  
}
```

Rewriting the preceding solution in a more concise approach will consist of relying on a `for` statement instead of a `while` statement, as follows:

```
public static boolean isPalindrome(String str) {  
  
    int n = str.length();  
  
    for (int i = 0; i < n / 2; i++) {  
        if (str.charAt(i) != str.charAt(n - i - 1)) {  
            return false;  
        }  
    }  
    return true;  
}
```

But can this solution be reduced to a single line of code? The answer is yes.

The Java API provides the `StringBuilder` class, which uses the `reverse()` method. As its name suggests, the `reverse()` method returns the reverse given string. In the case of a palindrome, the given string should be equal to the reverse version of it:

```
public static boolean isPalindrome(String str) {  
  
    return str.equals(new StringBuilder(str).reverse().toString());  
}
```

In Java 8 functional style, there is a single line of code for this as well. Simply define `IntStream` ranging from 0 to half of the given string and use the `noneMatch()` *short-circuiting* terminal operation with a predicate that compares the letters by following the *meet-in-the-middle* approach:

```
public static boolean isPalindrome(String str) {  
    return IntStream.range(0, str.length() / 2)  
        .noneMatch(p -> str.charAt(p) !=  
            str.charAt(str.length() - p - 1));  
}
```

Now, let's talk about removing duplicate characters from the given string.

12. Removing duplicate characters

Let's start with a solution to this problem that relies on `StringBuilder`. Mainly, the solution should loop the characters of the given string and construct a new string containing unique characters (it is not possible to simply remove characters from the given string since, in Java, a string is immutable).

The `StringBuilder` class exposes a method named `indexOf()`, which returns the index within the given string of the first occurrence of the specified substring (in our case, the specified character). So, a potential solution to this problem would be to loop the characters of the given string and add them one by one in `StringBuilder` every time the `indexOf()` method that's applied to the current character returns `-1` (this negative means that `StringBuilder` doesn't contain the current character):

```
public static String removeDuplicates(String str) {  
    char[] chArray = str.toCharArray(); // or, use charAt(i)  
    StringBuilder sb = new StringBuilder();  
  
    for (char ch : chArray) {  
        if (sb.indexOf(String.valueOf(ch)) == -1) {  
            sb.append(ch);  
        }  
    }  
    return sb.toString();  
}
```

The next solution relies on a collaboration between `HashSet` and `StringBuilder`. Mainly, `HashSet` ensures that duplicates are eliminated, while `StringBuilder` stores the resulting string. If `HashSet.add()` returns `true`, then we add the character in `StringBuilder` as well:

```
public static String removeDuplicates(String str) {  
  
    char[] chArray = str.toCharArray();  
    StringBuilder sb = new StringBuilder();  
    Set<Character> chHashSet = new HashSet<>();  
  
    for (char c: chArray) {  
        if (chHashSet.add(c)) {  
            sb.append(c);  
        }  
    }  
    return sb.toString();  
}
```

The solutions we've presented so far use the `toCharArray()` method to convert the given string into `char[]`. Alternatively, both solutions can use `str.charAt(position)` as well.

The third solution relies on Java 8 functional style:

```
public static String removeDuplicates(String str) {  
  
    return Arrays.asList(str.split("")).stream()  
        .distinct()  
        .collect(Collectors.joining());  
}
```

First, the solution converts the given string into `Stream<String>`, where each entry is actually a single character. Furthermore, the solution applies the stateful intermediate operation, `distinct()`. This operation will eliminate duplicates from the stream, so it returns a stream without duplicates. Finally, the solution calls the `collect()` terminal operation and relies on `Collectors.joining()`, which simply concatenates the characters into a string in the encounter order.

13. Removing a given character

A solution that relies on JDK support can exploit the `String.replaceAll()` method. This method replaces each substring (in our case, each character) of the given string that matches the given regular expression (in our case, the regular expression is the character itself) with the given replacement (in our case, the replacement is an empty string, `""`):

```
public static String removeCharacter(String str, char ch) {  
    return str.replaceAll(Pattern.quote(String.valueOf(ch)), "");  
}
```

Notice that the regular expression is wrapped in the `Pattern.quote()` method. This is needed to escape special characters such as `<`, `(`, `[`, `{`, `\`, `^`, `-`, `=`, `$`, `!`, `|`, `]`, `}`, `)`, `?`, `*`, `+`, `.`, and `>`. Mainly, this method returns a literal pattern string for the specified string.

Now, let's take a look at a solution that avoids regular expressions. This time, the solution relies on `StringBuilder`. Basically, the solution loops the characters of the given string and compares each character with the character to remove. Each time the current character is different from the character to remove, the current character is appended in `StringBuilder`:

```
public static String removeCharacter(String str, char ch) {  
    StringBuilder sb = new StringBuilder();  
    char[] chArray = str.toCharArray();  
  
    for (char c : chArray) {  
        if (c != ch) {  
            sb.append(c);  
        }  
    }  
  
    return sb.toString();  
}
```

Finally, let's focus on a Java 8 functional style approach. This is a four-step approach:

1. Convert the string into `IntStream` via the `String.chars()` method
2. Filter `IntStream` to eliminate duplicates
3. Map the resulted `IntStream` to `Stream<String>`
4. Join the strings from this stream and collect them as a single string

The code for this solution can be written as follows:

```
public static String removeCharacter(String str, char ch) {  
  
    return str.chars()  
        .filter(c -> c != ch)  
        .mapToObj(c -> String.valueOf((char) c))  
        .collect(Collectors.joining());  
}
```

Alternatively, if we want to remove a Unicode surrogate pair, then we can rely on `codePointAt()` and `codePoints()`, as shown in the following implementation:

```
public static String removeCharacter(String str, String ch) {  
  
    int codePoint = ch.codePointAt(0);  
  
    return str.codePoints()  
        .filter(c -> c != codePoint)  
        .mapToObj(c -> String.valueOf(Character.toChars(c)))  
        .collect(Collectors.joining());  
}
```



For third-party library support, please consider Apache Commons Lang, `StringUtils.remove()`.

Now, let's talk about how to find the character with the most appearances.

14. Finding the character with the most appearances

A pretty straightforward solution relies on `HashMap`. This solution consists of three steps:

1. First, loop the characters of the given string and put the pairs of the key-value in `HashMap` where the key is the current character and the value is the current number of occurrences
2. Second, compute the maximum value in `HashMap` (for example, using `Collections.max()`) representing the maximum number of occurrences
3. Finally, get the character that has the maximum number of occurrences by looping the `HashMap` entry set

The utility method returns `Pair<Character, Integer>` containing the character with the most appearances and the number of appearances (notice that the white spaces are ignored). If you don't prefer to have this extra class, that is, `Pair`, then just rely on `Map.Entry<K, V>`:

```
public static Pair<Character, Integer> maxOccurenceCharacter(
    String str) {

    Map<Character, Integer> counter = new HashMap<>();
    char[] chStr = str.toCharArray();

    for (int i = 0; i < chStr.length; i++) {
        char currentCh = chStr[i];
        if (!Character.isWhitespace(currentCh)) { // ignore spaces
            Integer noCh = counter.get(currentCh);
            if (noCh == null) {
                counter.put(currentCh, 1);
            } else {
                counter.put(currentCh, ++noCh);
            }
        }
    }

    int maxOccurrences = Collections.max(counter.values());
    char maxCharacter = Character.MIN_VALUE;

    for (Entry<Character, Integer> entry: counter.entrySet()) {
        if (entry.getValue() == maxOccurrences) {
            maxCharacter = entry.getKey();
        }
    }

    return Pair.of(maxCharacter, maxOccurrences);
}
```

If using `HashMap` looks cumbersome, then another solution (that's a little faster) consists of relying on the ASCII codes. This solution starts with an empty array of 256 indexes (256 is the maximum number of extended ASCII table codes; more information can be found in the *Finding the first non-repeated character* section). Furthermore, this solution loops the characters of the given string and keeps track of the number of appearances for each character by increasing the corresponding index in this array:

```
private static final int EXTENDED_ASCII_CODES = 256;
...
public static Pair<Character, Integer> maxOccurenceCharacter(
```

```
String str) {

    int maxOccurrences = -1;
    char maxCharacter = Character.MIN_VALUE;
    char[] chStr = str.toCharArray();
    int[] asciiCodes = new int[EXTENDED_ASCII_CODES];

    for (int i = 0; i < chStr.length; i++) {
        char currentCh = chStr[i];
        if (!Character.isWhitespace(currentCh)) { // ignoring space
            int code = (int) currentCh;
            asciiCodes[code]++;
            if (asciiCodes[code] > maxOccurrences) {
                maxOccurrences = asciiCodes[code];
                maxCharacter = currentCh;
            }
        }
    }

    return Pair.of(maxCharacter, maxOccurrences);
}
```

The last solution we will discuss here relies on Java 8 functional style:

```
public static Pair<Character, Long>
    maxOccurrenceCharacter(String str) {

    return str.chars()
        .filter(c -> Character.isWhitespace(c) == false) // ignoring space
        .mapToObj(c -> (char) c)
        .collect(groupingBy(c -> c, counting()))
        .entrySet()
        .stream()
        .max(comparingByValue())
        .map(p -> Pair.of(p.getKey(), p.getValue()))
        .orElse(Pair.of(Character.MIN_VALUE, -1L));
}
```

To start, this solution collects distinct characters as keys in `Map`, along with their number of occurrences as values. Furthermore, it uses the Java 8 `Map.Entry.comparingByValue()` and `max()` terminal operations to determine the entry in the map with the highest value (highest number of occurrences). Since `max()` is a terminal operation, the solution may return `Optional<Entry<Character, Long>>`, but this solution adds an extra step and maps this entry to `Pair<Character, Long>`.

15. Sorting an array of strings by length

The first thing that comes to mind when sorting is the use of a comparator.

In this case, the solution should compare lengths of strings, and so the integers are returned by calling `String.length()` for each string in the given array. So, if the integers are sorted (ascending or descending), then the strings will be sorted.

The Java `Arrays` class already provides a `sort()` method that takes the array to sort and a comparator. In this case, `Comparator<String>` should do the job.



Before Java 7, code that implemented a comparator relied on the `compareTo()` method. Common usage of this method was to compute a difference of the $x1-x2$ type, but this computation may lead to overflows. This makes `compareTo()` rather tedious. Starting with Java 7, `Integer.compare()` is the way to go (no overflow risks).

The following is a method that sorts the given array by relying on the `Arrays.sort()` method:

```
public static void sortByLength(String[] strs, Sort direction) {
    if (direction.equals(Sort.ASC)) {
        Arrays.sort(strs, (String s1, String s2)
            -> Integer.compare(s1.length(), s2.length()));
    } else {
        Arrays.sort(strs, (String s1, String s2)
            -> (-1) * Integer.compare(s1.length(), s2.length()));
    }
}
```



Each wrapper of a primitive numeric type has a `compare()` method.

Starting with Java 8, the `Comparator` interface was enriched with a significant number of useful methods. One of these methods is `comparingInt()`, which takes a function that extracts an `int` sort key from the generic type and returns a `Comparator<T>` value that compares it with that sort key. Another useful method is `reversed()`, which reverses the current `Comparator` value.

Based on these two methods, we can empower `Arrays.sort()` as follows:

```
public static void sortByLength(String[] strs, Sort direction) {
    if (direction.equals(Sort.ASC)) {
        Arrays.sort(strs, Comparator.comparingInt(String::length));
    } else {
        Arrays.sort(strs,
            Comparator.comparingInt(String::length).reversed());
    }
}
```



Comparators can be chained with the `thenComparing()` method.

The solutions we've presented here return `void`, which means that they sort the given array. To return a new sorted array and not alter the given array, we can use Java 8 functional style, as shown in the following snippet of code:

```
public static String[] sortByLength(String[] strs,
    Sort direction) {

    if (direction.equals(Sort.ASC)) {
        return Arrays.stream(strs)
            .sorted(Comparator.comparingInt(String::length))
            .toArray(String[]::new);
    } else {
        return Arrays.stream(strs)
            .sorted(Comparator.comparingInt(String::length).reversed())
            .toArray(String[]::new);
    }
}
```

So, the code creates a stream from the given array, sorts it via the `sorted()` stateful intermediate operation, and collects the result in another array.

16. Checking that a string contains a substring

A very simple, one line of code solution relies on the `String.contains()` method.

This method returns a `boolean` value indicating whether the given substring is present in the string or not:

```
String text = "hello world!";
String subtext = "orl";

// pay attention that this will return true for subtext=""
boolean contains = text.contains(subtext);
```

Alternatively, a solution can be implemented by relying on `String.indexOf()` (or `String.lastIndexOf()`), as follows:

```
public static boolean contains(String text, String subtext) {
    return text.indexOf(subtext) != -1; // or lastIndexOf()
}
```

Another solution can be implemented based on a regular expression, as follows:

```
public static boolean contains(String text, String subtext) {
    return text.matches("(?i).*" + Pattern.quote(subtext) + ".*");
}
```

Notice that the regular expression is wrapped in the `Pattern.quote()` method. This is needed to escape special characters such as `<([\^-=#!|])?*>` in the given substring.



For third-party library support, please consider Apache Commons Lang, `StringUtils.containsIgnoreCase()`.

17. Counting substring occurrences in a string

Counting the number of occurrences of a string in another string is a problem that can have at least two interpretations:

- 11 in 111 occurs 1 time
- 11 in 111 occurs 2 times

In the first case (11 in 111 occurs 1 time), the solution can rely on the `String.indexOf()` method. One of the flavors of this method allows us to obtain the index within this string of the first occurrence of the specified substring, starting at the specified index (or -1, if there is no such occurrence). Based on this method, the solution can simply traverse the given string and count the given substring occurrences. The traversal starts from position 0 and continues until the substring is not found:

```
public static int countStringInString(String string, String toFind) {  
  
    int position = 0;  
    int count = 0;  
    int n = toFind.length();  
  
    while ((position = string.indexOf(toFind, position)) != -1) {  
        position = position + n;  
        count++;  
    }  
  
    return count;  
}
```

Alternatively, the solution can use the `String.split()` method. Basically, the solution can split the given string using the given substring as a delimiter. The length of the resulting `String[]` array should be equal to the number of expected occurrences:

```
public static int countStringInString(String string, String toFind) {  
  
    int result = string.split(Pattern.quote(toFind), -1).length - 1;  
  
    return result < 0 ? 0 : result;  
}
```

In the second case (11 in 111 occurs 2 times), the solution can rely on the `Pattern` and `Matcher` classes in a simple implementation, as follows:

```
public static int countStringInString(String string, String toFind) {  
  
    Pattern pattern = Pattern.compile(Pattern.quote(toFind));  
    Matcher matcher = pattern.matcher(string);  
  
    int position = 0;  
    int count = 0;  
  
    while (matcher.find(position)) {
```

```
        position = matcher.start() + 1;
        count++;
    }

    return count;
}
```

Nice! Let's continue with another problem with strings.

18. Checking whether two strings are anagrams

Two strings that have the same characters, but that are in a different order, are anagrams. Some definitions impose that anagrams are case-insensitive and/or that white spaces (blanks) should be ignored.

So, independent of the applied algorithm, the solution must convert the given string into lowercase and remove white spaces (blanks). Besides that, the first solution we mentioned sorts the arrays via `Arrays.sort()` and will check their equality via `Arrays.equals()`.

Once they are sorted, if they are anagrams, they will be equal (the following diagram shows two words that are anagrams):

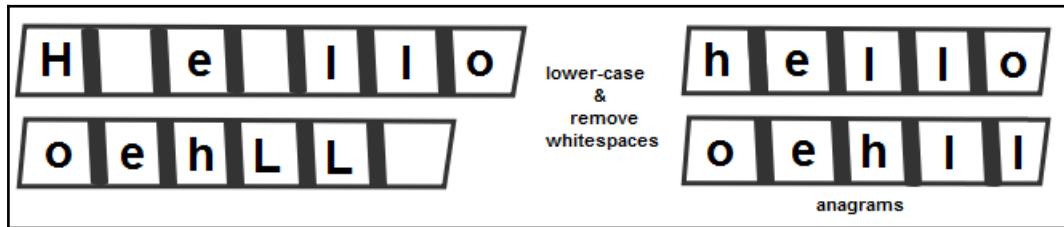

This solution (including its Java 8 functional style version) is available in the code bundled with this book. The main drawback of these two solutions is represented by the sorting part. The following solution eliminates this step and relies on an empty array (initially containing only 0) of 256 indexes (extended ASCII table codes of characters—more information can be found in the *Finding the first non-repeated character* section).

The algorithm is pretty simple:

- For each character from the first string, this solution increases the value in this array corresponding to the ASCII code by 1
- For each character from the second string, this solution decreases the value in this array corresponding to the ASCII code by 1

The code is as follows:

```
private static final int EXTENDED_ASCII_CODES = 256;
...
public static boolean isAnagram(String str1, String str2) {

    int[] chCounts = new int[EXTENDED_ASCII_CODES];
    char[] chStr1 = str1.replaceAll("\\s",
        "").toLowerCase().toCharArray();
    char[] chStr2 = str2.replaceAll("\\s",
        "").toLowerCase().toCharArray();

    if (chStr1.length != chStr2.length) {
        return false;
    }

    for (int i = 0; i < chStr1.length; i++) {
        chCounts[chStr1[i]]++;
        chCounts[chStr2[i]]--;
    }

    for (int i = 0; i < chCounts.length; i++) {
        if (chCounts[i] != 0) {
            return false;
        }
    }

    return true;
}
```

At the end of this traversal, if the given strings are anagrams, then this array contains only 0.

19. Declaring multiline strings (text blocks)

At the time of writing this book, JDK 12 had a proposal for adding multiline strings known as *JEP 326: Raw String Literals*. But this was dropped at the last minute.

Starting with JDK 13, the idea was reconsidered and, unlike the declined raw string literals, text blocks are surrounded by three double quotes, `"""`, as follows:

```
String text = """My high school,
the Illinois Mathematics and Science Academy,
showed me that anything is possible
and that you're never too young to think big.""";
```



Text blocks can be very useful for writing multiline SQL statements, using polyglot languages, and so on. More details can be found at <https://openjdk.java.net/jeps/355>.

Nevertheless, there are several surrogate solutions that can be used before JDK 13. These solutions have a common point—the use of the line separator:

```
private static final String LS = System.lineSeparator();
```

Starting with JDK 8, a solution may rely on `String.join()`, as follows:

```
String text = String.join(LS,
    "My high school, ",
    "the Illinois Mathematics and Science Academy,",
    "showed me that anything is possible ",
    "and that you're never too young to think big.");
```

Before JDK 8, an elegant solution may have relied on `StringBuilder`. This solution is available in the code bundled with this book.

While the preceding solutions are good fits for a relatively large number of strings, the following two are okay if we just have a few strings. The first one uses the `+` operator:

```
String text = "My high school, " + LS +
    "the Illinois Mathematics and Science Academy," + LS +
    "showed me that anything is possible " + LS +
    "and that you're never too young to think big.";
```

The second one uses `String.format()`:

```
String text = String.format("%s" + LS + "%s" + LS + "%s" + LS + "%s",
    "My high school, ",
    "the Illinois Mathematics and Science Academy,",
    "showed me that anything is possible ",
    "and that you're never too young to think big.");
```



How can we process each line of a multiline string? Well, a quick approach requires JDK 11, which comes with the `String.lines()` method. This method splits the given string via a line separator (which supports `\n`, `\r`, and `\r\n`) and transforms it into `Stream<String>`. Alternatively, the `String.split()` method can be used as well (this is available starting with JDK 1.4). If the number of strings becomes significant, it is advised to put them in a file and read/process them one by one (for example, via the `getResourceAsStream()` method). Other approaches rely on `StringWriter` or `BufferedWriter.newLine()`.

For third-party library support, please consider Apache Commons Lang, `StringUtils.join()`, Guava, `Joiner`, and the custom annotation, `@Multiline`.

20. Concatenating the same string n times

Before JDK 11, a solution could be quickly provided via `StringBuilder`, as follows:

```
public static String concatRepeat(String str, int n) {  
    StringBuilder sb = new StringBuilder(str.length() * n);  
  
    for (int i = 1; i <= n; i++) {  
        sb.append(str);  
    }  
  
    return sb.toString();  
}
```

Starting with JDK 11, the solution relies on the `String.repeat(int count)` method. This method returns a string resulting from concatenating this string `count` times. Behind the scenes, this method uses `System.arraycopy()`, which makes this very fast:

```
String result = "hello".repeat(5);
```

Other solutions that can fit well in different scenarios are listed as follows:

- Following is a `String.join()`-based solution:

```
String result = String.join("", Collections.nCopies(5, TEXT));
```

- Following is a `Stream.generate()`-based solution:

```
String result = Stream.generate(() -> TEXT)
    .limit(5)
    .collect(joining());
```

- Following is a `String.format()`-based solution:

```
String result = String.format("%0" + 5 + "d", 0)
    .replace("0", TEXT);
```

- Following is a `char[]` based solution:

```
String result = new String(new char[5]).replace("\0", TEXT);
```



For third-party library support, please consider [Apache Commons Lang](#), `StringUtils.repeat()`, and [Guava](#), `Strings.repeat()`.

To check whether a string is a sequence of the same substring, rely on the following method:

```
public static boolean hasOnlySubstrings(String str) {
    StringBuilder sb = new StringBuilder();
    for (int i = 0; i < str.length() / 2; i++) {
        sb.append(str.charAt(i));
        String resultStr = str.replaceAll(sb.toString(), "");
        if (resultStr.length() == 0) {
            return true;
        }
    }
    return false;
}
```

The solution loops half of the given string and progressively replaces it with "", a substring build, by appending the original string in `StringBuilder`, character by character. If these replacements result in an empty string, it means that the given string is a sequence of the same substring.

21. Removing leading and trailing spaces

The quickest solution to this problem probably relies on the `String.trim()` method. This method is capable of removing all leading and trailing spaces, that is, any character whose code point is less than or equal to U+0020 or 32 (the space character):

```
String text = "\n \n\n hello \t \n \r";
String trimmed = text.trim();
```

The preceding snippet of code will work as expected. The trimmed string will be `hello`. This only works because all of the white spaces that are being used are less than U+0020 or 32 (the space character). There are 25 characters (https://en.wikipedia.org/wiki/Whitespace_character#Unicode) defined as white spaces and `trim()` covers only a part of them (in short, `trim()` is not Unicode aware). Let's consider the following string:

```
char space = '\u2002';
String text = space + "\n \n\n hello \t \n \r" + space;
```

`\u2002` is another type of white space that `trim()` doesn't recognize (`\u2002` is above `\u0020`). This means that, in such cases, `trim()` will not work as expected. Starting with JDK 11, this problem has a solution named `strip()`. This method extends the power of `trim()` into the land of Unicode:

```
String stripped = text.strip();
```

This time, all of the leading and trailing white spaces are removed.



Moreover, JDK 11 comes with two flavors of `strip()` for removing only the leading (`stripLeading()`) or only the trailing (`stripTrailing()`) white spaces. The `trim()` method doesn't have these flavors.

22. Finding the longest common prefix

Let's consider the following array of strings:

```
String[] texts = {"abc", "abcd", "abcde", "ab", "abcd", "abcdef"};
```

Now, let's put these strings one below the other, as follows:

```
abc
abcd
abcde
```

```
ab
abcd
abcdef
```

A simple comparison of these strings reveals that `ab` is the longest common prefix. Now, let's dive into a solution for solving this problem. The solution that we've presented here relies on a straightforward comparison. This solution takes the first string from the array and compares each of its characters in the rest of the strings. The algorithm stops if either of the following happens:

- The length of the first string is greater than the length of any of the other strings
- The current character of the first string is not the same as the current character of any of the other strings

If the algorithm forcibly stops because of one of the preceding scenarios, then the longest common prefix is the substring from 0 to the index of the current character from the first string. Otherwise, the longest common prefix is the first string from the array. The code for this solution is as follows:

```
public static String longestCommonPrefix(String[] strs) {
    if (strs.length == 1) {
        return strs[0];
    }

    int firstLen = strs[0].length();

    for (int prefixLen = 0; prefixLen < firstLen; prefixLen++) {
        char ch = strs[0].charAt(prefixLen);
        for (int i = 1; i < strs.length; i++) {
            if (prefixLen >= strs[i].length()
                || strs[i].charAt(prefixLen) != ch) {
                return strs[i].substring(0, prefixLen);
            }
        }
    }

    return strs[0];
}
```

Other solutions to this problem use well-known algorithms such as **Binary Search** or **Trie**. In the source code that accompanies this book, there is a solution based on Binary Search as well.

23. Applying indentation

Starting with JDK 12, we can indent text via the `String.indent(int n)` method.

Let's assume that we have the following `String` values:

```
String days = "Sunday\n"
+ "Monday\n"
+ "Tuesday\n"
+ "Wednesday\n"
+ "Thursday\n"
+ "Friday\n"
+ "Saturday";
```

Printing this `String` values with an indentation of 10 spaces can be done as follows:

```
System.out.print(days.indent(10));
```

The output will be as follows:

```
Sunday
Monday
Tuesday
Wednesday
Thursday
Friday
Saturday
```

Now, let's try a cascade indentation:

```
List<String> days = Arrays.asList("Sunday", "Monday", "Tuesday",
    "Wednesday", "Thursday", "Friday", "Saturday");

for (int i = 0; i < days.size(); i++) {
    System.out.print(days.get(i).indent(i));
}
```

The output will be as follows:

```
Sunday
Monday
Tuesday
Wednesday
Thursday
Friday
Saturday
```

Now, let's indent depending on the length of the `String` value:

```
days.stream()
    .forEachOrdered(d -> System.out.print(d.indent(d.length())));
```

The output will be as follows:

```
    Sunday
    Monday
    Tuesday
    Wednesday
    Thursday
    Friday
    Saturday
```

How about indenting a piece of HTML code? Let's see:

```
String html = "<html>";
String body = "<body>";
String h2 = "<h2>";
String text = "Hello world!";
String closeH2 = "</h2>";
String closeBody = "</body>";
String closeHtml = "</html>";

System.out.println(html.indent(0) + body.indent(4) + h2.indent(8)
    + text.indent(12) + closeH2.indent(8) + closeBody.indent(4)
    + closeHtml.indent(0));
```

The output will be as follows:

```
<html>
  <body>
    <h2>
      Hello world!
    </h2>
  </body>
</html>
```

24. Transforming strings

Let's assume that we have a string and we want to transform it into another string (for example, transform it into upper case). We can do this by applying a function such as `Function<? super String, ? extends R>`.

In JDK 8, we can accomplish this via `map()`, as shown in the following two simple examples:

```
// hello world
String resultMap = Stream.of("hello")
    .map(s -> s + " world")
    .findFirst()
    .get();

// G000000000000000000L! G000000000000000000L!
String resultMap = Stream.of("gool! ")
    .map(String::toUpperCase)
    .map(s -> s.repeat(2))
    .map(s -> s.replaceAll("O", "0000"))
    .findFirst()
    .get();
```

Starting with JDK 12, we can rely on a new method named `transform(Function<? super String, ? extends R> f)`. Let's rewrite the preceding snippets of code via `transform()`:

```
// hello world
String result = "hello".transform(s -> s + " world");

// G000000000000000000L! G000000000000000000L!
String result = "gool! ".transform(String::toUpperCase)
    .transform(s -> s.repeat(2))
    .transform(s -> s.replaceAll("O", "0000"));
```

While `map()` is more general, `transform()` is dedicated to applying a function to a string and returns the resulting string.

25. Computing the minimum and maximum of two numbers

Before JDK 8, a possible solution would be to rely on the `Math.min()` and `Math.max()` methods, as follows:

```
int i1 = -45;
int i2 = -15;
int min = Math.min(i1, i2);
int max = Math.max(i1, i2);
```

The `Math` class provides a `min()` and a `max()` method for each primitive numeric type (`int`, `long`, `float`, and `double`).

Starting with JDK 8, each wrapper class of primitive numeric types (`Integer`, `Long`, `Float`, and `Double`) comes with dedicated `min()` and `max()` methods, and, behind these methods, there are invocations of their correspondents from the `Math` class. See the following example (this is a little bit more expressive):

```
double d1 = 0.023844D;
double d2 = 0.35468856D;
double min = Double.min(d1, d2);
double max = Double.max(d1, d2);
```

In a functional style context, a potential solution will rely on the `BinaryOperator` functional interface. This interface comes with two methods, `minBy()` and `maxBy()`:

```
float f1 = 33.34F;
final float f2 = 33.213F;
float min = BinaryOperator.minBy(Float::compare).apply(f1, f2);
float max = BinaryOperator.maxBy(Float::compare).apply(f1, f2);
```

These two methods are capable of returning the minimum (respectively, the maximum) of two elements according to the specified comparator.

26. Summing two large int/long values and operation overflow

Let's dive into the solution by starting with the + operator, as in the following example:

```
int x = 2;
int y = 7;
int z = x + y; // 9
```

This is a very simple approach and works fine for most of the computations that involve `int`, `long`, `float`, and `double`.

Now, let's apply this operator on the following two large numbers (sum 2,147,483,647 with itself):

```
int x = Integer.MAX_VALUE;
int y = Integer.MAX_VALUE;
int z = x + y; // -2
```

This time, `z` will be equal to `-2`, which is not the expected result, that is, 4,294,967,294. Changing only the `z` type from `int` to `long` will not help. However, changing the types of `x` and `y` from `int` to `long` as well *will* help:

```
long x = Integer.MAX_VALUE;
long y = Integer.MAX_VALUE;
long z = x + y; // 4294967294
```

But the problem will reappear if, instead of `Integer.MAX_VALUE`, there is `Long.MAX_VALUE`:

```
long x = Long.MAX_VALUE;
long y = Long.MAX_VALUE;
long z = x + y; // -2
```

Starting with JDK 8, the + operator has been wrapped in a more expressive way by each wrapper of a primitive numeric type. Therefore, the `Integer`, `Long`, `Float`, and `Double` classes have a `sum()` method:

```
long z = Long.sum(); // -2
```

Behind the scenes, the `sum()` methods uses the `+` operator as well, so they simply produce the same result.

But also starting with JDK 8, the `Math` class was enriched with two `addExact()` methods. There is one `addExact()` for summing two `int` variables and one for summing two `long` variables. These methods are very useful if the result is prone to overflowing `int` or `long`, as shown in the preceding case. In such cases, these methods throw `ArithmeticException` instead of returning a misleading result, as in the following example:

```
int z = Math.addExact(x, y); // throw ArithmeticException
```

The code will throw an exception such as `java.lang.ArithmeticException: integer overflow`. This is useful since it allows us to avoid introducing misleading results in further computations (for example, earlier, `-2` could silently enter further computations).

In a functional style context, a potential solution will rely on the `BinaryOperator` functional interface, as follows (simply define the operation of the two operands of the same type):

```
BinaryOperator<Integer> operator = Math::addExact;  
int z = operator.apply(x, y);
```

Besides `addExact()`, `Math` has `multiplyExact()`, `subtractExact()`, and `negateExact()`. Moreover, the well-known increment and decrement expressions, `i++` and `i--`, can be controlled for overflowing their domains via the `incrementExact()` and `decrementExact()` methods (for example, `Math.incrementExact(i)`). Notice that these methods are only available for `int` and `long`.



When working with a large number, also focus on the `BigInteger` (immutable arbitrary-precision integers) and `BigDecimal` (immutable, arbitrary-precision signed decimal numbers) classes.

27. String as an unsigned number in the radix

The support for unsigned arithmetic was added to Java starting with version 8. The `Byte`, `Short`, `Integer`, and `Long` classes were affected the most by this addition.

In Java, strings representing positive numbers can be parsed as unsigned `int` and `long` types via the `parseUnsignedInt()` and `parseUnsignedLong()` JDK 8 methods. For example, let's consider the following integer as a string:

```
String nri = "255500";
```

The solution to parsing it into an unsigned `int` value in the radix of 36 (the maximum accepted radix) looks as follows:

```
int result = Integer.parseUnsignedInt(nri, Character.MAX_RADIX);
```

The first argument is the number, while the second is the radix. The radix should be in the range `[2, 36]` or `[Character.MIN_RADIX, Character.MAX_RADIX]`.

Using a radix of 10 can be easily accomplished as follows (this method applies a radix of 10 by default):

```
int result = Integer.parseUnsignedInt(nri);
```

Starting with JDK 9, `parseUnsignedInt()` has a new flavor. Besides the string and the radix, this method accepts a range of the `[beginIndex, endIndex]` type. This time, the parsing is accomplished in this range. For example, specifying the range `[1, 3]` can be done as follows:

```
int result = Integer.parseUnsignedInt(nri, 1, 4, Character.MAX_RADIX);
```

The `parseUnsignedInt()` method can parse strings that represent numbers greater than `Integer.MAX_VALUE` (trying to accomplish this via `Integer.parseInt()` will throw a `java.lang.NumberFormatException` exception):

```
// Integer.MAX_VALUE + 1 = 2147483647 + 1 = 2147483648
int maxValuePlus1 = Integer.parseUnsignedInt("2147483648");
```



The same set of methods exist for long numbers in the `Long` class (for example, `parseUnsignedLong()`).

28. Converting into a number by an unsigned conversion

The problem requires that we convert the given signed `int` into `long` via an unsigned conversion. So, let's consider signed `Integer.MIN_VALUE`, which is `-2,147,483,648`.

In JDK 8, by using the `Integer.toUnsignedLong()` method, the conversion will be as follows (the result will be 2,147,483,648):

```
long result = Integer.toUnsignedLong(Integer.MIN_VALUE);
```

Here is another example that converts the signed `Short.MIN_VALUE` and `Short.MAX_VALUE` into unsigned integers:

```
int result1 = Short.toUnsignedInt(Short.MIN_VALUE);
int result2 = Short.toUnsignedInt(Short.MAX_VALUE);
```

Other methods from the same category are `Integer.toUnsignedString()`, `Long.toUnsignedString()`, `Byte.toUnsignedInt()`, `Byte.toUnsignedLong()`, `Short.toUnsignedInt()`, and `Short.toUnsignedLong()`.

29. Comparing two unsigned numbers

Let's consider two signed integers, `Integer.MIN_VALUE` (-2,147,483,648) and `Integer.MAX_VALUE` (2,147,483,647). Comparing these integers (signed values) will result in -2,147,483,648 being smaller than 2,147,483,647:

```
// resultSigned is equal to -1 indicating that
// MIN_VALUE is smaller than MAX_VALUE
int resultSigned = Integer.compare(Integer.MIN_VALUE,
    Integer.MAX_VALUE);
```

In JDK 8, these two integers can be compared as unsigned values via the `Integer.compareUnsigned()` method (this is the equivalent of `Integer.compare()` for unsigned values). Mainly, this method ignores the notion of *sign bit*, and the *left-most bit* is considered the most significant bit. Under the unsigned values umbrella, this method returns 0 if the compared numbers are equal, a value less than 0 if the first unsigned value is smaller than the second, and a value greater than 0 if the first unsigned value is greater than the second.

The following comparison returns 1, indicating that the unsigned value of `Integer.MIN_VALUE` is greater than the unsigned value of `Integer.MAX_VALUE`:

```
// resultSigned is equal to 1 indicating that
// MIN_VALUE is greater than MAX_VALUE
int resultUnsigned
    = Integer.compareUnsigned(Integer.MIN_VALUE, Integer.MAX_VALUE);
```



The `compareUnsigned()` method is available in the `Integer` and `Long` classes starting with JDK 8, and in the `Byte` and `Short` classes starting with JDK 9.

30. Division and modulo of unsigned values

Computing the unsigned quotient and remainder that resulted from the division of two unsigned values is supported by the JDK 8 unsigned arithmetic API via the `divideUnsigned()` and `remainderUnsigned()` methods.

Let's consider the `Integer.MIN_VALUE` and `Integer.MAX_VALUE` signed numbers and let's apply division and modulo. There's nothing new here:

```
// signed division
// -1
int divisionSignedMinMax = Integer.MIN_VALUE / Integer.MAX_VALUE;

// 0
int divisionSignedMaxMin = Integer.MAX_VALUE / Integer.MIN_VALUE;

// signed modulo
// -1
int moduloSignedMinMax = Integer.MIN_VALUE % Integer.MAX_VALUE;

// 2147483647
int moduloSignedMaxMin = Integer.MAX_VALUE % Integer.MIN_VALUE;
```

Now, let's treat `Integer.MIN_VALUE` and `Integer.MAX_VALUE` as unsigned values and let's apply `divideUnsigned()` and `remainderUnsigned()`:

```
// division unsigned
int divisionUnsignedMinMax = Integer.divideUnsigned(
    Integer.MIN_VALUE, Integer.MAX_VALUE); // 1
int divisionUnsignedMaxMin = Integer.divideUnsigned(
    Integer.MAX_VALUE, Integer.MIN_VALUE); // 0

// modulo unsigned
int moduloUnsignedMinMax = Integer.remainderUnsigned(
    Integer.MIN_VALUE, Integer.MAX_VALUE); // 1
int moduloUnsignedMaxMin = Integer.remainderUnsigned(
    Integer.MAX_VALUE, Integer.MIN_VALUE); // 2147483647
```

Notice their similarity to the comparison operation. Both operations, that is, unsigned division and unsigned modulo, interpret all of the bits as *value bits* and ignore the *sign bit*.



`divideUnsigned()` and `remainderUnsigned()` are present in the `Integer` and `Long` classes, respectively.

31. double/float is a finite floating-point value

This problem arises from the fact that some floating-point methods and operations produce `Infinity` or `NaN` as results instead of throwing an exception.

The solution to checking whether the given `float/double` is a finite floating-point value relies on the following conditions—the absolute value of the given `float/double` value must not exceed the largest positive finite value of the `float/double` type:

```
// for float
Math.abs(f) <= Float.MAX_VALUE;

// for double
Math.abs(d) <= Double.MAX_VALUE
```

Starting with Java 8, the preceding conditions were exposed via two dedicated flag-methods, `Float.isFinite()` and `Double.isFinite()`. Therefore, the following examples are valid test cases for finite floating-point values:

```
Float f1 = 4.5f;
boolean f1f = Float.isFinite(f1); // f1 = 4.5, is finite

Float f2 = f1 / 0;
boolean f2f = Float.isFinite(f2); // f2 = Infinity, is not finite

Float f3 = 0f / 0f;
boolean f3f = Float.isFinite(f3); // f3 = NaN, is not finite

Double d1 = 0.000333411333d;
boolean d1f = Double.isFinite(d1); // d1 = 3.33411333E-4, is finite

Double d2 = d1 / 0;
boolean d2f = Double.isFinite(d2); // d2 = Infinity, is not finite
```

```
Double d3 = Double.POSITIVE_INFINITY * 0;
boolean d3f = Double.isFinite(d3); // d3 = NaN, is not finite
```

These methods are handy in conditions such as the following:

```
if (Float.isFinite(d1)) {
    // do a computation with d1 finite floating-point value
} else {
    // d1 cannot enter in further computations
}
```

32. Applying logical AND/OR/XOR to two boolean expressions

The truth table of elementary logic operations (AND, OR, and XOR) looks as follows:

X	Y	AND	OR	XOR
0	0	0	0	0
0	1	0	1	1
1	0	0	1	1
1	1	1	1	0

In Java, the logical **AND** operator is represented as `&&`, the logical **OR** operator is represented as `||`, and the logical **XOR** operator is represented as `^`. Starting with JDK 8, these operators are applied to two booleans and are wrapped in three static methods—`Boolean.logicalAnd()`, `Boolean.logicalOr()`, and `Boolean.logicalXor()`:

```
int s = 10;
int m = 21;

// if (s > m && m < 50) { } else { }
if (Boolean.logicalAnd(s > m, m < 50)) {} else {}

// if (s > m || m < 50) { } else { }
if (Boolean.logicalOr(s > m, m < 50)) {} else {}

// if (s > m ^ m < 50) { } else { }
if (Boolean.logicalXor(s > m, m < 50)) {} else {}
```

Using a combination of these methods is also possible:

```
if (Boolean.logicalAnd(
    Boolean.logicalOr(s > m, m < 50),
    Boolean.logicalOr(s <= m, m > 50))) {} else {}
```

33. Converting BigInteger into a primitive type

The `BigInteger` class is a very handy tool for representing immutable arbitrary-precision integers.

This class also contains methods (originating from `java.lang.Number`) that are useful for converting `BigInteger` into a primitive type such as `byte`, `long`, or `double`. However, these methods can produce unexpected results and confusion. For example, let's assume that we have `BigInteger` that wraps `Long.MAX_VALUE`:

```
BigInteger nr = BigInteger.valueOf(Long.MAX_VALUE);
```

Let's convert this `BigInteger` into a primitive `long` via the `BigInteger.longValue()` method:

```
long nrLong = nr.longValue();
```

So far, everything has worked as expected since the `Long.MAX_VALUE` is 9,223,372,036,854,775,807 and the `nrLong` primitive variable has exactly this value.

Now, let's try to convert this `BigInteger` class into a primitive `int` value via the `BigInteger.intValue()` method:

```
int nrInt = nr.intValue();
```

This time, the `nrInt` primitive variable will have a value of -1 (the same result will produce `shortValue()` and `byteValue()`). Conforming to the documentation, if the value of `BigInteger` is too big to fit in the specified primitive type, only the low-order n bits are returned (n depends on the specified primitive type). But if the code is not aware of this statement, then it will push values as -1 in further computations, which will lead to confusion.

However, starting with JDK 8, a new set of methods was added. These methods are dedicated to identifying the information that's lost during the conversion from `BigInteger` into the specified primitive type. If a piece of lost information is detected, `ArithmeticException` will be thrown. This way, the code signals that the conversion has encountered some issues and prevents this unpleasant situation.

These methods are `longValueExact()`, `intValueExact()`, `shortValueExact()`, and `byteValueExact()`:

```
long nrExactLong = nr.longValueExact(); // works as expected
int nrExactInt = nr.intValueExact();    // throws ArithmeticException
```

Notice that `intValueExact()` did not return `-1` as `intValue()`. This time, the lost information that was caused by the attempt of converting the largest `long` value into `int` was signaled via an exception of the `ArithmeticException` type.

34. Converting long into int

Converting a `long` value into an `int` value seems like an easy job. For example, a potential solution can rely on casting the following:

```
long nr = Integer.MAX_VALUE;
int intNrCast = (int) nr;
```

Alternatively, it can rely on `Long.intValue()`, as follows:

```
int intNrValue = Long.valueOf(nrLong).intValue();
```

Both approaches work just fine. Now, let's suppose we have the following `long` value:

```
long nrMaxLong = Long.MAX_VALUE;
```

This time, both approaches will return `-1`. In order to avoid such results, it is advisable to rely on JDK 8, that is, `Math.toIntExact()`. This method gets an argument of the `long` type and tries to convert it into `int`. If the obtained value overflows `int`, then this method will throw `ArithmeticException`:

```
// throws ArithmeticException
int intNrMaxExact = Math.toIntExact(nrMaxLong);
```

Behind the scenes, `toIntExact()` relies on the `((int) value != value)` condition.

35. Computing the floor of a division and modulus

Let's assume that we have the following division:

```
double z = (double)222/14;
```

This will initialize `z` with the result of this division, that is, 15.85, but our problem requests the floor of this division, which is 15 (this is the largest integer value that is less than or equal to the algebraic quotient). A solution to obtain this desired result will consist of applying `Math.floor(15.85)`, which is 15.

However, 222 and 14 are integers, and so this preceding division is written as follows:

```
int z = 222/14;
```

This time, `z` will be equal to 15, which is exactly the expected result (the `/` operator returns the integer closest to zero). There is no need to apply `Math.floor(z)`. Moreover, if the divisor is 0, then `222/0` will throw `ArithmeticException`.

The conclusion so far is that the floor of a division for two integers that have the same sign (both are positive or negative) can be obtained via the `/` operator.

Okay, so far, so good, but let's assume that we have the following two integers (opposite signs; the dividend is negative and the divisor is positive, and vice versa):

```
double z = (double) -222/14;
```

This time, `z` will be equal to -15.85. Again, by applying `Math.floor(z)`, the result will be -16, which is correct (this is the largest integer value that is less than or equal to the algebraic quotient).

Let's go over the same problem again with `int`:

```
int z = -222/14;
```

This time, `z` will be equal to -15. This is incorrect and `Math.floor(z)` will not help us in this case since `Math.floor(-15)` is -15. So, this is a problem that should be considered.

From JDK 8 onward, all of these cases have been covered and exposed via the `Math.floorDiv()` method. This method takes two integers representing the dividend and the divisor as arguments and returns the largest (closest to positive infinity) `int` value that is less than or equal to the algebraic quotient:

```
int x = -222;
int y = 14;

// x is the dividend, y is the divisor
int z = Math.floorDiv(x, y); // -16
```

The `Math.floorDiv()` method comes in three flavors: `floorDiv(int x, int y)`, `floorDiv(long x, int y)`, and `floorDiv(long x, long y)`.



After `Math.floorDiv()`, JDK 8 came with `Math.floorMod()`, which returns the floor modulus of the given arguments. This is computed as the result of `x - (floorDiv(x, y) * y)`, and so it will return the same result as the `%` operator for arguments with the same sign and a different result for arguments that don't have the same sign.

Rounding up the result of dividing two positive integers (a/b) can be accomplished quickly as follows:

```
long result = (a + b - 1) / b;
```

The following is one example of this (we have $4/3 = 1.33$ and we want 2):

```
long result = (4 + 3 - 1) / 3; // 2
```

The following is another example of this (we have $17/7 = 2.42$ and we want 3):

```
long result = (17 + 7 - 1) / 7; // 3
```

If the integers are not positive, then we can rely on `Math.ceil()`:

```
long result = (long) Math.ceil((double) a/b);
```

36. Next floating-point value

Having an integer value such as 10 makes it very easy for us to obtain the next integer-point value, such as $10+1$ (in the direction of positive infinity) or $10-1$ (in the direction of negative infinity). Trying to achieve the same thing for `float` or `double` is not that easy as it is for integers.

Starting with JDK 6, the `Math` class has been enriched with the `nextAfter()` method. This method takes two arguments—the initial number (`float` or `double`) and the direction (`Float/Double.NEGATIVE/POSITIVE_INFINITY`)—and returns the next floating-point value. Here, it is a flavor of this method to return the next-floating point adjacent to 0.1 in the direction of negative infinity:

```
float f = 0.1f;

// 0.099999994
float nextf = Math.nextAfter(f, Float.NEGATIVE_INFINITY);
```

Starting with JDK 8, the `Math` class has been enriched with two methods that act as shortcuts for `nextAfter()` and are faster. These methods are `nextDown()` and `nextUp()`:

```
float f = 0.1f;

float nextdownf = Math.nextDown(f); // 0.099999994
float nextupf = Math.nextUp(f); // 0.10000001

double d = 0.1d;

double nextdownd = Math.nextDown(d); // 0.09999999999999999
double nextupd = Math.nextUp(d); // 0.10000000000000002
```

Therefore, `nextAfter()` in the direction of negative infinity is available via `Math.nextDown()` and `nextAfter()`, while in the direction of positive infinity, this is available via `Math.nextUp()`.

37. Multiplying two large int/long values and operation overflow

Let's dive into the solution starting from the `*` operator, as shown in the following example:

```
int x = 10;
int y = 5;
int z = x * y; // 50
```

This is a very simple approach and works fine for most of the computations that involve `int`, `long`, `float`, and `double` as well.

Now, let's apply this operator to the following two large numbers (multiply 2,147,483,647 with itself):

```
int x = Integer.MAX_VALUE;
int y = Integer.MAX_VALUE;
int z = x * y; // 1
```

This time, `z` will be equal to 1, which is not the expected result, that is, 4,611,686,014,132,420,609. Changing only the `z` type from `int` to `long` will not help. However, changing the types of `x` and `y` from `int` to `long` will:

```
long x = Integer.MAX_VALUE;
long y = Integer.MAX_VALUE;
long z = x * y; // 4611686014132420609
```

But the problem will reappear if we have `Long.MAX_VALUE` instead of `Integer.MAX_VALUE`:

```
long x = Long.MAX_VALUE;
long y = Long.MAX_VALUE;
long z = x * y; // 1
```

So, computations that overflow the domain and rely on the `*` operator will end up in misleading results.

Instead of using these results in further computations, it is better to be informed on time when an overflow operation occurred. JDK 8 comes with the `Math.multiplyExact()` method. This method tries to multiply two integers. If the result overflows, `int` will just throw `ArithmeticException`:

```
int x = Integer.MAX_VALUE;
int y = Integer.MAX_VALUE;
int z = Math.multiplyExact(x, y); // throw ArithmeticException
```



In JDK 8, `Math.multiplyExact(int x, int y)` returns `int` and `Math.multiplyExact(long x, long y)` returns `long`. In JDK 9, `Math.multiplyExact(long, int y)` returning `long` was added as well.

JDK 9 comes with `Math.multiplyFull(int x, int y)` returning `long` value. This method is very useful for obtaining the exact mathematical product of two integers as `long`, as follows:

```
int x = Integer.MAX_VALUE;
int y = Integer.MAX_VALUE;
long z = Math.multiplyFull(x, y); // 4611686014132420609
```

Just for the record, JDK 9 also comes with a method named `Math.multiplyHigh(long x, long y)` returning a `long`. The `long` value returned by this method represents the most significant 64 bits of the 128-bit product of two 64-bit factors:

```
long x = Long.MAX_VALUE;
long y = Long.MAX_VALUE;
// 9223372036854775807 * 9223372036854775807 = 4611686018427387903
long z = Math.multiplyHigh(x, y);
```

In a functional style context, a potential solution will rely on the `BinaryOperator` functional interface, as follows (simply define the operation of the two operands of the same type):

```
int x = Integer.MAX_VALUE;
int y = Integer.MAX_VALUE;
BinaryOperator<Integer> operator = Math::multiplyExact;
int z = operator.apply(x, y); // throw ArithmeticException
```

For working with a large number, also focus on the `BigInteger` (immutable arbitrary-precision integers) and `BigDecimal` (immutable, arbitrary-precision signed decimal numbers) classes.

38. Fused Multiply Add

The mathematical computation $(a * b) + c$ is heavily exploited in matrix multiplications, which are frequently used in **High-Performance Computing (HPC)**, AI applications, machine learning, deep learning, neural networks, and so on.

The simplest way to implement this computation relies directly on the `*` and `+` operators, as follows:

```
double x = 49.29d;
double y = -28.58d;
double z = 33.63d;
double q = (x * y) + z;
```

The main problem of this implementation consists of low accuracy and performance caused by two rounding errors (one for the multiply operation and one for the addition operation).

But thanks to Intel AVX's instructions for performing SIMD operations and to JDK 9, which added the `Math.fma()` method, this computation can be boosted. By relying on `Math.fma()`, the rounding is done only once using the round to nearest even rounding mode:

```
double fma = Math.fma(x, y, z);
```

Notice that this improvement is available for modern Intel processors, so it is not enough to just have JDK 9 in place.

39. Compact number formatting

Starting with JDK 12, a new class for compact number formatting was added. This class is named `java.text.CompactNumberFormat`. The main goal of this class is to extend the existing Java number formatting API with support for locale and compaction.

A number can be formatted into a short style (for example, *1000* becomes *1K*) or into a long style (for example, *1000* becomes *1 thousand*). These two styles were grouped in the `Style` enum as `SHORT` and `LONG`.

Besides the `CompactNumberFormat` constructor, `CompactNumberFormat` can be created via two static methods that are added to the `NumberFormat` class:

- The first is a compact number format for the default locale with `NumberFormat.Style.SHORT`:

```
public static NumberFormat getCompactNumberInstance()
```

- The second is a compact number format for the specified locale with `NumberFormat.Style`:

```
public static NumberFormat getCompactNumberInstance(  
    Locale locale, NumberFormat.Style formatStyle)
```

Let's take a close look at formatting and parsing.

Formatting

By default, a number is formatted using `RoundingMode.HALF_EVEN`. However, we can explicitly set the rounding mode via `NumberFormat.setRoundingMode()`.

Trying to condense this information into a utility class named `NumberFormatters` can be achieved as follows:

```
public static String forLocale(Locale locale, double number) {
    return format(locale, Style.SHORT, null, number);
}

public static String forLocaleStyle(
    Locale locale, Style style, double number) {
    return format(locale, style, null, number);
}

public static String forLocaleStyleRound(
    Locale locale, Style style, RoundingMode mode, double number) {
    return format(locale, style, mode, number);
}

private static String format(
    Locale locale, Style style, RoundingMode mode, double number) {
    if (locale == null || style == null) {
        return String.valueOf(number); // or use a default format
    }

    NumberFormat nf = NumberFormat.getCompactNumberInstance(locale,
        style);

    if (mode != null) {
        nf.setRoundingMode(mode);
    }

    return nf.format(number);
}
```

Now, let's format the numbers `1000`, `1000000`, and `1000000000` with the US locale, SHORT style, and default rounding mode:

```
// 1K
NumberFormatters.forLocaleStyle(Locale.US, Style.SHORT, 1_000);

// 1M
NumberFormatters.forLocaleStyle(Locale.US, Style.SHORT, 1_000_000);
```

```
// 1B
NumberFormatters.forLocaleStyle(Locale.US, Style.SHORT,
    1_000_000_000);
```

We can do the same with the LONG style:

```
// 1thousand
NumberFormatters.forLocaleStyle(Locale.US, Style.LONG, 1_000);

// 1million
NumberFormatters.forLocaleStyle(Locale.US, Style.LONG, 1_000_000);

// 1billion
NumberFormatters.forLocaleStyle(Locale.US, Style.LONG, 1_000_000_000);
```

We can also use the ITALIAN locale and SHORT style:

```
// 1.000
NumberFormatters.forLocaleStyle(Locale.ITALIAN, Style.SHORT,
    1_000);

// 1 Mln
NumberFormatters.forLocaleStyle(Locale.ITALIAN, Style.SHORT,
    1_000_000);

// 1 Mld
NumberFormatters.forLocaleStyle(Locale.ITALIAN, Style.SHORT,
    1_000_000_000);
```

Finally, we can also use the ITALIAN locale and LONG style:

```
// 1 mille
NumberFormatters.forLocaleStyle(Locale.ITALIAN, Style.LONG,
    1_000);

// 1 milione
NumberFormatters.forLocaleStyle(Locale.ITALIAN, Style.LONG,
    1_000_000);

// 1 miliardo
NumberFormatters.forLocaleStyle(Locale.ITALIAN, Style.LONG,
    1_000_000_000);
```

Now, let's suppose that we have two numbers: 1200 and 1600.

From the rounding mode's perspective, they will be rounded to *1000* and *2000*, respectively. The default rounding mode, `HALF_EVEN`, will round *1200* to *1000* and *1600* to *2000*. But if we want *1200* to become *2000* and *1600* to become *1000*, then we need to explicitly set up the rounding mode as follows:

```
// 2000 (2 thousand)
NumberFormatters.forLocaleStyleRound(
    Locale.US, Style.LONG, RoundingMode.UP, 1_200);

// 1000 (1 thousand)
NumberFormatters.forLocaleStyleRound(
    Locale.US, Style.LONG, RoundingMode.DOWN, 1_600);
```

Parsing

Parsing is the reverse process of formatting. We have a given string and try to parse it as a number. This can be accomplished via the `NumberFormat.parse()` method. By default, parsing doesn't take advantage of grouping (for example, without grouping, *5,50 K* is parsed as *5*; with grouping, *5,50 K* is parsed as *550000*).

If we condense this information into a set of helper methods, then we obtain the following output:

```
public static Number parseLocale(Locale locale, String number)
    throws ParseException {

    return parse(locale, Style.SHORT, false, number);
}

public static Number parseLocaleStyle(
    Locale locale, Style style, String number) throws ParseException {

    return parse(locale, style, false, number);
}

public static Number parseLocaleStyleRound(
    Locale locale, Style style, boolean grouping, String number)
    throws ParseException {

    return parse(locale, style, grouping, number);
}

private static Number parse(
    Locale locale, Style style, boolean grouping, String number)
    throws ParseException {
```



```
    if (locale == null || style == null || number == null) {
        throw new IllegalArgumentException(
            "Locale/style/number cannot be null");
    }

    NumberFormat nf = NumberFormat.getCompactNumberInstance(locale,
        style);
    nf.setGroupingUsed(grouping);

    return nf.parse(number);
}
```

Let's parse *5K* and *5 thousand* into *5000* without explicit grouping:

```
// 5000
NumberFormatters.parseLocaleStyle(Locale.US, Style.SHORT, "5K");

// 5000
NumberFormatters.parseLocaleStyle(Locale.US, Style.LONG, "5
thousand");
```

Now, let's parse *5,50K* and *5,50 thousand* to *550000* with explicit grouping:

```
// 550000
NumberFormatters.parseLocaleStyleRound(
    Locale.US, Style.SHORT, true, "5,50K");

// 550000
NumberFormatters.parseLocaleStyleRound(
    Locale.US, Style.LONG, true, "5,50 thousand");
```

More tuning can be obtained via the `setCurrency()`, `setParseIntegerOnly()`, `setMaximumIntegerDigits()`, `setMinimumIntegerDigits()`, `setMinimumFractionDigits()`, and `setMaximumFractionDigits()` methods.

Summary

This chapter collected a bunch of the most common problems that involve strings and numbers. Obviously, there are tons of such problems, and trying to cover all of them is way beyond any book's scope. However, knowing how to solve the problems presented in this chapter provides you with a solid base for solving many other related problems by yourself.

Download the applications from this chapter to view the results and additional details.

2

Objects, Immutability, and Switch Expressions

This chapter includes 18 problems that involve objects, immutability, and `switch` expressions. The chapter starts with several problems about dealing with `null` references. It continues with problems regarding checking indexes, `equals()` and `hashCode()`, and immutability (for example, writing immutable classes and passing/returning mutable objects from immutable classes). The last part of the chapter deals with cloning objects and the JDK 12 `switch` expressions. By the end of this chapter, you will have a fundamental knowledge of objects and immutability. Moreover, you will know how to deal with the new `switch` expressions. These are valuable and non-optional bits of knowledge in any Java developer's arsenal.

Problems

Use the following problems to test your object, immutability, and `switch` expression programming prowess. I strongly encourage you to give each problem a try before you turn to the solutions and download the example programs:

40. **Checking `null` references in functional style and imperative code:** Write a program that performs the `null` checks on the given references in a functional style and imperative code.
41. **Checking `null` references and throwing a customized `NullPointerException` error:** Write a program that performs the `null` checks on the given references and throws `NullPointerException` with custom messages.
42. **Checking `null` references and throwing the specified exception (example, `IllegalArgumentException`):** Write a program that performs the `null` checks on the given references and throws the specified exception.

43. **Checking null references and returning non-null default references:** Write a program that performs the `null` checks on the given reference, and if it is non-`null`, then return it; otherwise, return a non-`null` default reference.
44. **Checking the index in the range from 0 to length:** Write a program that checks whether the given index is between 0 (inclusive) and the given length (exclusive). If the given index is out of the `[0, given length]` range, then throw `IndexOutOfBoundsException`.
45. **Checking the subrange in the range from 0 to length:** Write a program that checks whether the given subrange `[given start, given end]` is within the bounds of the range from `[0, given length]`. If the given subrange is not in the `[0, given length]` range, then throw `IndexOutOfBoundsException`.
46. `equals()` and `hashCode()`: Explain and exemplify how `equals()` and `hashCode()` methods work in Java.
47. **Immutable objects in a nutshell:** Explain and exemplify what is an immutable object in Java.
48. **Immutable string:** Explain why the `String` class is immutable.
49. **Writing an immutable class:** Write a program that represents an immutable class.
50. **Passing/returning mutable objects to/from an immutable class:** Write a program that passes and returns a mutable object to/from an immutable class.
51. **Writing an immutable class via the Builder pattern:** Write a program that represents an implementation of the Builder pattern in an immutable class.
52. **Avoiding bad data in immutable objects:** Write a program that prevents *bad data* in immutable objects.
53. **Cloning objects:** Write a program that exemplifies shallow and deep cloning techniques.
54. **Overriding `toString()`:** Explain and exemplify practices for overriding `toString()`.
55. **`switch` expressions:** Provide a brief overview of the `switch` expressions in JDK 12.
56. **Multiple case labels:** Write a snippet of code for exemplifying the JDK 12 `switch` with multiple case labels.
57. **Statement blocks:** Write a snippet of code for exemplifying the JDK 12 `switch` with case labels that point to a curly-braced block.

Solutions

The following sections describe solutions to each of the preceding problems. Remember that there usually isn't a single correct way to solve a particular problem. Also, remember that the explanations shown here include only the most interesting and important details needed to solve the problems. Download the example solutions to see additional details and to experiment with the programs at <https://github.com/PacktPublishing/Java-Coding-Problems>.

40. Checking null references in functional style and imperative code

Independent of functional style or imperative code, checking `null` references is a common and recommended technique used for mitigating the occurrence of famous `NullPointerException` exception. This kind of checking is heavily exploited for method arguments to ensure that the passing references will not cause `NullPointerException` or unexpected behavior.

For example, passing `List<Integer>` to a method may require at least two `null` checks. First, the method should ensure that the list reference itself is not `null`. Second, depending on how the list is used, the method should ensure that the list does not contain `null` objects:

```
List<Integer> numbers
    = Arrays.asList(1, 2, null, 4, null, 16, 7, null);
```

This list is passed to the following method:

```
public static List<Integer> evenIntegers(List<Integer> integers) {

    if (integers == null) {
        return Collections.EMPTY_LIST;
    }

    List<Integer> evens = new ArrayList<>();
    for (Integer nr: integers) {
        if (nr != null && nr % 2 == 0) {
            evens.add(nr);
        }
    }

    return evens;
}
```

Notice that the preceding code uses the classical checks relying on the `==` and `!=` operators (`integers==null, nr !=null`). Starting with JDK 8, the `java.util.Objects` class contains two methods that wrap the null checks based on these two operators: `object == null` was wrapped in `Objects.isNull()`, and `object != null` was wrapped in `Objects.nonNull()`.

Based on these methods, the preceding code can be rewritten as follows:

```
public static List<Integer> evenIntegers(List<Integer> integers) {  
  
    if (Objects.isNull(integers)) {  
        return Collections.EMPTY_LIST;  
    }  
  
    List<Integer> evens = new ArrayList<>();  
  
    for (Integer nr: integers) {  
        if (Objects.nonNull(nr) && nr % 2 == 0) {  
            evens.add(nr);  
        }  
    }  
  
    return evens;  
}
```

Now, the code is somehow more expressive, but this is not the main usage of these two methods. Actually, these two methods have been added for another purpose (conforming to API notes)—to be used as predicates in the Java 8 functional style code. In functional style code, the null checks can be accomplished as in the following examples:

```
public static int sumIntegers(List<Integer> integers) {  
  
    if (integers == null) {  
        throw new IllegalArgumentException("List cannot be null");  
    }  
  
    return integers.stream()  
        .filter(i -> i != null)  
        .mapToInt(Integer::intValue).sum();  
}  
  
public static boolean integersContainsNulls(List<Integer> integers) {  
  
    if (integers == null) {  
        return false;  
    }  
}
```

```
    }

    return integers.stream()
        .anyMatch(i -> i == null);
}
```

It is quite obvious that `i -> i != null` and `i -> i == null` are not expressed in the same style with the surrounding code. Let's replace these snippets of code with `Objects.nonNull()` and `Objects.isNull()`:

```
public static int sumIntegers(List<Integer> integers) {

    if (integers == null) {
        throw new IllegalArgumentException("List cannot be null");
    }

    return integers.stream()
        .filter(Objects::nonNull)
        .mapToInt(Integer::intValue).sum();
}

public static boolean integersContainsNulls(List<Integer> integers) {

    if (integers == null) {
        return false;
    }

    return integers.stream()
        .anyMatch(Objects::isNull);
}
```

Or, we can use the `Objects.nonNull()` and `Objects.isNull()` methods for arguments as well:

```
public static int sumIntegers(List<Integer> integers) {

    if (Objects.isNull(integers)) {
        throw new IllegalArgumentException("List cannot be null");
    }

    return integers.stream()
        .filter(Objects::nonNull)
        .mapToInt(Integer::intValue).sum();
}

public static boolean integersContainsNulls(List<Integer> integers) {

    if (Objects.isNull(integers)) {
```

```
        return false;
    }

    return integers.stream()
        .anyMatch(Objects::isNull);
}
```

Awesome! So, by way of conclusion, the functional style code should rely on these two methods whenever the `null` checks are needed, while in the imperative code, it is a matter of preference.

41. Checking null references and throwing customized `NullPointerException`

Checking `null` references and throwing `NullPointerException` with customized messages can be accomplished using the following code (this code does these four times, twice in the constructor and twice in the `assignDriver()` method):

```
public class Car {

    private final String name;
    private final Color color;

    public Car(String name, Color color) {

        if (name == null) {
            throw new NullPointerException("Car name cannot be null");
        }

        if (color == null) {
            throw new NullPointerException("Car color cannot be null");
        }

        this.name = name;
        this.color = color;
    }

    public void assignDriver(String license, Point location) {

        if (license == null) {
            throw new NullPointerException("License cannot be null");
        }

        if (location == null) {
            throw new NullPointerException("Location cannot be null");
        }
    }
}
```

```
    }  
  }  
}
```

So, this code solves the problem by combining the `==` operator and manual instantiation of the `NullPointerException` class. Starting with JDK 7, this combination of code was hidden in a static method named `Objects.requireNonNull()`. Via this method, the preceding code can be rewritten in an expressive manner:

```
public class Car {  
  
    private final String name;  
    private final Color color;  
  
    public Car(String name, Color color) {  
  
        this.name = Objects.requireNonNull(name, "Car name cannot be  
            null");  
        this.color = Objects.requireNonNull(color, "Car color cannot be  
            null");  
    }  
  
    public void assignDriver(String license, Point location) {  
  
        Objects.requireNonNull(license, "License cannot be null");  
        Objects.requireNonNull(location, "Location cannot be null");  
    }  
}
```

So, if the specified reference is null, then `Objects.requireNonNull()` will throw a `NullPointerException` with the message provided. Otherwise, it returns the checked reference.

In constructors, there is a typical approach to throw `NullPointerException` when the references provided are null. But in methods (for example, `assignDriver()`), this is a controversial approach. Some developers will prefer to return an inoffensive result or to throw `IllegalArgumentException`. The next problem, checking null references and throwing the specified exception (for example, `IllegalArgumentException`), addresses the `IllegalArgumentException` approach.

In JDK 7, there are the two `Objects.requireNonNull()` methods, the one used previously, and another one that throws `NullPointerException` with a default message, as in the following example:

```
this.name = Objects.requireNonNull(name);
```

Starting with JDK 8, there is one more `Objects.requireNonNull()`. This one wraps the custom message of `NullPointerException` in `Supplier`. This means that the message creation is postponed until the given reference is `null` (this means that using the `+` operator for concatenating parts of the message is no longer an issue).

Here is an example:

```
this.name = Objects.requireNonNull(name, ()
    -> "Car name cannot be null ... Consider one from " + carsList);
```

If this reference is not `null`, then the message is not created.

42. Checking null references and throwing the specified exception

Of course, one solution entails relying directly on the `==` operator as follows:

```
if (name == null) {
    throw new IllegalArgumentException("Name cannot be null");
}
```

This problem cannot be solved via the methods of `java.util.Objects` since there is no `requireNonNullElseThrow()` method. Throwing `IllegalArgumentException` or another specified exception may require a set of methods, as shown in following screenshot:

Ⓢ	<code>requireNonNullElseThrow(T obj, X exception)</code>	T
Ⓢ	<code>requireNonNullElseThrowIAE(T obj, String message)</code>	T
Ⓢ	<code>requireNonNullElseThrowIAE(T obj, Supplier<String> messageSupplier)</code>	T
Ⓢ	<code>requireNotNullElseThrow(T obj, Supplier<? extends X> exceptionSupplier)</code>	T

Let's focus on the `requireNonNullElseThrowIAE()` methods. These two methods throw `IllegalArgumentException` with a custom message specified as `String` or as `Supplier` (to avoid creation until `null` is evaluated to `true`):

```
public static <T> T requireNonNullElseThrowIAE(
    T obj, String message) {

    if (obj == null) {
        throw new IllegalArgumentException(message);
    }

    return obj;
}

public static <T> T requireNonNullElseThrowIAE(T obj,
    Supplier<String> messageSupplier) {

    if (obj == null) {
        throw new IllegalArgumentException(messageSupplier == null
            ? null : messageSupplier.get());
    }

    return obj;
}
```

So, throwing `IllegalArgumentException` can be done via these two methods. But they are not enough. For example, the code may need to throw `IllegalStateException`, `UnsupportedOperationException`, and so on. For such cases, the following methods are preferable:

```
public static <T, X extends Throwable> T requireNonNullElseThrow(
    T obj, X exception) throws X {

    if (obj == null) {
        throw exception;
    }

    return obj;
}

public static <T, X extends Throwable> T requireNotNullElseThrow(
    T obj, Supplier<<? extends X> exceptionSupplier) throws X {

    if (obj != null) {
        return obj;
    } else {
        throw exceptionSupplier.get();
    }
}
```

```
    }  
}
```

Consider adding these methods to a helper class named `MyObjects`. Call these methods as shown in the following example:

```
public Car(String name, Color color) {  
  
    this.name = MyObjects.requireNonNullElseThrow(name,  
        new UnsupportedOperationException("Name cannot be set as null"));  
    this.color = MyObjects.requireNonNullElseThrow(color, () ->  
        new UnsupportedOperationException("Color cannot be set as null"));  
}
```

Furthermore, we can follow these examples to enrich `MyObjects` with other kinds of exceptions as well.

43. Checking null references and returning non-null default references

A solution to this problem can easily be provided via `if-else` (or the ternary operator), as in the following example (as a variation, `name`, and `color` can be declared as `non-final` and initialized with the default values at declaration):

```
public class Car {  
  
    private final String name;  
    private final Color color;  
    public Car(String name, Color color) {  
  
        if (name == null) {  
            this.name = "No name";  
        } else {  
            this.name = name;  
        }  
  
        if (color == null) {  
            this.color = new Color(0, 0, 0);  
        } else {  
            this.color = color;  
        }  
    }  
}
```

However, starting with JDK 9, the preceding code can be simplified via two methods from the `Objects` class. These methods are `requireNonNullElse()` and `requireNonNullElseGet()`. Both of them take two arguments—the reference to check for nullity, and the non-null default reference to return in case the checked reference is null:

```
public class Car {  
  
    private final String name;  
    private final Color color;  
  
    public Car(String name, Color color) {  
  
        this.name = Objects.requireNonNullElse(name, "No name");  
        this.color = Objects.requireNonNullElseGet(color,  
            () -> new Color(0, 0, 0));  
    }  
}
```

In the preceding example, these methods are used in a constructor, but they can be used in methods as well.

44. Checking the index in the range from 0 to length

To begin with, let's have a simple scenario to highlight this problem. This scenario may materialize in the following simple class:

```
public class Function {  
  
    private final int x;  
  
    public Function(int x) {  
  
        this.x = x;  
    }  
  
    public int xMinusY(int y) {  
  
        return x - y;  
    }  
  
    public static int oneMinusY(int y) {
```

```
        return 1 - y;
    }
}
```

Notice that the preceding snippet of code doesn't assume any range restrictions over x and y . Now, let's impose the following ranges (this is very common with mathematical functions):

- x must be between 0 (inclusive) and 11 (exclusive), so x belongs to $[0, 11]$.
- In the `xMinusY()` method, y must be between 0 (inclusive) and x (exclusive), so y belongs to $[0, x]$.
- In the `oneMinusY()` method, y must be between 0 (inclusive) and 16 (exclusive), so y belongs to $[0, 16]$.

These ranges can be imposed in code via the `if` statements, as follows:

```
public class Function {

    private static final int X_UPPER_BOUND = 11;
    private static final int Y_UPPER_BOUND = 16;
    private final int x;

    public Function(int x) {

        if (x < 0 || x >= X_UPPER_BOUND) {
            throw new IndexOutOfBoundsException("...");
        }

        this.x = x;
    }

    public int xMinusY(int y) {

        if (y < 0 || y >= x) {
            throw new IndexOutOfBoundsException("...");
        }

        return x - y;
    }

    public static int oneMinusY(int y) {

        if (y < 0 || y >= Y_UPPER_BOUND) {
            throw new IndexOutOfBoundsException("...");
        }
    }
}
```

```
        return 1 - y;
    }
}
```

Consider replacing `IndexOutOfBoundsException` with a more meaningful exception (for example, extend `IndexOutOfBoundsException` and create a custom exception of type, `RangeOutOfBoundsException`).

Starting with JDK 9, the code can be rewritten to use the `Objects.checkIndex()` method. This method verifies whether the given index is in the range `[0, length]` and returns the given index in this range or throws `IndexOutOfBoundsException`:

```
public class Function {

    private static final int X_UPPER_BOUND = 11;
    private static final int Y_UPPER_BOUND = 16;
    private final int x;

    public Function(int x) {

        this.x = Objects.checkIndex(x, X_UPPER_BOUND);
    }

    public int xMinusY(int y) {

        Objects.checkIndex(y, x);

        return x - y;
    }

    public static int oneMinusY(int y) {

        Objects.checkIndex(y, Y_UPPER_BOUND);

        return 1 - y;
    }
}
```

For example, calling `oneMinusY()`, as shown in the next code snippet, will result in `IndexOutOfBoundsException` since `y` can take values between `[0, 16)`:

```
int result = Function.oneMinusY(20);
```

Now, let's go further and check the subrange in a range from 0 to the given length.

45. Checking the subrange in the range from 0 to length

Let's follow the same flow from the previous problem. So, this time, the `Function` class will look as follows:

```
public class Function {  
    private final int n;  
    public Function(int n) {  
        this.n = n;  
    }  
    public int yMinusX(int x, int y) {  
        return y - x;  
    }  
}
```

Notice that the preceding snippet of code doesn't assume any range restrictions over x , y , and n . Now, let's impose the following ranges:

- n must be between 0 (inclusive) and 101 (exclusive), so n belongs to $[0, 101]$.
- In the `yMinusX()` method, the range bounded by x and y , $[x, y]$ must be a subrange of $[0, n]$.

These ranges can be imposed in code via the `if` statements as follows:

```
public class Function {  
    private static final int N_UPPER_BOUND = 101;  
    private final int n;  
    public Function(int n) {  
        if (n < 0 || n >= N_UPPER_BOUND) {  
            throw new IndexOutOfBoundsException("...");  
        }  
        this.n = n;  
    }  
    public int yMinusX(int x, int y) {
```

```
    if (x < 0 || x > y || y >= n) {
        throw new IndexOutOfBoundsException("...");
    }

    return y - x;
}
}
```

Based on the previous problem, the condition for `n` can be replaced with `Objects.checkIndex()`. Moreover, the JDK 9 `Objects` class comes with a method named `checkFromToIndex(int start, int end, int length)` that checks whether the given subrange [*given start*, *given end*] is within the bounds of the range from `[0, given length]`. So, this method can be applied to the `yMinusX()` method to check that the range bounded by `x` and `y`, `[x, y]` is a subrange of `[0, n]`:

```
public class Function {

    private static final int N_UPPER_BOUND = 101;
    private final int n;

    public Function(int n) {

        this.n = Objects.checkIndex(n, N_UPPER_BOUND);
    }

    public int yMinusX(int x, int y) {

        Objects.checkFromToIndex(x, y, n);
        return y - x;
    }
}
```

For example, the following test will lead to `IndexOutOfBoundsException` since `x` is greater than `y`:

```
Function f = new Function(50);
int r = f.yMinusX(30, 20);
```



Beside this method, `Objects` come with another method named `checkFromIndexSize(int start, int size, int length)`. This method checks that the subrange [*given start*, *given start* + *given size*] is in the range `[0, given length]`.

46. equals() and hashCode()

The `equals()` and `hashCode()` methods are defined in `java.lang.Object`. Since `Object` is the superclass of all Java objects, these two methods are available for all objects. Their main goal is to provide an easy, efficient, and robust solution for comparing objects, and to determine whether they are equal. Without these methods and their contracts, the solution relies on the big and cumbersome `if` statements meant to compare each field of an object.

When these methods are not overridden, Java will use their default implementations. Unfortunately, the default implementation is not really serving the goal of determining whether two objects have the same value. By default, `equals()` checks *identity*. In other words, it considers that two objects are equal if, and only if, they are represented by the same memory address (same object references), while `hashCode()` returns an integer representation of the object memory address. This is a native function known as the *identity hash code*.

For example, let's assume the following class:

```
public class Player {  
  
    private int id;  
    private String name;  
  
    public Player(int id, String name) {  
  
        this.id = id;  
        this.name = name;  
    }  
}
```

Then, let's create two instances of this class containing the same information, and let's compare them for equality:

```
Player p1 = new Player(1, "Rafael Nadal");  
Player p2 = new Player(1, "Rafael Nadal");  
  
System.out.println(p1.equals(p2)); // false  
System.out.println("p1 hash code: " + p1.hashCode()); // 1809787067  
System.out.println("p2 hash code: " + p2.hashCode()); // 157627094
```



Do not use the `==` operator for testing the equality of objects (avoid `if (p1 == p2)`). The `==` operator compares whether the references of two objects are pointing to the same object, whereas `equals()` compares object values (as humans, this is what we care about).

As a rule of thumb, if two variables hold the same reference, they are *identical*, but if they reference the same value, they are *equal*. What *the same value* means is defined by `equals()`.

For us, `p1` and `p2` are equal, but notice that `equals()` has returned `false` (the `p1` and `p2` instances have exactly the same field values, but they are stored at different memory addresses). This means that relying on the default implementation of `equals()` is not acceptable. The solution is to override this method, and for this it is important to be aware of the `equals()` contract that imposes the following statements:

- **Reflexivity:** An object is equal to itself, which means that `p1.equals(p1)` must return `true`.
- **Symmetry:** `p1.equals(p2)` must return the same result (`true/false`) as `p2.equals(p1)`.
- **Transitive:** If `p1.equals(p2)` and `p2.equals(p3)`, then also `p1.equals(p3)`.
- **Consistent:** Two equal objects must remain equal all the time unless one of them is changed.
- **Null returns false:** All objects must be unequal to `null`.

So, in order to respect this contract, the `equals()` method of the `Player` class can be overridden as follows:

```
@Override
public boolean equals(Object obj) {

    if (this == obj) {
        return true;
    }

    if (obj == null) {
        return false;
    }

    if (getClass() != obj.getClass()) {
        return false;
    }
}
```

```
    }

    final Player other = (Player) obj;

    if (this.id != other.id) {
        return false;
    }

    if (!Objects.equals(this.name, other.name)) {
        return false;
    }

    return true;
}
```

Now, let's perform the equality test again (this time, `p1` is equal to `p2`):

```
System.out.println(p1.equals(p2)); // true
```

OK, so far so good! Now, let's add these two `Player` instances to a collection. For example, let's add them to a `HashSet` (a Java collection that doesn't allow duplicates):

```
Set<Player> players = new HashSet<>();
players.add(p1);
players.add(p2);
```

Let's check the size of this `HashSet` and whether it contains `p1`:

```
System.out.println("p1 hash code: " + p1.hashCode()); // 1809787067
System.out.println("p2 hash code: " + p2.hashCode()); // 157627094
System.out.println("Set size: " + players.size()); // 2
System.out.println("Set contains Rafael Nadal: "
    + players.contains(new Player(1, "Rafael Nadal"))); // false
```

Conforming to the preceding implementation of `equals()`, `p1`, and `p2` are equal; therefore, the `HashSet` size should be 1, not 2. Moreover, it should contain Rafael Nadal. So, what happened?

Well, the general answer resides in how Java was created. It is easy to intuit that `equals()` is not a fast method; therefore, lookups will face performance penalties when a significant number of equality comparisons are needed. For example, this adds a serious drawback in the case of lookups by specific values in collections (for example, `HashSet`, `HashMap`, and `HashTable`), since it may require a large number of equality comparisons.

Based on this statement, Java tried to reduce equality comparisons by adding *buckets*. A bucket is a hash-based container that groups equal objects. This means that equal objects should return the same hash code, while unequal objects should return different hash codes (if two unequal objects have the same hash code, then this is a *hash collision*, and the objects will go in the same bucket). So, Java compares the hash codes, and only if these are the same for two different object references (not for the same object references) does it proceed further and call `equals()`. Basically, this accelerates the lookups in collections.

But what happened in our case? Let's see it step by step:

- When `p1` is created, Java will assign to it a hash code based on the `p1` memory address.
- When `p1` is added to `Set`, Java will link a new bucket to the `p1` hash code.
- When `p2` is created, Java will assign to it a hash code based on the `p2` memory address.
- When `p2` is added to `Set`, Java will link a new bucket to the `p2` hash code (when this happens, it looks like `HashSet` is not working as expected and it allows duplicates).
- When `players.contains(new Player(1, "Rafael Nadal"))` is executed, a new player, `p3`, is created with a new hash code based on the `p3` memory address.
- So, in the frame of `contains()`, testing `p1` and `p3`, respectively, `p2` and `p3`, for equality involves checking their hash codes, and since the `p1` hash code is different from the `p3` hash code, and the `p2` hash code is different from the `p3` hash code, the comparisons stop without evaluating `equals()` and this means that `HashSet` doesn't contain the object (`p3`)

In order to get back on track, the code must override the `hashCode()` method as well. The `hashCode()` contract imposes the following:

- Two equal objects conforming to `equals()` must return the same hash code.
- Two objects with the same hash code are not mandatory equals.
- As long as the object remains unchanged, `hashCode()` must return the same value.

As a rule of thumb, in order to respect the `equals()` and `hashCode()` contracts, follow two golden rules:

- When `equals()` is overridden, `hashCode()` must be overridden as well, and vice versa.
- Use the same identifying attributes for both methods in the same order.

For the `Player` class, `hashCode()` can be overridden as follows:

```
@Override
public int hashCode() {

    int hash = 7;
    hash = 79 * hash + this.id;
    hash = 79 * hash + Objects.hashCode(this.name);

    return hash;
}
```

Now, let's execute another test (this time, it works as expected):

```
System.out.println("p1 hash code: " + p1.hashCode()); // -322171805
System.out.println("p2 hash code: " + p2.hashCode()); // -322171805
System.out.println("Set size: " + players.size()); // 1
System.out.println("Set contains Rafael Nadal: "
    + players.contains(new Player(1, "Rafael Nadal"))); // true
```

Now, let's enumerate some of the common mistakes of working with `equals()` and `hashCode()`:

- You override `equals()` and forget to override `hashCode()` or vice versa (override both or none).
- You use the `==` operator instead of `equals()` for comparing object values.
- In `equals()`, you omit one or more of the following:
 - Start by adding the *self-check* (`if (this == obj)...`).
 - Since no instance should be equal to `null`, continue by adding *null-check* (`if(obj == null)...`).
 - Ensure that the instance is what we are expecting (use `getClass()` or `instanceof`).
 - Finally, after these corner-cases, add field comparisons.

- You violate `equals()` symmetry via inheritance. Assume a class `A` and a class `B` extending `A` and adding a new field. The `B` class overrides the `equals()` implementation inherited from `A`, and this implementation is added to the new field. Relying on `instanceof` will reveal that `b.equals(a)` will return `false` (as expected), but `a.equals(b)` will return `true` (not expected), so therefore symmetry is broken. Relying on *slice comparison* will not work since this breaks transitivity and reflexivity. Fixing the problem means relying on `getClass()` instead of `instanceof` (via `getClass()`, instances of the type and its subtypes cannot be equal), or better relying on composition instead of inheritance as in the application bundled to this book (`P46_ViolateEqualsViaSymmetry`).
- You return a constant from `hashCode()` instead of a unique hash code per object.

Since JDK 7, the `Objects` class has come with several helpers for dealing with object equality and hash codes, as follows:

- `Objects.equals(Object a, Object b)`: Tests whether the `a` object is equal to the `b` object.
- `Objects.deepEquals(Object a, Object b)`: Useful for testing whether two objects are equal (if they are arrays, the test is performed via `Arrays.deepEquals()`).
- `Objects.hash(Object ... values)`: Generates a hash code for a sequence of input values.

Ensure that `equals()` and `hashCode()` respect the Java SE contracts via the `EqualsVerifier` library (<https://mvnrepository.com/artifact/nl.jqno.equalsverifier/equalsverifier>).



TIP

Rely on the Lombok library to generate `hashCode()` and `equals()` from the fields of your object (<https://projectlombok.org/>). But pay attention to the special case of combining Lombok with JPA entities.

47. Immutable objects in a nutshell

An immutable object is an object that cannot be changed (its state is fixed) once it is created.

In Java, the following applies:

- Primitive types are immutable.
- The famous Java `String` class is immutable (other classes are immutable as well, for example, `Pattern`, and `LocalDate`)
- Arrays are not immutable.
- Collections can be mutable, unmodifiable, or immutable.

An unmodifiable collection is not automatically immutable. It depends on which objects are stored in the collection. If the stored objects are mutable, then the collection is mutable and unmodifiable. But if the stored objects are immutable, then the collection is effectively immutable.

Immutable objects are useful in concurrent (multithread) applications and streams. Since immutable objects cannot be changed, they are impassible to concurrency issues and they don't risk being corrupted or inconsistent.

One of the main concerns of using immutable objects is related to the penalties of creating new objects, instead of managing the state of a mutable object. But keep in mind that immutable objects take advantage of special treatment during garbage collection. Moreover, they are not prone to concurrency issues and eliminate the code needed for managing the state of the mutable objects. The code necessary to manage the state of mutable objects is prone to be slower than the creation of new objects.

Looking at the following problems will allow us to dive deeper into object immutability in Java.

48. Immutable string

Every programming language has a way of representing strings. As primitive types, strings are part of the predefined types, and they are used in almost every type of Java application.

In Java, strings are not represented by a primitive type like `int`, `long`, and `float`. They are represented by a reference type named `String`. Almost any Java application uses strings, for example, the `main()` method of a Java application gets as an argument an array of the `String` type.

The notoriety of `String` and its wide range of applications means we should know it in detail. Besides knowing how to declare and manipulate strings (for example, reverse, and capitalize) developers should understand why this class was designed in a special or different way. More precisely, why is `String` immutable? Or maybe this question has a better resonance formulated like this—what are the pros and cons of `String` being immutable?

Pros of string immutability

Let's take a look at some of the pros of string immutability in the next section.

String constant pool or cached pool

One of the reasons in favor of string immutability is represented by the **string constant pool (SCP)** or cached pool. In order to understand this statement, let's dive a little bit into how the `String` class works internally.

The SCP is a special area in memory (not the normal heap memory) used for the storage of string literals. Let's assume the following three `String` variables:

```
String x = "book";  
String y = "book";  
String z = "book";
```

How many `String` objects have been created? It is tempting to say three, but actually Java creates only one `String` object with the "book" value. The idea is that everything between quotes is considered as a string literal, and Java stores string literals in this special area of memory called the SCP, by following an algorithm like this (this algorithm is known as **string interning**):

- When a string literal is created (for example, `String x = "book"`), Java inspects the SCP to see whether this string literal exists.
- If the string literal is not found in the SCP, then a new string object for the string literal is created in the SCP and the corresponding variable, `x`, will point to it.

- If the string literal is found in the SCP (for example, `String y = "book", String z = "book"`), then the new variable will point to the `String` object (basically, all variables that have the same value will point to the same `String` object):

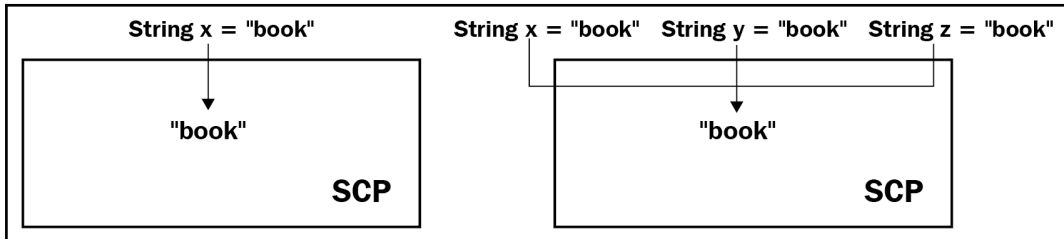

But `x` should be `"cook"` and not `"book"`, so let's replace `"b"` with `"c"`—`x = x.replace("b", "c");`

While `x` should be `"cook"`, `y` and `z` should remain unchanged. This behavior is provided by immutability. Java will create a new object and will perform the change on it as follows:

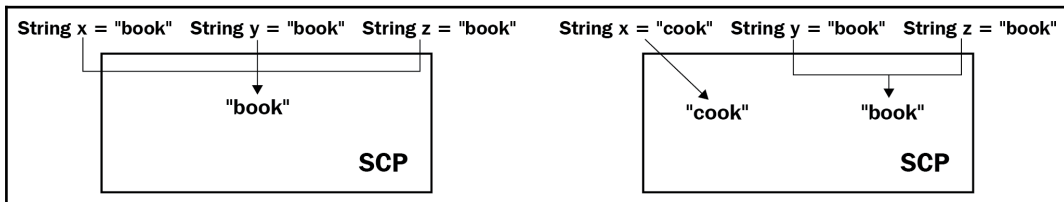

So, string immutability permits the caching of string literals, which allows applications to use a large number of string literals with a minimum impact on the heap memory and garbage collector. In a mutable context, a modification of a string literal may lead to corrupted variables.



Do not create a string as `String x = new String("book")`. This is not a string literal; this is a `String` instance (built via a constructor) that will go in the normal memory heap instead of the SCP. A string created in the normal heap memory can point to the SCP by explicitly calling the `String.intern()` method as `x.intern()`.

Security

Another benefit of string immutability is its security aspect. Commonly, a lot of sensitive information (usernames, passwords, URLs, ports, databases, socket connections, parameters, properties, and so on) are represented and passed around as strings. By having this information immutable, the code becomes secure to a wide range of security threats (for example, modifying the references accidentally or deliberately).

Thread safety

Imagine an application using thousands of mutable `String` objects and dealing with thread-safety code. Fortunately, in this case, our imagined scenario will not become a reality, thanks to immutability. Any immutable object is thread-safe by its nature. This means that strings can be shared and manipulated by multiple threads, with no risk of corruption and inconsistency.

Hash code caching

The *equals()* and *hashCode()* section discussed `equals()` and `hashCode()`. Hash codes should be calculated every time they are involved in hashing specific activities (for example, searching an element in a collection). Since `String` is immutable, every string has an immutable hash code that can be cached and reused as it cannot be changed after string creation. This means that hash codes of strings can be used from the cache instead of recalculating them at each usage. For example, `HashMap` hashes its keys for different operations (for example, `put()`, `get()`), and if these keys are of the `String` type, then hash codes will be reused from the cache instead of recalculating them.

Class loading

A typical approach for loading a class in memory relies on calling the `Class.forName(String className)` method. Notice the `String` argument representing the class name. Thanks to string immutability, the class name cannot be changed during the loading process. However, if `String` is mutable, then imagine loading class `A` (for example, `Class.forName("A")`), and, during the loading process, its name will get changed to `BadA`. Now, the `BadA` objects can do bad things!

Cons of string immutability

Let's take a look at some of the cons of string immutability in the next section.

String cannot be extended

An immutable class should be declared `final` to avoid extensibility. However, developers need to extend the `String` class in order to add more features, and this limitation can be considered a drawback of immutability.

Nevertheless, developers can write utility classes (for example, Apache Commons Lang, `StringUtils`, Spring Framework, `StringUtils`, Guava, and `strings`) to provide extra features and simply pass strings as arguments to the methods of these classes.

Sensitive data in memory for a long time

Sensitive data in strings (for example, passwords) may reside in memory (in SCP) for a long time. Being a cache, the SCP takes advantage of special treatment from the garbage collector. More precisely, the SCP is not visited by the garbage collector with the same frequency (cycles) as other memory zones. As a consequence of this special treatment, sensitive data is kept in the SCP for a long time, and can be prone to unwanted usages.

In order to avoid this potential drawback, it is advisable to store sensitive data (for example, passwords) in `char[]` instead of `String`.

OutOfMemoryError

The SCP is a small memory zone in comparison with others and can be filled pretty quickly. Storing too many string literals in the SCP will lead to `OutOfMemoryError`.

Is String completely immutable?

Well, behind the scenes, `String` uses `private final char[]` to store each character of the string. By using the Java Reflection API, in JDK 8, the following code will modify this `char[]` (the same code in JDK 11 will throw `java.lang.ClassCastException`):

```
String user = "guest";
System.out.println("User is of type: " + user);
```

```
Class<String> type = String.class;
Field field = type.getDeclaredField("value");
field.setAccessible(true);

char[] chars = (char[]) field.get(user);

chars[0] = 'a';
chars[1] = 'd';
chars[2] = 'm';
chars[3] = 'i';
chars[4] = 'n';

System.out.println("User is of type: " + user);
```

So, in JDK 8, `String` is *effectively* immutable, but not *completely*.

49. Writing an immutable class

An immutable class must respect several requirements, such as the following:

- The class should be marked as `final` to suppress extensibility (other classes cannot extend this class; therefore, they cannot override methods)
- All fields should be declared `private` and `final` (they are not visible in other classes, and they are initialized only once in the constructor of this class)
- The class should contain a parameterized `public` constructor (or a `private` constructor and factory methods for creating instances) that initializes the fields
- The class should provide getters for fields
- The class should not expose setters

For example, the following `Point` class is immutable since it successfully passes the preceding checklist:

```
public final class Point {

    private final double x;
    private final double y;

    public Point(double x, double y) {
        this.x = x;
        this.y = y;
    }
}
```

```
public double getX() {  
    return x;  
}  
  
public double getY() {  
    return y;  
}  
}
```

If the immutable class should manipulate mutable objects, consider the following problems.

50. Passing/returning mutable objects to/from an immutable class

Passing mutable objects to an immutable class can break down immutability. Let's consider the following mutable class:

```
public class Radius {  
  
    private int start;  
    private int end;  
  
    public int getStart() {  
        return start;  
    }  
  
    public void setStart(int start) {  
        this.start = start;  
    }  
  
    public int getEnd() {  
        return end;  
    }  
  
    public void setEnd(int end) {  
        this.end = end;  
    }  
}
```

Then, let's pass an instance of this class to an immutable class named, `Point`. At first glance, the `Point` class can be written as follows:

```
public final class Point {  
  
    private final double x;  
    private final double y;  
    private final Radius radius;  
  
    public Point(double x, double y, Radius radius) {  
        this.x = x;  
        this.y = y;  
        this.radius = radius;  
    }  
  
    public double getX() {  
        return x;  
    }  
  
    public double getY() {  
        return y;  
    }  
  
    public Radius getRadius() {  
        return radius;  
    }  
}
```

Is this class still immutable? The answer is—no. The `Point` class is not immutable anymore because its state can be changed as in the following example:

```
Radius r = new Radius();  
r.setStart(0);  
r.setEnd(120);  
  
Point p = new Point(1.23, 4.12, r);  
  
System.out.println("Radius start: " + p.getRadius().getStart()); // 0  
r.setStart(5);  
System.out.println("Radius start: " + p.getRadius().getStart()); // 5
```

Notice that calling `p.getRadius().getStart()` returned two different results; therefore, the state of `p` has been changed, so `Point` is no longer immutable. A solution to this problem is cloning the `Radius` object and storing the clone as the field of `Point`:

```
public final class Point {

    private final double x;
    private final double y;
    private final Radius radius;

    public Point(double x, double y, Radius radius) {
        this.x = x;
        this.y = y;

        Radius clone = new Radius();
        clone.setStart(radius.getStart());
        clone.setEnd(radius.getEnd());

        this.radius = clone;
    }

    public double getX() {
        return x;
    }

    public double getY() {
        return y;
    }

    public Radius getRadius() {
        return radius;
    }
}
```

This time, the `Point` class immutability level has increased (calling `r.setStart(5)` will not affect the `radius` field since this field is a clone of `r`). But the `Point` class is not completely immutable because there is one more problem to solve—returning mutable objects from an immutable class can break down immutability. Check the following code that breaks down the immutability of `Point`:

```
Radius r = new Radius();
r.setStart(0);
r.setEnd(120);

Point p = new Point(1.23, 4.12, r);
```

```
System.out.println("Radius start: " + p.getRadius().getStart()); // 0
p.getRadius().setStart(5);
System.out.println("Radius start: " + p.getRadius().getStart()); // 5
```

Again, calling `p.getRadius().getStart()` returned two different results; therefore, the state of `p` has been changed. The solution consists of modifying the `getRadius()` method to return a clone of the `radius` field, as follows:

```
...
public Radius getRadius() {
    Radius clone = new Radius();
    clone.setStart(this.radius.getStart());
    clone.setEnd(this.radius.getEnd());

    return clone;
}
...
```

Now, the `Point` class is immutable again. Problem solved!



Before choosing the cloning technique/tool, in certain cases, it is advisable to take your time and analyze/learn different possibilities available in Java and third-party libraries (for example, check the *Cloning objects* section in this chapter). For shallow copies, the preceding technique can be the proper choice, but for deep copies, the code may need to rely on different approaches such as copy constructor, the `Cloneable` interface, or external libraries (for example, Apache Commons Lang `ObjectUtils`, JSON serialization with `Gson` or `Jackson`, or any others).

51. Writing an immutable class via the Builder pattern

When a class (immutable or mutable) has too many fields, it requires a constructor with many arguments. When some of those fields are required and others are optional, this class will need several constructors to cover all the possible combinations. This becomes cumbersome for the developer and for the user of the class. This is where the Builder pattern comes to the rescue.

According to the **Gang of Four (GoF)**—the Builder pattern separates the construction of a complex object from its representation so that the same construction process can create different representations.

The Builder pattern can be implemented as a separate class or as an inner static class. Let's focus on the second case. The `User` class has three required fields (nickname, password, and created) and three optional fields (email, firstname, and lastname).

Now, an immutable `User` class relying on the Builder pattern will appear as follows:

```
public final class User {

    private final String nickname;
    private final String password;
    private final String firstname;
    private final String lastname;
    private final String email;
    private final Date created;

    private User(UserBuilder builder) {
        this.nickname = builder.nickname;
        this.password = builder.password;
        this.created = builder.created;
        this.firstname = builder.firstname;
        this.lastname = builder.lastname;
        this.email = builder.email;
    }

    public static UserBuilder getBuilder(
        String nickname, String password) {
        return new User.UserBuilder(nickname, password);
    }

    public static final class UserBuilder {

        private final String nickname;
        private final String password;
        private final Date created;
        private String email;
        private String firstname;
        private String lastname;

        public UserBuilder(String nickname, String password) {
            this.nickname = nickname;
            this.password = password;
            this.created = new Date();
        }

        public UserBuilder firstName(String firstname) {
            this.firstname = firstname;
        }
    }
}
```

```
        return this;
    }

    public UserBuilder lastName(String lastname) {
        this.lastname = lastname;
        return this;
    }

    public UserBuilder email(String email) {
        this.email = email;
        return this;
    }

    public User build() {
        return new User(this);
    }
}

public String getNickname() {
    return nickname;
}

public String getPassword() {
    return password;
}

public String getFirstname() {
    return firstname;
}

public String getLastname() {
    return lastname;
}

public String getEmail() {
    return email;
}

public Date getCreated() {
    return new Date(created.getTime());
}
}
```

Here are some usage examples:

```
import static modern.challenge.User.getBuilder;
...
// user with nickname and password
```

```
User user1 = getBuilder("marin21", "hju9887h").build();

// user with nickname, password and email
User user2 = getBuilder("ionk", "44fef22")
    .email("ion@gmail.com")
    .build();

// user with nickname, password, email, firstname and lastname
User user3 = getBuilder("monika", "klooi0988")
    .email("monika@gmail.com")
    .firstName("Monika")
    .lastName("Ghuenther")
    .build();
```

52. Avoiding bad data in immutable objects

Bad data is any data that has a negative impact on the immutable object (for example, corrupted data). Most probably, this data comes from user inputs or from external data sources that are not under our direct control. In such cases, bad data can hit the immutable object, and the worst part is that there is no fix for it. An immutable object cannot be changed after creation; therefore, bad data will live happily as long as the object lives.

The solution to this problem is to validate all data that enters in an immutable object against a comprehensive set of constraints.

There are different ways of performing validation, from custom validation to built-in solutions. Validation can be performed outside or inside the immutable object class, depending on the application design. For example, if the immutable object is built via the Builder pattern, then the validation can be performed in the builder class.

JSR 380 is a specification of the Java API for bean validation (Java SE/EE) that can be used for validation via annotations. Hibernate Validator is the reference implementation of the validation API, and it can be easily provided as a Maven dependency in the `pom.xml` file (check the source code bundled to this book).

Furthermore, we rely on dedicated annotations to provide the needed constraints (for example, `@NotNull`, `@Min`, `@Max`, `@Size`, and `@Email`). In the following example, the constraints are added to the builder class as follows:

```
...
public static final class UserBuilder {

    @NotNull(message = "cannot be null")
```

```
@Size(min = 3, max = 20, message = "must be between 3 and 20
  characters")
private final String nickname;

@NotNull(message = "cannot be null")
@Size(min = 6, max = 50, message = "must be between 6 and 50
  characters")
private final String password;

@Size(min = 3, max = 20, message = "must be between 3 and 20
  characters")
private String firstname;

@Size(min = 3, max = 20, message = "must be between 3 and 20
  characters")
private String lastname;

@email(message = "must be valid")
private String email;

private final Date created;

public UserBuilder(String nickname, String password) {
    this.nickname = nickname;
    this.password = password;
    this.created = new Date();
}
...

```

Finally, the validation process is triggered from code via the `Validator` API (this is needed in Java SE only). If the data that enters the builder class is invalid, then the immutable object is not created (don't call the `build()` method):

```
User user;
Validator validator
    = Validation.buildDefaultValidatorFactory().getValidator();

User.UserBuilder userBuilder
    = new User.UserBuilder("monika", "klooi0988")
        .email("monika@gmail.com")
        .firstName("Monika").lastName("Gunther");

final Set<ConstraintViolation<User.UserBuilder>> violations
    = validator.validate(userBuilder);
if (violations.isEmpty()) {
    user = userBuilder.build();
    System.out.println("User successfully created on: "
        + user.getCreated());
}
```

```
    } else {  
        printConstraintViolations("UserBuilder Violations: ", violations);  
    }  
}
```

This way, the bad data cannot touch an immutable object. If there is no builder class, then the constraints can be added directly at the field level in the immutable object. The preceding solution simply displays the potential violations on the console, but, depending on the situation, the solution may perform different actions (for example, throw specific exceptions).

53. Cloning objects

Cloning objects is not a daily task, but it is important to do it properly. Mainly, cloning objects refers to creating copies of objects. There are two main types of copies—*shallow* copies (copy as little as possible) and *deep* copies (copy everything).

Let's assume the following class:

```
public class Point {  
  
    private double x;  
    private double y;  
  
    public Point() {}  
    public Point(double x, double y) {  
        this.x = x;  
        this.y = y;  
    }  
  
    // getters and setters  
}
```

So, we have a point of type (x, y) mapped in a class. Now, let's perform some cloning.

Manual cloning

A quick approach consists of adding a method that copies the current `Point` to a new `Point` manually (this is a shallow copy):

```
public Point clonePoint() {  
    Point point = new Point();  
    point.setX(this.x);  
    point.setY(this.y);  
}
```

```
    return point;
}
```

The code here is pretty simple. Just create a new instance of `Point` and populate its fields with the fields of the current `Point`. The returned `Point` is a shallow copy (since `Point` doesn't depend on other objects, a deep copy will be exactly the same) of the current `Point`:

```
Point point = new Point(...);
Point clone = point.clonePoint();
```

Cloning via `clone()`

The `Object` class contains a method named `clone()`. This method is useful for creating shallow copies (it can be used for deep copies as well). In order to use it, a class should follow the given steps:

- Implement the `Cloneable` interface (if this interface is not implemented, then `CloneNotSupportedException` will be thrown).
- Override the `clone()` method (`Object.clone()` is protected).
- Call `super.clone()`.

The `Cloneable` interface doesn't contain any methods. It is just a signal for JVM that this object can be cloned. Once this interface is implemented, the code needs to override the `Object.clone()` method. This is needed because `Object.clone()` is protected, and, in order to call it via `super`, the code needs to override this method. This can be a serious drawback if `clone()` is added to a child class since all superclasses should define a `clone()` method in order to avoid the failure of the `super.clone()` chain invocation.

Moreover, `Object.clone()` doesn't rely on a constructor invocation, and so the developer cannot control the object construction:

```
public class Point implements Cloneable {

    private double x;
    private double y;

    public Point() {}

    public Point(double x, double y) {
        this.x = x;
        this.y = y;
    }
}
```

```
    }

    @Override
    public Point clone() throws CloneNotSupportedException {
        return (Point) super.clone();
    }

    // getters and setters
}
```

Creating a clone can be done as follows:

```
Point point = new Point(...);
Point clone = point.clone();
```

Cloning via a constructor

This cloning technique requires you to enrich the class with a constructor that takes a single argument representing an instance of the class that will be used to create the clone.

Let's see it in code:

```
public class Point {

    private double x;
    private double y;

    public Point() {}

    public Point(double x, double y) {
        this.x = x;
        this.y = y;
    }

    public Point(Point another) {
        this.x = another.x;
        this.y = another.y;
    }

    // getters and setters
}
```

Creating a clone can be done as follows:

```
Point point = new Point(...);
Point clone = new Point(point);
```

Cloning via the Cloning library

A deep copy is needed when an object depends on another object. Performing a deep copy means copying the object, including its chain of dependencies. For example, let's assume that `Point` has a field of the `Radius` type:

```
public class Radius {  
  
    private int start;  
    private int end;  
  
    // getters and setters  
}  
  
public class Point {  
  
    private double x;  
    private double y;  
    private Radius radius;  
  
    public Point(double x, double y, Radius radius) {  
        this.x = x;  
        this.y = y;  
        this.radius = radius;  
    }  
  
    // getters and setters  
}
```

Performing a shallow copy of `Point` will create a copy of `x` and `y`, but will not create a copy of the `radius` object. This means that modifications that affect the `radius` object will be reflected in the clone as well. It's time for a deep copy.

A cumbersome solution will involve adapting the shallow copy techniques previously presented to support a deep copy. Fortunately, there are a few solutions that can be applied out of the box, and one of them is the Cloning library (<https://github.com/kostaskougios/cloning>):

```
import com.rits.cloning.Cloner;  
...  
Point point = new Point(...);  
Cloner cloner = new Cloner();  
Point clone = cloner.deepClone(point);
```

The code is self-explanatory. Notice that the Cloning library comes with several other goodies as well, as can be seen in the following screenshot:

● <code>deepClone (T o)</code>	T
● <code>deepCloneDontCloneInstances (T o, Object... dontCloneThese)</code>	T
● <code>fastCloneOrNewInstance (Class<T> c)</code>	T
● <code>shallowClone (T o)</code>	T
● <code>copyPropertiesOfInheritedClass (T src, E dest)</code>	void
● <code>dontClone (Class<?>... c)</code>	void
● <code>dontCloneInstanceOf (Class<?>... c)</code>	void
● <code>equals (Object obj)</code>	boolean
● <code>getClass ()</code>	Class<?>
● <code>getDumpCloned ()</code>	IDumpCloned
...	

Cloning via serialization

This technique requires serializable objects (implement `java.io.Serializable`). Basically, the object is serialized (`writeObject ()`) and deserialized (`readObject ()`) in a new object. A helper method able to accomplish this is listed as follows:

```
private static <T> T cloneThroughSerialization(T t) {
    try {
        ByteArrayOutputStream baos = new ByteArrayOutputStream();
        ObjectOutputStream oos = new ObjectOutputStream(baos);
        oos.writeObject(t);

        ByteArrayInputStream bais
            = new ByteArrayInputStream(baos.toByteArray());
        ObjectInputStream ois = new ObjectInputStream(bais);

        return (T) ois.readObject();
    } catch (IOException | ClassNotFoundException ex) {
        // log exception
        return t;
    }
}
```

So, the object is serialized in `ObjectOutputStream` and deserialized in `ObjectInputStream`. Cloning an object via this method can be accomplished as follows:

```
Point point = new Point(...);
Point clone = cloneThroughSerialization(point);
```

A built-in solution based on serialization is provided by Apache Commons Lang, via `SerializationUtils`. Among its methods, this class provides a method named `clone()` that can be used as follows:

```
Point point = new Point(...);
Point clone = SerializationUtils.clone(point);
```

Cloning via JSON

Almost any JSON library in Java can serialize any **Plain Old Java Object (POJO)** without any extra configuration/mapping required. Having a JSON library in the project (and many projects have) can save us from adding an extra library to provide deep cloning. Mainly, the solution can leverage the existing JSON library to get the same effect.

The following is an example using the `Gson` library:

```
private static <T> T cloneThroughJson(T t) {

    Gson gson = new Gson();
    String json = gson.toJson(t);

    return (T) gson.fromJson(json, t.getClass());
}

Point point = new Point(...);
Point clone = cloneThroughJson(point);
```

In addition to this, there is always the option of writing your own library dedicated to cloning objects.

54. Overriding `toString()`

The `toString()` method is defined in `java.lang.Object`, and the JDK comes with a default implementation of it. This default implementation is automatically used for all objects that are the subject of `print()`, `println()`, `printf()`, debugging during development, logging, informative messages in exceptions, and so on.

Unfortunately, the string representation of an object returned by the default implementation is not very informative. For example, let's consider the following `User` class:

```
public class User {
    private final String nickname;
    private final String password;
    private final String firstname;
    private final String lastname;
    private final String email;
    private final Date created;

    // constructor and getters skipped for brevity
}
```

Now, let's create an instance of this class, and let's print it on the console:

```
User user = new User("sparg21", "kkd454ffc",
    "Leopold", "Mark", "markl@yahoo.com");

System.out.println(user);
```

The output of this `println()` method will be something like the following:

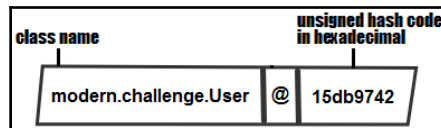

The solution for avoiding outputs as in the preceding screenshot consists of overriding the `toString()` method. For example, let's override it to expose the user details, as follows:

```
@Override
public String toString() {
    return "User{" + "nickname=" + nickname + ", password=" + password
        + ", firstname=" + firstname + ", lastname=" + lastname
        + ", email=" + email + ", created=" + created + '}';
}
```

This time, `println()` will reveal the following output:

```
User {
    nickname = sparg21, password = kkd454ffc,
    firstname = Leopold, lastname = Mark,
    email = markl@yahoo.com, created = Fri Feb 22 10: 49: 32 EET 2019
}
```

This is much more informative than the previous output.

But, remember that `toString()` is automatically called for different purposes. For example, logging can be as follows:

```
logger.log(Level.INFO, "This user rocks: {0}", user);
```

Here, the user password will hit the log, and this may represent a problem. Exposing log-sensitive data, such as passwords, accounts, and secret IPs, in an application is definitely a bad practice.

Therefore, pay extra attention to carefully selecting the information that goes in `toString()`, since this information may end up in places where it can be maliciously exploited. In our case, the password should not be part of `toString()`:

```
@Override
public String toString() {
    return "User{" + "nickname=" + nickname
        + ", firstname=" + firstname + ", lastname=" + lastname
        + ", email=" + email + ", created=" + created + '}';
}
```

Commonly, `toString()` is a method generated via an IDE. So, pay attention to which fields you select before the IDE generates the code for you.

55. Switch expressions

Before we have a brief overview of the `switch` expressions introduced in JDK 12, let's see a typical old-school example wrapped in a method:

```
private static Player createPlayer(PlayerTypes playerType) {

    switch (playerType) {

        case TENNIS:
            return new TennisPlayer();
        case FOOTBALL:
            return new FootballPlayer();
        case SNOOKER:
            return new SnookerPlayer();
        case UNKNOWN:
            throw new UnknownPlayerException("Player type is unknown");
        default:
            throw new IllegalArgumentException(
                "Invalid player type: " + playerType);
    }
}
```

```
    }  
}
```

If we forget about `default`, then the code will not compile.

Obviously, the preceding example is acceptable. In the worst-case scenario, we can add a spurious variable (for example, `player`), some cluttering `break` statements, and get no complaints if `default` is missing. So, the following code is an old-school, extremely ugly `switch`:

```
private static Player createPlayerSwitch(PlayerTypes playerType) {  
  
    Player player = null;  
  
    switch (playerType) {  
        case TENNIS:  
            player = new TennisPlayer();  
            break;  
        case FOOTBALL:  
            player = new FootballPlayer();  
            break;  
        case SNOOKER:  
            player = new SnookerPlayer();  
            break;  
        case UNKNOWN:  
            throw new UnknownPlayerException(  
                "Player type is unknown");  
        default:  
            throw new IllegalArgumentException(  
                "Invalid player type: " + playerType);  
    }  
  
    return player;  
}
```

If we forget about `default`, then there will be no complaints from the compiler side. In this case, a missing `default` case may result in a `null` `player`.

However, since JDK 12, we have been able to rely on the `switch` expressions. Before JDK 12, `switch` was a statement, a construct meant to control the flow (for example, as an `if` statement) without representing the result. On the other hand, an expression is evaluated to a result. Therefore, a `switch` expression can have a result.

The preceding `switch` expression can be written in the style of JDK 12 as follows:

```
private static Player createPlayer(PlayerTypes playerType) {  
  
    return switch (playerType) {  
        case TENNIS ->  
            new TennisPlayer();  
        case FOOTBALL ->  
            new FootballPlayer();  
        case SNOOKER ->  
            new SnookerPlayer();  
        case UNKNOWN ->  
            throw new UnknownPlayerException(  
                "Player type is unknown");  
        // default is not mandatory  
        default ->  
            throw new IllegalArgumentException(  
                "Invalid player type: " + playerType);  
    };  
}
```

This time, `default` is not mandatory. We can skip it.

The JDK 12 `switch` is smart enough to signal if `switch` doesn't cover all possible input values. This is very useful in the case of Java `enum` values. The JDK 12 `switch` can detect whether all the `enum` values are covered, and doesn't force a useless `default` if they aren't. For example, if we remove `default` and add a new entry to `PlayerTypes` `enum` (for example, `GOLF`), then the compiler will signal it via a message, as in the following screenshot (this is from NetBeans):

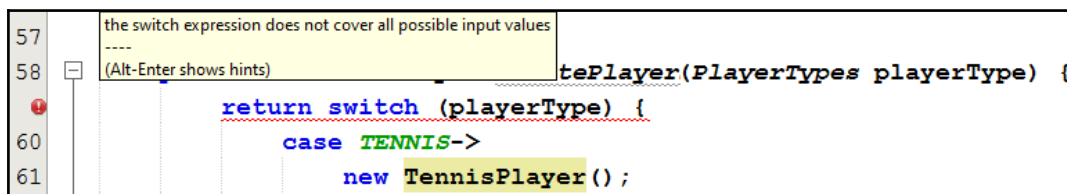

Notice that between the label and execution, we've replaced the colon with an arrow (the lambda-style syntax). The main role of this arrow is to prevent fall-through, which means that only the block of code from its right will be executed. There is no need to use `break`.

Do not conclude that the arrow turns the `switch` statement into a `switch` expression. A `switch` expression can be used with a colon and `break` as well, as follows:

```
private static Player createPlayer(PlayerTypes playerType) {  
  
    return switch (playerType) {  
        case TENNIS:  
            break new TennisPlayer();  
        case FOOTBALL:  
            break new FootballPlayer();  
        case SNOOKER:  
            break new SnookerPlayer();  
        case UNKNOWN:  
            throw new UnknownPlayerException(  
                "Player type is unknown");  
        // default is not mandatory  
        default:  
            throw new IllegalArgumentException(  
                "Invalid player type: " + playerType);  
    };  
}
```

Our example posts `switch` over `enum`, but the JDK 12 `switch` can also be used over `int`, `Integer`, `short`, `Short`, `byte`, `Byte`, `char`, `Character`, and `String`.



Notice that JDK 12 brings the `switch` expressions as a preview feature. This means that it is prone to changes in the next few releases, and it needs to be unlocked via the `--enable-preview` command-line option at compiling and runtime.

56. Multiple case labels

Before JDK 12, a `switch` statement allowed a single label per case. Starting with the `switch` expressions, a case can have multiple labels separated by a comma. Check out the following method that exemplifies multiple case labels:

```
private static SportType  
    fetchSportTypeByPlayerType(PlayerTypes playerType) {  
  
    return switch (playerType) {  
        case TENNIS, GOLF, SNOOKER ->  
            new Individual();  
        case FOOTBALL, VOLLEY ->
```

```
        new Team();
    };
}
```

So, if we pass to this method `TENNIS`, `GOLF`, or `SNOOKER`, it will return an instance of the `Individual` class. If we pass `FOOTBALL` or `VOLLEY`, it will return an instance of the `Team` class.

57. Statement blocks

A label's arrow can point to a single statement (as in the examples from the previous two problems) or to a curly-braced block. This is pretty similar to the lambda blocks. Check out the following solution:

```
private static Player createPlayer(PlayerTypes playerType) {
    return switch (playerType) {
        case TENNIS -> {
            System.out.println("Creating a TennisPlayer ...");
            break new TennisPlayer();
        }
        case FOOTBALL -> {
            System.out.println("Creating a FootballPlayer ...");
            break new FootballPlayer();
        }
        case SNOOKER -> {
            System.out.println("Creating a SnookerPlayer ...");
            break new SnookerPlayer();
        }
        default ->
            throw new IllegalArgumentException(
                "Invalid player type: " + playerType);
    };
}
```



Notice that we exit from a curly-braced block via `break`, not `return`. In other words, while we can return from inside a switch statement, we can't return from within an expression.

Summary

That's all folks! This chapter has introduced you to several problems involving objects, immutability, and the `switch` expressions. While the problems covering objects and immutability represent fundamental concepts of programming, the problems covering the `switch` expressions were dedicated to introducing the new JDK 12 features addressing this topic.

Download the applications from this chapter to see the results and to see additional details.

3

Working with Date and Time

This chapter includes 20 problems that involve date and time. These problems are meant to cover a wide range of topics (converting, formatting, adding, subtracting, defining periods/durations, computing, and so on) via `Date`, `Calendar`, `LocalDate`, `LocalTime`, `LocalDateTime`, `ZoneDateTime`, `OffsetDateTime`, `OffsetTime`, `Instant`, and so on. By the end of this chapter, you will have no problems in shaping date and time, while conforming to your application's needs. The fundamental problems presented in this chapter will be very helpful for obtaining the bigger picture regarding date-time APIs, and will act like the pieces of the puzzle that need to be pieced together in order to resolve complex challenges involving date and time.

Problems

Use the following problems to test your date and time programming prowess. I strongly encourage you to give each problem a try before you turn to the solutions and download the example programs:

58. **Converting a string to date and time:** Write a program that exemplifies conversions between a string and date/time.
59. **Formatting date and time:** Explain the format pattern for date and time.
60. **Getting the current date/time without time/date:** Write a program that extracts the current date without the time or date.
61. **LocalDateTime from LocalDate and LocalTime:** Write a program that builds a `LocalDateTime` from `LocalDate` object and `LocalTime`. It combines the date and time in a single `LocalDateTime` object.
62. **Machine time via an Instant class:** Explain and give an example of the `Instant` API.
63. **Defining a period of time using date-based values (Period) and a duration of time using time-based values (Duration):** Explain and give an example of the usage of the `Period` and `Duration` APIs.

64. **Getting date and time units:** Write a program that extracts the date and time units (for example, extract from date the year, month, minute, and so on) from an object representing a date-time.
65. **Adding and subtracting to/from a date-time:** Write a program that adds (and subtracts) an amount of time (for example, years, days, or minutes) to a date-time object (for example, add an hour to date, subtract 2 days from `LocalDateTime`, and so on).
66. **Getting all time zones with UTC and GMT:** Write a program that displays all the available time zones with UTC and GMT.
67. **Getting the local date-time in all available time zones:** Write a program that displays the local time in all the available time zones.
68. **Displaying date-time information about a flight:** Write a program that displays information about a scheduled flight time of 15 hours and 30 minutes. More precisely, a flight from Perth, Australia to Bucharest, Europe.
69. **Converting a Unix timestamp to date-time:** Write a program that converts a Unix timestamp to `java.util.Date` and `java.time.LocalDateTime`.
70. **Finding the first/last day of the month:** Write a program that finds the first/last day of the month via JDK 8, `TemporalAdjusters`.
71. **Defining/extracting zone offsets:** Write a program that reveals different techniques for defining and extracting zone offsets.
72. **Converting between `Date` and `Temporal`:** Write a program that converts between `Date` and `Instant`, `LocalDate`, `LocalDateTime`, and so on.
73. **Iterating a range of dates:** Write a program that iterates a range of given dates, day by day (with a step of a day).
74. **Calculating age:** Write a program that calculates the age of a person.
75. **Start and end of a day:** Write a program that returns the start and end time of a day.
76. **Difference between two dates:** Write a program that calculates the amount of time, in days, between two dates.
77. **Implementing a chess clock:** Write a program that implements a chess clock.

Solutions

The following sections describe solutions to the preceding problems. Remember that there usually isn't a single correct way to solve a particular problem. Also, remember that the explanations shown here include only the most interesting and important details that are needed to solve the problems. Download the example solutions to see additional details and to experiment with the programs at <https://github.com/PacktPublishing/Java-Coding-Problems>.

58. Converting a string to date and time

Converting or parsing `String` to date and time can be accomplished via a set of `parse()` methods. Converting from date and time to `String` can be accomplished via the `toString()` or `format()` methods.

Before JDK 8

Before JDK 8, the typical solution to this problem relies on the main extension of the abstract `DateFormat` class, named `SimpleDateFormat` (this is not a thread-safe class). In the code that is bundled to this book, there are several examples of how to use this class.

Starting with JDK 8

Starting with JDK 8, `SimpleDateFormat` can be replaced with a new class—`DateTimeFormatter`. This is an immutable (and, therefore, thread-safe) class, and is used for printing and parsing date-time objects. This class supports everything from predefined formatters (represented as constants, as the ISO local date, 2011-12-03, is `ISO_LOCAL_DATE`) to user-defined formatters (relying on a set of symbols for writing custom format patterns).

Moreover, beside the `Date` class, JDK 8 comes with several new classes, which are dedicated to working with date and time. Some of these classes are shown in the following list (these are also referenced as temporals because they implement the `Temporal` interface):

- `LocalDate` (date without a time zone in the ISO-8601 calendar system)
- `LocalTime` (time without a time zone in the ISO-8601 calendar system)

- `LocalDateTime` (date-time without a time zone in the ISO-8601 calendar system)
- `ZonedDateTime` (date-time with a time zone in the ISO-8601 calendar system), and so on
- `OffsetDateTime` (date-time with an offset from UTC/GMT in the ISO-8601 calendar system)
- `OffsetTime` (time with an offset from UTC/GMT in the ISO-8601 calendar system)

In order to convert `String` to `LocalDate` via a predefined formatter, it should respect the `DateTimeFormatter.ISO_LOCAL_DATE` pattern, for example, 2020-06-01. `LocalDate` provides a `parse()` method that can be used as follows:

```
// 06 is the month, 01 is the day
LocalDate localDate = LocalDate.parse("2020-06-01");
```

Similarly, in the case of `LocalTime`, the string should respect the `DateTimeFormatter.ISO_LOCAL_TIME` pattern; for example, 10:15:30, as shown in the following code snippet:

```
LocalTime localTime = LocalTime.parse("12:23:44");
```

In the case of `LocalDateTime`, the string should respect the `DateTimeFormatter.ISO_LOCAL_DATE_TIME` pattern; for example, 2020-06-01T11:20:15, as shown in the following code snippet:

```
LocalDateTime localDateTime
    = LocalDateTime.parse("2020-06-01T11:20:15");
```

And, in case of `ZonedDateTime`, the string must respect the `DateTimeFormatter.ISO_ZONED_DATE_TIME` pattern; for example, 2020-06-01T10:15:30+09:00[Asia/Tokyo], as shown in the following code snippet:

```
ZonedDateTime zonedDateTime
    = ZonedDateTime.parse("2020-06-01T10:15:30+09:00[Asia/Tokyo]");
```

In the case of `OffsetDateTime`, the string must respect the `DateTimeFormatter.ISO_OFFSET_DATE_TIME` pattern; for example, 2007-12-03T10:15:30+01:00, as shown in the following code snippet:

```
OffsetDateTime offsetDateTime
    = OffsetDateTime.parse("2007-12-03T10:15:30+01:00");
```

Finally, in the case of `OffsetTime`, the string must respect the `DateTimeFormatter.ISO_OFFSET_TIME` pattern; for example, `10:15:30+01:00`, as shown in the following code snippet:

```
OffsetTime offsetTime = OffsetTime.parse("10:15:30+01:00");
```

If the string doesn't respect any of the predefined formatters, then it is time for a user-defined formatter via a custom format pattern; for example, the string `01.06.2020` represents a date that needs a user-defined formatter, as follows:

```
DateTimeFormatter dateFormatter  
    = DateTimeFormatter.ofPattern("dd.MM.yyyy");  
LocalDate localDateFormatted  
    = LocalDate.parse("01.06.2020", dateFormatter);
```

However, a string such as `12|23|44` requires a user-defined formatter as follows:

```
DateTimeFormatter timeFormatter  
    = DateTimeFormatter.ofPattern("HH|mm|ss");  
LocalTime localTimeFormatted  
    = LocalTime.parse("12|23|44", timeFormatter);
```

A string such as `01.06.2020, 11:20:15` requires a user-defined formatter as follows:

```
DateTimeFormatter dateTimeFormatter  
    = DateTimeFormatter.ofPattern("dd.MM.yyyy, HH:mm:ss");  
LocalDateTime localDateTimeFormatted  
    = LocalDateTime.parse("01.06.2020, 11:20:15", dateTimeFormatter);
```

A string such as `01.06.2020, 11:20:15+09:00 [Asia/Tokyo]` requires a user-defined formatter as follows:

```
DateTimeFormatter zonedDateTimeFormatter  
    = DateTimeFormatter.ofPattern("dd.MM.yyyy, HH:mm:ssXXXXXX '['VV']");  
ZonedDateTime zonedDateTimeFormatted  
    = ZonedDateTime.parse("01.06.2020, 11:20:15+09:00 [Asia/Tokyo]",  
        zonedDateTimeFormatter);
```

A string such as `2007.12.03, 10:15:30, +01:00` requires a user-defined formatter as follows:

```
DateTimeFormatter offsetDateTimeFormatter  
    = DateTimeFormatter.ofPattern("yyyy.MM.dd, HH:mm:ss, XXXXX");  
OffsetDateTime offsetDateTimeFormatted  
    = OffsetDateTime.parse("2007.12.03, 10:15:30, +01:00",  
        offsetDateTimeFormatter);
```

Finally, a string such as `10 15 30 +01:00` requires a user-defined formatter as follows:

```
DateTimeFormatter offsetTimeFormatter
    = DateTimeFormatter.ofPattern("HH mm ss XXXXX");
OffsetTime offsetTimeFormatted
    = OffsetTime.parse("10 15 30 +01:00", offsetTimeFormatter);
```



Each of `ofPattern()` method from the previous examples also supports `Locale`.

Converting from `LocalDate`, `LocalDateTime`, or `ZonedDateTime` to `String` can be accomplished in at least two ways:

- Rely on the `LocalDate`, `LocalDateTime`, or `ZonedDateTime.toString()` method (automatically or explicitly). Notice that relying on `toString()` will always print the date via the corresponding predefined formatter:

```
// 2020-06-01 results in ISO_LOCAL_DATE, 2020-06-01
String localDateAsString = localDate.toString();

// 01.06.2020 results in ISO_LOCAL_DATE, 2020-06-01
String localDateAsString = localDateFormatted.toString();

// 2020-06-01T11:20:15 results
// in ISO_LOCAL_DATE_TIME, 2020-06-01T11:20:15
String localDateTimeAsString = localDateTime.toString();

// 01.06.2020, 11:20:15 results in
// ISO_LOCAL_DATE_TIME, 2020-06-01T11:20:15
String localDateTimeAsString
    = localDateTimeFormatted.toString();

// 2020-06-01T10:15:30+09:00[Asia/Tokyo]
// results in ISO_ZONED_DATE_TIME,
// 2020-06-01T11:20:15+09:00[Asia/Tokyo]
String zonedDateTimeAsString = zonedDateTime.toString();

// 01.06.2020, 11:20:15+09:00 [Asia/Tokyo]
// results in ISO_ZONED_DATE_TIME,
// 2020-06-01T11:20:15+09:00[Asia/Tokyo]
String zonedDateTimeAsString
    = zonedDateTimeFormatted.toString();
```

- Rely on the `DateTimeFormatter.format()` method. Notice that relying on `DateTimeFormatter.format()` will always print the date/time using the specified formatter (by default, the time zone will be `null`), as follows:

```
// 01.06.2020
String localDateAsFormattedString
    = dateFormatter.format(localDateFormatted);

// 01.06.2020, 11:20:15
String localDateTimeAsFormattedString
    = dateTimeFormatter.format(localDateTimeFormatted);

// 01.06.2020, 11:20:15+09:00 [Asia/Tokyo]
String zonedDateTimeAsFormattedString
    = zonedDateTimeFormatted.format(zonedDateTimeFormatter);
```

Adding an explicit time zone into the discussion can be done as follows:

```
DateTimeFormatter zonedDateTimeFormatter
    = DateTimeFormatter.ofPattern("dd.MM.yyyy, HH:mm:ssXXXXX '['VV']'")
        .withZone(ZoneId.of("Europe/Paris"));
ZonedDateTime zonedDateTimeFormatted
    = ZonedDateTime.parse("01.06.2020, 11:20:15+09:00 [Asia/Tokyo]",
        zonedDateTimeFormatter);
```

This time, the string represents the date/time in the Europe/Paris time zone:

```
// 01.06.2020, 04:20:15+02:00 [Europe/Paris]
String zonedDateTimeAsFormattedString
    = zonedDateTimeFormatted.format(zonedDateTimeFormatter);
```

59. Formatting date and time

The previous problem contains some flavors of formatting date and time via `SimpleDateFormat.format()` and `DateTimeFormatter.format()`. In order to define *format patterns*, the developer must be aware of the format pattern syntax. In other words, the developer must be aware of the set of symbols that are used by the Java date-time API in order to recognize a valid format pattern.

Most of the symbols are common to `SimpleDateFormat` (before JDK 8) and to `DateTimeFormatter` (starting with JDK 8). The following table lists the most common symbols—the complete list is available in the JDK documentation:

Letter	Meaning	Presentation	Example
y	year	year	1994; 94
M	month of year	number/text	7; 07; Jul; July; J
W	week of month	number	4
E	day of week	text	Tue; Tuesday; T
d	day of month	number	15
H	hour of day	number	22
m	minute of hour	number	34
s	second of minute	number	55
S	fraction of second	number	345
z	time zone name	zone-name	Pacific Standard Time; PST
Z	zone offset	zone-offset	-0800
V	time zone id (JDK 8)	zone-id	America/Los_Angeles; Z; -08:30

Some format pattern examples are available in the following table:

Pattern	Example
yyyy-MM-dd	2019-02-24
MM-dd-yyyy	02-24-2019
MMM-dd-yyyy	Feb-24-2019
dd-MM-yy	24-02-19
dd.MM.yyyy	24.02.2019
yyyy-MM-dd HH:mm:ss	2019-02-24 11:26:26
yyyy-MM-dd HH:mm:ssSSS	2019-02-24 11:36:32743
yyyy-MM-dd HH:mm:ssZ	2019-02-24 11:40:35+0200
yyyy-MM-dd HH:mm:ss z	2019-02-24 11:45:03 EET
E MMM yyyy HH:mm:ss.SSSZ	Sun Feb 2019 11:46:32.393+0200
yyyy-MM-dd HH:mm:ss VV (JDK 8)	2019-02-24 11:45:41 Europe/Athens

Before JDK 8, a format pattern can be applied via `SimpleDateFormat`:

```
// yyyy-MM-dd
Date date = new Date();
SimpleDateFormat formatter = new SimpleDateFormat("yyyy-MM-dd");
String stringDate = formatter.format(date);
```

Starting with JDK 8, a format pattern can be applied via `DateTimeFormatter`:

- For `LocalDate` (date without a time zone in the ISO-8601 calendar system):

```
// yyyy-MM-dd
LocalDate localDate = LocalDate.now();
DateTimeFormatter formatterLocalDate
    = DateTimeFormatter.ofPattern("yyyy-MM-dd");
String stringLD = formatterLocalDate.format(localDate);

// or shortly
String stringLD = LocalDate.now()
    .format(DateTimeFormatter.ofPattern("yyyy-MM-dd"));
```

- For `LocalTime` (time without a time zone in the ISO-8601 calendar system):

```
// HH:mm:ss
LocalTime localTime = LocalTime.now();
DateTimeFormatter formatterLocalTime
    = DateTimeFormatter.ofPattern("HH:mm:ss");
String stringLT
    = formatterLocalTime.format(localTime);

// or shortly
String stringLT = LocalTime.now()
    .format(DateTimeFormatter.ofPattern("HH:mm:ss"));
```

- For `LocalDateTime` (date-time without a time zone in the ISO-8601 calendar system):

```
// yyyy-MM-dd HH:mm:ss
LocalDateTime localDateTime = LocalDateTime.now();
DateTimeFormatter formatterLocalDateTime
    = DateTimeFormatter.ofPattern("yyyy-MM-dd HH:mm:ss");
String stringLDT
    = formatterLocalDateTime.format(localDateTime);

// or shortly
String stringLDT = LocalDateTime.now()
    .format(DateTimeFormatter.ofPattern("yyyy-MM-dd HH:mm:ss"));
```

- For `ZonedDateTime` (date-time with a time zone in the ISO-8601 calendar system):

```
// E MMM yyyy HH:mm:ss.SSSZ
ZonedDateTime zonedDateTime = ZonedDateTime.now();
DateTimeFormatter formatterZonedDateTime
    = DateTimeFormatter.ofPattern("E MMM yyyy HH:mm:ss.SSSZ");
String stringZDT
    = formatterZonedDateTime.format(zonedDateTime);

// or shortly
String stringZDT = ZonedDateTime.now()
    .format(DateTimeFormatter
        .ofPattern("E MMM yyyy HH:mm:ss.SSSZ"));
```

- For `OffsetDateTime` (date-time with an offset from UTC/GMT in the ISO-8601 calendar system):

```
// E MMM yyyy HH:mm:ss.SSSZ
OffsetDateTime offsetDateTime = OffsetDateTime.now();
DateTimeFormatter formatterOffsetDateTime
    = DateTimeFormatter.ofPattern("E MMM yyyy HH:mm:ss.SSSZ");
String odt1 = formatterOffsetDateTime.format(offsetDateTime);

// or shortly
String odt2 = OffsetDateTime.now()
    .format(DateTimeFormatter
        .ofPattern("E MMM yyyy HH:mm:ss.SSSZ"));
```

- For `OffsetTime` (time with an offset from UTC/GMT in the ISO-8601 calendar system):

```
// HH:mm:ss,Z
OffsetTime offsetTime = OffsetTime.now();
DateTimeFormatter formatterOffsetTime
    = DateTimeFormatter.ofPattern("HH:mm:ss,Z");
String ot1 = formatterOffsetTime.format(offsetTime);

// or shortly
String ot2 = OffsetTime.now()
    .format(DateTimeFormatter.ofPattern("HH:mm:ss,Z"));
```

60. Getting the current date/time without time/date

Before JDK 8, the solution must focus on the `java.util.Date` class. The code that is bundled to this book contains this solution.

Starting with JDK 8, the date and time can be obtained via the dedicated classes, `LocalDate` and `LocalTime`, from the `java.time` package:

```
// 2019-02-24
LocalDate onlyDate = LocalDate.now();

// 12:53:28.812637300
LocalTime onlyTime = LocalTime.now();
```

61. LocalDateTime from LocalDate and LocalTime

The `LocalDateTime` class exposes a series of `of()` methods that are useful for obtaining a different kind of instance of `LocalDateTime`. For example, a `LocalDateTime` class that is obtained from the year, month, day, hour, minute, second, or nanosecond looks like this:

```
LocalDateTime ldt = LocalDateTime.of(2020, 4, 1, 12, 33, 21, 675);
```

So, the preceding code combines date and time as arguments of the `of()` method. In order to combine date and time as objects, the solution can take advantage of the following `of()` method:

```
public static LocalDateTime of(LocalDate date, LocalTime time)
```

This results in `LocalDate` and `LocalTime`, as in the following:

```
LocalDate localDate = LocalDate.now(); // 2019-Feb-24
LocalTime localTime = LocalTime.now(); // 02:08:10 PM
```

They can be combined in a single object, `LocalDateTime`, as follows:

```
LocalDateTime localDateTime = LocalDateTime.of(localDate, localTime);
```

Formatting `LocalDateTime` reveals the date and time as follows:

```
// 2019-Feb-24 02:08:10 PM
String localDateTimeAsString = localDateTime
    .format(DateTimeFormatter.ofPattern("yyyy-MMM-dd hh:mm:ss a"));
```

62. Machine time via an Instant class

JDK 8 comes with a new class, which is named `java.time.Instant`. Mainly, the `Instant` class represents an instantaneous point on the timeline, beginning from the first second of January 1, 1970 (the epoch), in the UTC time zone with a resolution of nanoseconds.



A Java 8 `Instant` class is similar in concept to `java.util.Date`. Both represent a moment on the timeline in UTC. While `Instant` has a resolution up to nanoseconds, `java.util.Date` has a milliseconds resolution.

This class is very handy for generating timestamps of machine time. In order to obtain such a timestamp, simply call the `now()` method as follows:

```
// 2019-02-24T15:05:21.781049600Z
Instant timestamp = Instant.now();
```

A similar output can be obtained with the following code snippet:

```
OffsetDateTime now = OffsetDateTime.now(ZoneOffset.UTC);
```

Alternatively, use this code snippet:

```
Clock clock = Clock.systemUTC();
```



Calling `Instant.toString()` produces an output that follows the ISO-8601 standard for representing date and time.

Converting String to Instant

A string that follows the ISO-8601 standard for representing date and time can be easily converted to `Instant` via the `Instant.parse()` method, as in the following example:

```
// 2019-02-24T14:31:33.197021300Z
Instant timestampFromString =
    Instant.parse("2019-02-24T14:31:33.197021300Z");
```

Adding or subtracting time to/from Instant

For adding time, `Instant` has a suite of methods. For example, adding 2 hours to the current timestamp can be accomplished as follows:

```
Instant twoHourLater = Instant.now().plus(2, ChronoUnit.HOURS);
```

In terms of subtracting time, for example, 10 minutes, use the following code snippet:

```
Instant tenMinutesEarlier = Instant.now()
    .minus(10, ChronoUnit.MINUTES);
```



Beside the `plus()` method, `Instant` also contains `plusNanos()`, `plusMillis()`, and `plusSeconds()`. Moreover, beside the `minus()` method, `Instant` also contains `minusNanos()`, `minusMillis()`, and `minusSeconds()`.

Comparing Instant objects

Comparing two `Instant` objects can be accomplished via the `Instant.isAfter()` and `Instant.isBefore()` methods. For example, let's look at the following two `Instant` objects:

```
Instant timestamp1 = Instant.now();
Instant timestamp2 = timestamp1.plusSeconds(10);
```

Check whether `timestamp1` is after `timestamp2`:

```
boolean isAfter = timestamp1.isAfter(timestamp2); // false
```

Check whether `timestamp1` is before `timestamp2`:

```
boolean isBefore = timestamp1.isBefore(timestamp2); // true
```

The time difference between two `Instant` objects can be computed via the `Instant.until()` method:

```
// 10 seconds
long difference = timestamp1.until(timestamp2, ChronoUnit.SECONDS);
```

Converting between `Instant` and `LocalDateTime`, `ZonedDateTime`, and `OffsetDateTime`

These common conversions can be accomplished as in the following examples:

- Convert between `Instant` and `LocalDateTime`—since `LocalDateTime` has no idea of time zone, use a zero offset UTC+0:

```
// 2019-02-24T15:27:13.990103700
LocalDateTime ldt = LocalDateTime.ofInstant(
    Instant.now(), ZoneOffset.UTC);

// 2019-02-24T17:27:14.013105Z
Instant instantLDT =
    LocalDateTime.now().toInstant(ZoneOffset.UTC);
```

- Convert between `Instant` and `ZonedDateTime`—convert an `Instant` UTC+0 to a Paris `ZonedDateTime` UTC+1:

```
// 2019-02-24T16:34:36.138393100+01:00[Europe/Paris]
ZonedDateTime zdt =
    Instant.now().atZone(ZoneId.of("Europe/Paris"));

// 2019-02-24T16:34:36.150393800Z
Instant instantZDT = LocalDateTime.now()
    .atZone(ZoneId.of("Europe/Paris")).toInstant();
```

- Convert between `Instant` and `OffsetDateTime`—specify an offset of 2 hours:

```
// 2019-02-24T17:34:36.151393900+02:00
OffsetDateTime odt =
    Instant.now().atOffset(ZoneOffset.of("+02:00"));

// 2019-02-24T15:34:36.153394Z
Instant instantODT = LocalDateTime.now()
    .atOffset(ZoneOffset.of("+02:00")).toInstant();
```

63. Defining a period of time using date-based values and a duration of time using time-based values

JDK 8 comes with two new classes, named `java.time.Period` and `java.time.Duration`. Let's take a detailed look at them in the next sections.

Period of time using date-based values

The `Period` class is meant to represent an amount of time using date-based values (years, months, weeks, and days). This period of time can be obtained in different ways. For example, a period of 120 days can be obtained as follows:

```
Period fromDays = Period.ofDays(120); // P120D
```



Next to the `ofDays()` method, the `Period` class also has `ofMonths()`, `ofWeeks()`, and `ofYears()`.

Or, a period of 2,000 years, 11 months and 24 days can be obtained via the `of()` method, as follows:

```
Period periodFromUnits = Period.of(2000, 11, 24); // P2000Y11M24D
```

`Period` can also be obtained from `LocalDate`:

```
LocalDate localDate = LocalDate.now();  
Period periodFromLocalDate = Period.of(localDate.getYear(),  
    localDate.getMonthValue(), localDate.getDayOfMonth());
```

Finally, `Period` can be obtained from a `String` object that respects the ISO-8601 period formats `PnYnMnD` and `PnW`. For example, the `P2019Y2M25D` string represents 2019 years, 2 months, and 25 days:

```
Period periodFromString = Period.parse("P2019Y2M25D");
```



Calling `Period.toString()` will return the period while also respecting the ISO-8601 period formats, `PnYnMnD` and `PnW` (for example, `P120D`, `P2000Y11M24D`.)]

But, the real power of `Period` is revealed when it is used to represent a period of time between two dates (for example, `LocalDate`). The period of time between March 12, 2018 and July 20, 2019 can be represented as follows:

```
LocalDate startLocalDate = LocalDate.of(2018, 3, 12);
LocalDate endLocalDate = LocalDate.of(2019, 7, 20);
Period periodBetween = Period.between(startLocalDate, endLocalDate);
```

The amount of time in years, months, and days can be obtained via `Period.getYears()`, `Period.getMonths()`, and `Period.getDays()`. For example, the following helper method uses these methods to output the amount of time as a string:

```
public static String periodToYMD(Period period) {

    StringBuilder sb = new StringBuilder();
    sb.append(period.getYears())
      .append("y:")
      .append(period.getMonths())
      .append("m:")
      .append(period.getDays())
      .append("d");

    return sb.toString();
}
```

Let's call this method `periodBetween` (the difference is 1 year, 4 months, and 8 days):

```
periodToYMD(periodBetween); // 1y:4m:8d
```

The `Period` class is also useful when determining whether a particular date is earlier than another date. There is a flag method, named `isNegative()`. Having an `A` period and a `B` period, the result of applying `Period.between(A, B)` can be negative if `B` is before `A`, or positive if `A` is before `B`. Taking this logic further, `isNegative()` returns `true` if `B` is before `A` or `false` if `A` is before `B`, as in our case that follows (basically, this method returns `false` if years, months, or days is negative):

```
// returns false, since 12 March 2018 is earlier than 20 July 2019
periodBetween.isNegative();
```

Finally, `Period` can be modified by adding or subtracting a period of time. There are methods such as `plusYears()`, `plusMonths()`, `plusDays()`, `minusYears()`, `minusMonths()`, and `minusDays()`. For example, adding 1 year to `periodBetween` can be done as follows:

```
Period periodBetweenPlus1Year = periodBetween.plusYears(1L);
```

Adding two `Period` classes can be accomplished via the `Period.plus()` method, as follows:

```
Period p1 = Period.ofDays(5);
Period p2 = Period.ofDays(20);
Period p1p2 = p1.plus(p2); // P25D
```

Duration of time using time-based values

The `Duration` class is meant to represent an amount of time using time-based values (hours, minutes, seconds, or nanoseconds). This duration of time can be obtained in different ways. For example, a duration of 10 hours can be obtained as follows:

```
Duration fromHours = Duration.ofHours(10); // PT10H
```



Next to the `ofHours()` method, the `Duration` class also has `ofDays()`, `ofMillis()`, `ofMinutes()`, `ofSeconds()`, and `ofNanos()`.

Alternatively, a duration of 3 minutes can be obtained via the `of()` method, as follows:

```
Duration fromMinutes = Duration.of(3, ChronoUnit.MINUTES); // PT3M
```

`Duration` can also be obtained from `LocalDateTime`:

```
LocalDateTime localDateTime
    = LocalDateTime.of(2018, 3, 12, 4, 14, 20, 670);

// PT14M
Duration fromLocalDateTime
    = Duration.ofMinutes(localDateTime.getMinute());
```

It can also be obtained from `LocalTime`:

```
LocalTime localTime = LocalTime.of(4, 14, 20, 670);

// PT0.00000067S
Duration fromLocalTime = Duration.ofNanos(localTime.getNano());
```

Finally, `Duration` can be obtained from a `String` object that respects the ISO-8601 duration format `PnDTnHnMn.nS`, with days considered to be exactly 24 hours. For example, the `P2DT3H4M` string has 2 days, 3 hours, and 4 minutes:

```
Duration durationFromString = Duration.parse("P2DT3H4M");
```



Calling `Duration.toString()` will return the duration that respects the ISO-8601 duration format, `PnDTnHnMn.nS` (for example, `PT10H`, `PT3M`, or `PT51H4M`).

But, as in the case of `Period`, the real power of `Duration` is revealed when it is used to represent a period of time between two times (for example, `Instant`). The duration of time between November 3, 2015, 12:11:30, and December 6, 2016, 15:17:10, can be represented as the difference between two `Instant` classes, as follows:

```
Instant startInstant = Instant.parse("2015-11-03T12:11:30.00Z");
Instant endInstant = Instant.parse("2016-12-06T15:17:10.00Z");

// PT10059H5M40S
Duration durationBetweenInstant
    = Duration.between(startInstant, endInstant);
```

In seconds, this difference can be obtained via the `Duration.getSeconds()` method:

```
durationBetweenInstant.getSeconds(); // 36212740 seconds
```

Or, the duration of time between March 12, 2018, 04:14:20.000000670 and July 20, 2019, 06:10:10.000000720, can be represented as the difference between two `LocalDateTime` objects, as follows:

```
LocalDateTime startLocalDateTime
    = LocalDateTime.of(2018, 3, 12, 4, 14, 20, 670);
LocalDateTime endLocalDateTime
    = LocalDateTime.of(2019, 7, 20, 6, 10, 10, 720);
// PT11881H55M50.00000005S, or 42774950 seconds
Duration durationBetweenLDT
    = Duration.between(startLocalDateTime, endLocalDateTime);
```

Finally, the duration of time between 04:14:20.000000670 and 06:10:10.000000720, can be represented as the difference between two `LocalTime` objects, as follows:

```
LocalTime startLocalTime = LocalTime.of(4, 14, 20, 670);
LocalTime endLocalTime = LocalTime.of(6, 10, 10, 720);

// PT1H55M50.00000005S, or 6950 seconds
Duration durationBetweenLT
    = Duration.between(startLocalTime, endLocalTime);
```

In the preceding examples, `Duration` was expressed in seconds via the `Duration.getSeconds()` method—this is the number of seconds in the `Duration` class. However, the `Duration` class contains a set of methods that are dedicated to expressing `Duration` in other time units—in days via `toDays()`, in hours via `toHours()`, in minutes via `toMinutes()`, in milliseconds via `toMillis()`, and in nanoseconds via `toNanos()`.

Converting from one unit of time to another unit of time may result in a remnant. For example, converting from seconds to minutes may result in a remnant of seconds (for example, 65 seconds is 1 minute and 5 seconds (5 seconds is the remnant)). The remnant can be obtained via the following set of methods—the remnant in days via `toDaysPart()`, the remnant in hours via `toHoursPart()`, the remnant in minutes via `toMinutesPart()`, and so on.

Let's assume that the difference should be displayed as days:hours:minutes:seconds:nano (for example, 9d:2h:15m:20s:230n). Joining the forces of the `toFoo()` and `toFooPart()` methods in a helper method will result in the following code:

```
public static String durationToDHMSN(Duration duration) {

    StringBuilder sb = new StringBuilder();
    sb.append(duration.toDays())
      .append("d:")
      .append(duration.toHoursPart())
      .append("h:")
      .append(duration.toMinutesPart())
      .append("m:")
      .append(duration.toSecondsPart())
      .append("s:")
      .append(duration.toNanosPart())
      .append("n");

    return sb.toString();
}
```

Let's call this method `durationBetweenLDT` (the difference is 495 days, 1 hour, 55 minutes, 50 seconds, and 50 nanoseconds):

```
// 495d:1h:55m:50s:50n
durationToDHMSN(durationBetweenLDT);
```

Identical to the `Period` class, the `Duration` class has a flag method named `isNegative()`. This method is useful when determining whether a particular time is earlier than another time. Having duration `A` and duration `B`, the result of applying `Duration.between(A, B)` can be negative if `B` is before `A`, or positive if `A` is before `B`. Taking the logic further, `isNegative()` returns `true` if `B` is before `A`, or `false` if `A` is before `B`, as in the following case:

```
durationBetweenLT.isNegative(); // false
```

Finally, `Duration` can be modified by adding or subtracting a duration of time. There are methods such as `plusDays()`, `plusHours()`, `plusMinutes()`, `plusMillis()`, `plusNanos()`, `minusDays()`, `minusHours()`, `minusMinutes()`, `minusMillis()`, and `minusNanos()` to perform this. For example, adding 5 hours to `durationBetweenLT` can be done as follows:

```
Duration durationBetweenPlus5Hours = durationBetweenLT.plusHours(5);
```

Adding two `Duration` classes can be accomplished via the `Duration.plus()` method, as follows:

```
Duration d1 = Duration.ofMinutes(20);
Duration d2 = Duration.ofHours(2);

Duration d1d2 = d1.plus(d2);

System.out.println(d1 + "+" + d2 + "=" + d1d2); // PT2H20M
```

64. Getting date and time units

For a `Date` object, the solution may rely on a `Calendar` instance. The code that is bundled to this book contains this solution.

For JDK 8 classes, Java provides dedicated `getFoo()` methods and a `get(TemporalField field)` method. For example, let's assume the following `LocalDateTime` object:

```
LocalDateTime ldt = LocalDateTime.now();
```

Relying on `getFoo()` methods, we get the following code:

```
int year = ldt.getYear();
int month = ldt.getMonthValue();
int day = ldt.getDayOfMonth();
int hour = ldt.getHour();
int minute = ldt.getMinute();
int second = ldt.getSecond();
int nano = ldt.getNano();
```

Or, relying on `get(TemporalField field)` results in the following:

```
int yearLDT = ldt.get(ChronoField.YEAR);
int monthLDT = ldt.get(ChronoField.MONTH_OF_YEAR);
int dayLDT = ldt.get(ChronoField.DAY_OF_MONTH);
int hourLDT = ldt.get(ChronoField.HOUR_OF_DAY);
int minuteLDT = ldt.get(ChronoField.MINUTE_OF_HOUR);
int secondLDT = ldt.get(ChronoField.SECOND_OF_MINUTE);
int nanoLDT = ldt.get(ChronoField.NANO_OF_SECOND);
```

Notice that the months are counted from one, which is January.

For example, a `LocalDateTime` object of `2019-02-25T12:58:13.109389100` can be cut into date-time units, resulting in the following:

```
Year: 2019 Month: 2 Day: 25 Hour: 12 Minute: 58 Second: 13 Nano:
109389100
```

With a little intuition and documentation, it is very easy to adapt this example for `LocalDate`, `LocalTime`, `ZonedDateTime`, and others.

65. Adding and subtracting to/from date-time

The solution to this problem relies on the Java APIs that are dedicated to manipulating date and time. Let's take a look at them in the next sections.

Working with Date

For a `Date` object, the solution may rely on a `Calendar` instance. The code that is bundled to this book contains this solution.

Working with LocalDateTime

Jumping to JDK 8, the focus is on `LocalDate`, `LocalTime`, `LocalDateTime`, `Instant`, and many more. The new Java date-time API comes with methods that are dedicated to adding or subtracting an amount of time. `LocalDate`, `LocalTime`, `LocalDateTime`, `ZonedDateTime`, `OffsetDateTime`, `Instant`, `Period`, `Duration`, and many others come with methods such as `plusFoo()` and `minusFoo()`, where `Foo` can be replaced with the unit of time (for example, `plusYears()`, `plusMinutes()`, `minusHours()`, `minusSeconds()`, and so on).

Let's assume the following `LocalDateTime`:

```
// 2019-02-25T14:55:06.651155500
LocalDateTime ldt = LocalDateTime.now();
```

Adding 10 minutes is as easy as calling `LocalDateTime.plusMinutes(long minutes)`, while subtracting 10 minutes is as easy as calling `LocalDateTime.minusMinutes(long minutes)`:

```
LocalDateTime ldtAfterAddingMinutes = ldt.plusMinutes(10);
LocalDateTime ldtAfterSubtractingMinutes = ldt.minusMinutes(10);
```

The output will reveal the following dates:

```
After adding 10 minutes: 2019-02-25T15:05:06.651155500
After subtracting 10 minutes: 2019-02-25T14:45:06.651155500
```



Beside the methods dedicated per time unit, these classes also support `plus/minus(TemporalAmount amountToAdd)` and `plus/minus(long amountToAdd, TemporalUnit unit)`.

Now, let's focus on the `Instant` class. Besides `plus/minusSeconds()`, `plus/minusMillis()`, and `plus/minusNanos()`, the `Instant` class also provides a `plus/minus(TemporalAmount amountToAdd)` method.

In order to exemplify this method, let's assume the following `Instant`:

```
// 2019-02-25T12:55:06.654155700Z
Instant timestamp = Instant.now();
```

Now, let's add and subtract 5 hours:

```
Instant timestampAfterAddingHours
    = timestamp.plus(5, ChronoUnit.HOURS);
Instant timestampAfterSubtractingHours
    = timestamp.minus(5, ChronoUnit.HOURS);
```

The output will reveal the following `Instant`:

```
After adding 5 hours: 2019-02-25T17:55:06.654155700Z
After subtracting 5 hours: 2019-02-25T07:55:06.654155700Z
```

66. Getting all time zones with UTC and GMT

UTC and GMT are recognized as the standard references for dealing with dates and times. Today, UTC is the preferred way to go, but UTC and GMT should return the same result in most cases.

In order to get all the time zones with UTC and GMT, the solution should focus on the implementation before and after JDK 8. So, let's start with the solution that was useful before JDK 8.

Before JDK 8

The solution needs to extract the available time zone IDs (Africa/Bamako, Europe/Belgrade, and so on). Furthermore, each time zone ID should be used to create a `TimeZone` object. Finally, the solution needs to extract the offset that was specific to each time zone, taking into account Daylight Saving Time. The code that is bundled to this book contains this solution.

Starting with JDK 8

The new Java date-time API provides new leverages for solving this problem.

At the first step, the available time zones IDs can be obtained via the `ZoneId` class, as follows:

```
Set<String> zoneIds = ZoneId.getAvailableZoneIds();
```

At the second step, each time zone ID should be used to create a `ZoneId` instance. This can be accomplished via the `ZoneId.of(String zoneId)` method:

```
ZoneId zoneid = ZoneId.of(current_zone_Id);
```

At the third step, each `ZoneId` can be used to obtain the time that is specific to the identified zone. This means that a "lab rats" reference date-time is needed. This reference date-time (without a time zone, `LocalDateTime.now()`) is combined with the given time zone (`ZoneId`), via `LocalDateTime.atZone()`, in order to obtain `ZonedDateTime` (a date-time that is time-zone aware):

```
LocalDateTime now = LocalDateTime.now();
ZonedDateTime zdt = now.atZone(ZoneId.of(zone_id_instance));
```



The `atZone()` method matches the date-time as closely as possible, taking into account time zone rules, such as Daylight Saving Time.

At the fourth step, the code can exploit `ZonedDateTime` in order to extract the UTC offset (for example, for Europe/Bucharest the UTC offset is +02:00):

```
String utcOffset = zdt.getOffset().getId().replace("Z", "+00:00");
```

The `getId()` method returns the normalized zone offset ID. The +00:00 offset is returned as the Z character; therefore the code needs to quickly replace Z with +00:00, in order to align with the rest of the offsets, which respect the format +hh:mm or +hh:mm:ss.

Now, let's join these steps into a helper method:

```
public static List<String> fetchTimeZones(OffsetType type) {
    List<String> timezones = new ArrayList<>();
    Set<String> zoneIds = ZoneId.getAvailableZoneIds();
    LocalDateTime now = LocalDateTime.now();

    zoneIds.forEach((zoneId) -> {
        timezones.add("(" + type + now.atZone(ZoneId.of(zoneId))
            .getOffset().getId().replace("Z", "+00:00") + ") " + zoneId);
    });
}
```

```
    return timezones;
}
```

Assuming that this method lives in a `DateTimes` class, the following code is obtained:

```
List<String> timezones
    = DateTimes.fetchTimeZones(DateTimes.OffsetType.GMT);
Collections.sort(timezones); // optional sort
timezones.forEach(System.out::println);
```

In addition, an output snapshot is shown, as follows:

```
(GMT+00:00) Africa/Abidjan
(GMT+00:00) Africa/Accra
(GMT+00:00) Africa/Bamako
...
(GMT+11:00) Australia/Tasmania
(GMT+11:00) Australia/Victoria
...
```

67. Getting local date-time in all available time zones

The solution to this problem can be obtained by following these steps:

1. Get the local date-time.
2. Get the available time zones.
3. Before JDK 8, use `SimpleDateFormat` with the `setTimeZone()` method.
4. Starting with JDK 8, use `ZonedDateTime`.

Before JDK 8

Before JDK 8, the quick solution to get the current local date-time was to call the `Date` empty constructor. Furthermore, use `Date` to display it in all the available time zones, which can be obtained via the `TimeZone` class. The code that is bundled to this book contains this solution.

Starting with JDK 8

Starting with JDK 8, a convenient solution to get the current local date-time in the default time zone is to call the `ZonedDateTime.now()` method:

```
ZonedDateTime zlt = ZonedDateTime.now();
```

So, this is the current date in the default time zone. Furthermore, this date should be displayed in all the available time zones that are obtained via the `ZoneId` class:

```
Set<String> zoneIds = ZoneId.getAvailableZoneIds();
```

Finally, the code can loop the `zoneIds`, and for each zone id, it can call the `ZonedDateTime.withZoneSameInstant(ZoneId zone)` method. This method returns a copy of this date-time with a different time zone, retaining the instant:

```
public static List<String> localTimeToAllTimeZones() {  
  
    List<String> result = new ArrayList<>();  
    Set<String> zoneIds = ZoneId.getAvailableZoneIds();  
    DateTimeFormatter formatter  
        = DateTimeFormatter.ofPattern("yyyy-MM-dd'T'HH:mm:ss a Z");  
    ZonedDateTime zlt = ZonedDateTime.now();  
  
    zoneIds.forEach((zoneId) -> {  
        result.add(zlt.format(formatter) + " in " + zoneId + " is "  
            + zlt.withZoneSameInstant(ZoneId.of(zoneId))  
                .format(formatter));  
    });  
  
    return result;  
}
```

An output snapshot of this method can be as follows:

```
2019-Feb-26T14:26:30 PM +0200 in Africa/Nairobi  
is 2019-Feb-26T15:26:30 PM +0300  
2019-Feb-26T14:26:30 PM +0200 in America/Marigot  
is 2019-Feb-26T08:26:30 AM -0400  
...  
2019-Feb-26T14:26:30 PM +0200 in Pacific/Samoa  
is 2019-Feb-26T01:26:30 AM -1100
```

68. Displaying date-time information about a flight

The solution that is presented in this section will display the following information about the 15 hours and 30 minutes flight from Perth, Australia to Bucharest, Europe:

- UTC date-time at departure and arrival
- Perth date-time at departure and arrival in Bucharest
- Bucharest date-time at departure and arrival

Let's assume that the reference departure date-time from Perth is February 26, 2019, at 16:00 (or 4:00 PM):

```
LocalDateTime ldt = LocalDateTime.of(
    2019, Month.FEBRUARY, 26, 16, 00);
```

First, let's combine this date-time with the time zone of Australia/Perth (+08:00). This will result in a `ZonedDateTime` object that is specific to Australia/Perth (this is the clock date and time in Perth at departure):

```
// 04:00 PM, Feb 26, 2019 +0800 Australia/Perth
ZonedDateTime auPerthDepart
    = ldt.atZone(ZoneId.of("Australia/Perth"));
```

Further, let's add 15 hours and 30 minutes to `ZonedDateTime`. The resulting `ZonedDateTime` represents the date-time in Perth (this is the clock date and time in Perth on arrival in Bucharest):

```
// 07:30 AM, Feb 27, 2019 +0800 Australia/Perth
ZonedDateTime auPerthArrive
    = auPerthDepart.plusHours(15).plusMinutes(30);
```

Now, let's calculate the date-time in Bucharest at the departure date-time in Perth. Basically, the following code expresses the departure date-time from the Perth time zone in the Bucharest time zone:

```
// 10:00 AM, Feb 26, 2019 +0200 Europe/Bucharest
ZonedDateTime euBucharestDepart
    = auPerthDepart.withZoneSameInstant(ZoneId.of("Europe/Bucharest"));
```

Finally, let's calculate the date-time in Bucharest on arrival. The following code expresses the arrival date-time from the Perth time zone in the Bucharest time zone:

```
// 01:30 AM, Feb 27, 2019 +0200 Europe/Bucharest
ZonedDateTime euBucharestArrive
    = auPerthArrive.withZoneSameInstant (ZoneId.of ("Europe/Bucharest"));
```

As shown in the following figure, the UTC time at departure from Perth is 8:00 AM, while the UTC time on arrival in Bucharest is 11:30 PM:

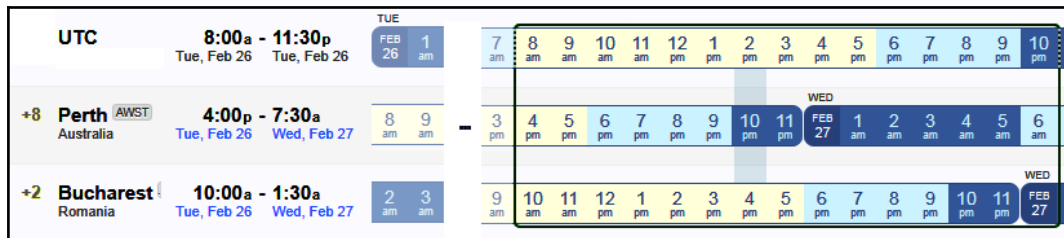

These times can be easily extracted as `OffsetDateTime`, as follows:

```
// 08:00 AM, Feb 26, 2019
OffsetDateTime utcAtDepart = auPerthDepart.withZoneSameInstant (
    ZoneId.of ("UTC")).toOffsetDateTime ();

// 11:30 PM, Feb 26, 2019
OffsetDateTime utcAtArrive = auPerthArrive.withZoneSameInstant (
    ZoneId.of ("UTC")).toOffsetDateTime ();
```

69. Converting a Unix timestamp to date-time

For this solution, let's suppose the following Unix timestamp—1573768800. This timestamp is equivalent to the following:

- 11/14/2019 @ 10:00pm (UTC)
- 2019-11-14T22:00:00+00:00 in ISO-8601
- Thu, 14 Nov 2019 22:00:00 +0000 in RFC 822, 1036, 1123, 2822
- Thursday, 14-Nov-19 22:00:00 UTC in RFC 2822
- 2019-11-14T22:00:00+00:00 in RFC 3339

In order to convert a Unix timestamp to a date-time, it is important to know that the Unix timestamps resolution is in seconds, while `java.util.Date` needs milliseconds. So, the solution to obtain a `Date` object from a Unix timestamp requires a conversion from seconds to milliseconds by multiplying the Unix timestamp by 1,000 as shown in the following two examples:

```
long unixTimestamp = 1573768800;

// Fri Nov 15 00:00:00 EET 2019 - in the default time zone
Date date = new Date(unixTimestamp * 1000L);

// Fri Nov 15 00:00:00 EET 2019 - in the default time zone
Date date = new Date(TimeUnit.MILLISECONDS
    .convert(unixTimestamp, TimeUnit.SECONDS));
```

Starting with JDK 8, the `Date` class uses the `from(Instant instant)` method. Moreover, the `Instant` class comes with the `ofEpochSecond(long epochSecond)` method, which returns an instance of `Instant`, using the given seconds from the epoch, of 1970-01-01T00:00:00Z:

```
// 2019-11-14T22:00:00Z in UTC
Instant instant = Instant.ofEpochSecond(unixTimestamp);

// Fri Nov 15 00:00:00 EET 2019 - in the default time zone
Date date = Date.from(instant);
```

The instant that was obtained in the previous example can be used to create `LocalDateTime` or `ZonedDateTime`, as follows:

```
// 2019-11-15T06:00
LocalDateTime date = LocalDateTime
    .ofInstant(instant, ZoneId.of("Australia/Perth"));

// 2019-Nov-15 00:00:00 +0200 Europe/Bucharest
ZonedDateTime date = ZonedDateTime
    .ofInstant(instant, ZoneId.of("Europe/Bucharest"));
```

70. Finding the first/last day of the month

The proper solution to this problem will rely on JDK 8's, `Temporal` and `TemporalAdjuster` interfaces.

The `Temporal` interface sits behind representations of date-time. In other words, classes that represent a date and/or a time implement this interface. For example, the following classes are just a few that implement this interface:

- `LocalDate` (date without a time zone in the ISO-8601 calendar system)
- `LocalTime` (time without a time zone in the ISO-8601 calendar system)
- `LocalDateTime` (date-time without a time zone in the ISO-8601 calendar system)
- `ZonedDateTime` (date-time with a time zone in the ISO-8601 calendar system), and so on
- `OffsetDateTime` (date-time with an offset from UTC/Greenwich in the ISO-8601 calendar system)
- `HijrahDate` (date in the Hijrah calendar system)

The `TemporalAdjuster` class is a functional interface that defines strategies that can be used to adjust a `Temporal` object. Beside the possibility of defining custom strategies, the `TemporalAdjuster` class provides several predefined strategies, as follows (the documentation contains the entire list, which is pretty impressive):

- `firstDayOfMonth()` (return the first day of the current month)
- `lastDayOfMonth()` (return the last day of the current month)
- `firstDayOfNextMonth()` (return the first day of the next month)
- `firstDayOfNextYear()` (return the first day of the next year)

Notice that the first two adjusters in the preceding list are exactly the ones needed by this problem.

Consider a fix—`LocalDate`:

```
LocalDate date = LocalDate.of(2019, Month.FEBRUARY, 27);
```

And, let's see when the first/last days of February are:

```
// 2019-02-01
LocalDate firstDayOfFeb
    = date.with(TemporalAdjusters.firstDayOfMonth());

// 2019-02-28
LocalDate lastDayOfFeb
    = date.with(TemporalAdjusters.lastDayOfMonth());
```

Looks like relying on the predefined strategies is pretty simple. But, let's assume that the problem requests you to find the date that's 21 days after February, 27 2019, which is March 20, 2019. For this problem there is no predefined strategy, therefore a custom strategy is needed. A solution to this problem can rely on a lambda expression, as in the following helper method:

```
public static LocalDate getDayAfterDays(
    LocalDate startDate, int days) {

    Period period = Period.ofDays(days);
    TemporalAdjuster ta = p -> p.plus(period);
    LocalDate endDate = startDate.with(ta);

    return endDate;
}
```

If this method lives in a class named `DateTimes`, then the following call will return the expected result:

```
// 2019-03-20
LocalDate datePlus21Days = DateTimes.getDayAfterDays(date, 21);
```

Following the same technique, but relying on the `static` factory method `ofDateAdjuster()`, the following snippet of code defines a static adjuster that returns the next date that falls on a Saturday:

```
static TemporalAdjuster NEXT_SATURDAY
    = TemporalAdjusters.ofDateAdjuster(today -> {

    DayOfWeek dayOfWeek = today.getDayOfWeek();

    if (dayOfWeek == DayOfWeek.SATURDAY) {
        return today;
    }

    if (dayOfWeek == DayOfWeek.SUNDAY) {
        return today.plusDays(6);
    }

    return today.plusDays(6 - dayOfWeek.getValue());
});
```

Let's call this method for February 27, 2019 (the next Saturday is on March 2, 2019):

```
// 2019-03-02
LocalDate nextSaturday = date.with(NEXT_SATURDAY);
```

Finally, this functional interface defines an abstract method named `adjustInto()`. This method can be overridden in custom implementations by passing a `Temporal` object to it, as follows:

```
public class NextSaturdayAdjuster implements TemporalAdjuster {

    @Override
    public Temporal adjustInto(Temporal temporal) {

        DayOfWeek dayOfWeek = DayOfWeek
            .of(temporal.get(ChronoField.DAY_OF_WEEK));

        if (dayOfWeek == DayOfWeek.SATURDAY) {
            return temporal;
        }

        if (dayOfWeek == DayOfWeek.SUNDAY) {
            return temporal.plus(6, ChronoUnit.DAYS);
        }

        return temporal.plus(6 - dayOfWeek.getValue(), ChronoUnit.DAYS);
    }
}
```

Here is the usage example:

```
NextSaturdayAdjuster nsa = new NextSaturdayAdjuster();

// 2019-03-02
LocalDate nextSaturday = date.with(nsa);
```

71. Defining/extracting zone offsets

By *zone offset*, we understand the amount of time needed to be added/subtracted from the GMT/UTC time in order to obtain the date-time for a specific zone on the globe (for example, Perth, Australia). Commonly, a zone offset is printed as a fixed number of hour and minutes: `+02:00`, `-08:30`, `+0400`, `UTC+01:00`, and so on.

So, in short, a zone offset is the amount of time by which a time zone differs from GMT/UTC.

Before JDK 8

Before JDK 8, a time zone can be defined via `java.util.TimeZone`. With this time zone, the code can obtain the zone offset via the `TimeZone.getRawOffset()` method (the *raw* part comes from the fact that this method doesn't take into account Daylight Saving Time). The code that is bundled to this book contains this solution.

Starting with JDK 8

Starting with JDK 8, there are two classes responsible for dealing with time zone representations. First, there is `java.time.ZoneId`, which represents a time zone such as Athens, Europe, and second there is `java.time.ZoneOffset` (extends `ZoneId`), which represents the fixed amount of time (offset) of the specified time zone with GMT/UTC.

The new Java date-time API deals with Daylight Saving Time by default; therefore, a region with summer-winter cycles that uses Daylight Saving Time will have two `ZoneOffset` classes.

The UTC zone offset can be easily obtained as follows (this is +00:00, represented in Java by the `Z` character):

```
// Z
ZoneOffset zoneOffsetUTC = ZoneOffset.UTC;
```

The system default time zone can also be obtained via the `ZoneOffset` class:

```
// Europe/Athens
ZoneId defaultZoneId = ZoneOffset.systemDefault();
```

In order to take the zone offset with Daylight Saving Time, the code needs to associate a date-time with it. For example, associate a `LocalDateTime` class (`Instant` can also be used) like this:

```
// by default it deals with the Daylight Saving Times
LocalDateTime ldt = LocalDateTime.of(2019, 6, 15, 0, 0);
ZoneId zoneId = ZoneId.of("Europe/Bucharest");

// +03:00
ZoneOffset zoneOffset = zoneId.getRules().getOffset(ldt);
```

A zone offset can also be obtained from a string. For example, the following code obtains a zone offset of +02:00:

```
ZoneOffset zoneOffsetFromString = ZoneOffset.of("+02:00");
```

This is a very convenient approach of quickly adding a zone offset to a `Temporal` object that supports zone offsets. For example, use it to add a zone offset to `OffsetTime` and `OffsetDateTime` (convenient ways for storing a date in a database, or sending over the wires):

```
OffsetTime offsetTime = OffsetTime.now(zoneOffsetFromString);
OffsetDateTime offsetDateTime
    = OffsetDateTime.now(zoneOffsetFromString);
```

Another solution to our problem is to rely on defining `ZoneOffset` from hours, minutes, and seconds. One of the helper methods of `ZoneOffset` is dedicated to this:

```
// +08:30 (this was obtained from 8 hours and 30 minutes)
ZoneOffset zoneOffsetFromHoursMinutes
    = ZoneOffset.ofHoursMinutes(8, 30);
```



Next to `ZoneOffset.ofHoursMinutes()`, there is `ZoneOffset.ofHours()`, `ofHoursMinutesSeconds()` and `ofTotalSeconds()`.

Finally, every `Temporal` object that supports a zone offset provides a handy `getOffset()` method. For example, the following code gets the zone offset from the preceding `offsetDateTime` object:

```
// +02:00
ZoneOffset zoneOffsetFromOdt = offsetDateTime.getOffset();
```

72. Converting between Date and Temporal

The solution that is presented here will cover the following `Temporal` classes—`Instant`, `LocalDate`, `LocalDateTime`, `ZonedDateTime`, `OffsetDateTime`, `LocalTime`, and `OffsetTime`.

Date – Instant

In order to convert from `Date` to `Instant`, the solution can rely on the `Date.toInstant()` method. The reverse can be accomplished via the `Date.from(Instant instant)` method:

- `Date` to `Instant` can be accomplished like this:

```
Date date = new Date();  
  
// e.g., 2019-02-27T12:02:49.369Z, UTC  
Instant instantFromDate = date.toInstant();
```

- `Instant` to `Date` can be accomplished like this:

```
Instant instant = Instant.now();  
  
// Wed Feb 27 14:02:49 EET 2019, default system time zone  
Date dateFromInstant = Date.from(instant);
```



Keep in mind that `Date` is not time-zone aware, but it is displayed in the system default time zone (for example, via `toString()`). `Instant` is with a UTC time zone.

Let's quickly wrap these snippets of code in two utility methods, defined in a utility class—`DateConverters`:

```
public static Instant dateToInstant(Date date) {  
    return date.toInstant();  
}  
  
public static Date instantToDate(Instant instant) {  
    return Date.from(instant);  
}
```

Further, let's enrich this class with the methods from the following screenshot:

▣	DEFAULT_TIME_ZONE	ZoneId
⊕	dateToInstant (Date date)	Instant
⊕	dateToLocalDate (Date date)	LocalDate
⊕	dateToLocalDateTime (Date date)	LocalDateTime
⊕	dateToLocalTime (Date date)	LocalTime
⊕	dateToOffsetDateTime (Date date)	OffsetDateTime
⊕	dateToOffsetTime (Date date)	OffsetTime
⊕	dateToZonedDateTime (Date date)	ZonedDateTime
⊕	instantToDate (Instant instant)	Date
⊕	localDateTimeToDate (LocalDateTime localDateTime)	Date
⊕	localDateToDate (LocalDate localDate)	Date
⊕	localTimeToDate (LocalTime localTime)	Date
⊕	offsetDateTimeToDate (OffsetDateTime offsetDateTime)	Date
⊕	offsetTimeToDate (OffsetTime offsetTime)	Date
⊕	zonedDateTimeToDate (ZonedDateTime zonedDateTime)	Date
⚙	class	

The constant from the screenshot, `DEFAULT_TIME_ZONE`, is the system default time zone:

```
public static final ZoneId DEFAULT_TIME_ZONE = ZoneId.systemDefault();
```

Date – LocalDate

A `Date` object can be converted to `LocalDate` via an `Instant` object. Once we have obtained the `Instant` object from the given `Date` object, the solution can apply to it the system default time zone, and call the `toLocalDate()` method:

```
// e.g., 2019-03-01
public static LocalDate dateToLocalDate(Date date) {
    return dateToInstant(date).atZone(DEFAULT_TIME_ZONE).toLocalDate();
}
```

Converting from `LocalDate` to `Date` should take into account that `LocalDate` doesn't contain a time component as `Date`, so the solution must supply a time component as the start of the day (more details regarding this can be found in the *Start and end of a day* problem):

```
// e.g., Fri Mar 01 00:00:00 EET 2019
public static Date localDateToDate(LocalDate localDate) {
    return Date.from(localDate.atStartOfDay(
```

```
        DEFAULT_TIME_ZONE).toInstant());  
    }
```

Date – DateLocalTime

Converting from `Date` to `DateLocalTime` is the same as converting from `Date` to `LocalDate`, apart from the fact that the solution should call the `toLocalDateTime()` method as follows:

```
// e.g., 2019-03-01T07:25:25.624  
public static LocalDateTime dateToLocalDateTime(Date date) {  
  
    return dateToInstant(date).atZone(  
        DEFAULT_TIME_ZONE).toLocalDateTime();  
}
```

Converting from `LocalDateTime` to `Date` is straightforward. Just apply the system default time zone and call `toInstant()`:

```
// e.g., Fri Mar 01 07:25:25 EET 2019  
public static Date localDateTimeToDate(LocalDateTime localDateTime) {  
  
    return Date.from(localDateTime.atZone(  
        DEFAULT_TIME_ZONE).toInstant());  
}
```

Date – ZonedDateTime

Converting `Date` to `ZonedDateTime` can be accomplished via the `Instant` object obtained from the given `Date` object and the system default time zone:

```
// e.g., 2019-03-01T07:25:25.624+02:00[Europe/Athens]  
public static ZonedDateTime dateToZonedDateTime(Date date) {  
  
    return dateToInstant(date).atZone(DEFAULT_TIME_ZONE);  
}
```

Converting `ZonedDateTime` to `Date` is just about converting `ZonedDateTime` to `Instant`:

```
// e.g., Fri Mar 01 07:25:25 EET 2019  
public static Date zonedDateTimeToDate(ZonedDateTime zonedDateTime) {  
  
    return Date.from(zonedDateTime.toInstant());  
}
```

Date – OffsetDateTime

Converting from `Date` to `OffsetDateTime` relies on the `toOffsetDateTime()` method:

```
// e.g., 2019-03-01T07:25:25.624+02:00
public static OffsetDateTime dateToOffsetDateTime(Date date) {

    return dateToInstant(date).atZone(
        DEFAULT_TIME_ZONE).toOffsetDateTime();
}
```

An approach for converting from `OffsetDateTime` to `Date` requires two steps. First, convert `OffsetDateTime` to `LocalDateTime`. Second, convert `LocalDateTime` to `Instant` with the corresponding offset:

```
// e.g., Fri Mar 01 07:55:49 EET 2019
public static Date offsetDateTimeToDate(
    OffsetDateTime offsetDateTime) {

    return Date.from(offsetDateTime.toLocalDateTime()
        .toInstant(ZoneOffset.of(offsetDateTime.getOffset().getId())));
}
```

Date – LocalTime

Converting `Date` to `LocalTime` can rely on the `LocalTime.toInstant()` method as follows:

```
// e.g., 08:03:20.336
public static LocalTime dateToLocalTime(Date date) {

    return LocalTime.ofInstant(dateToInstant(date), DEFAULT_TIME_ZONE);
}
```

Converting `LocalTime` to `Date` should take into account that `LocalTime` doesn't have a date component. This means that the solution should set the date on January 1, 1970, the epoch:

```
// e.g., Thu Jan 01 08:03:20 EET 1970
public static Date localTimeToDate(LocalTime localTime) {

    return Date.from(localTime.atDate(LocalDate.EPOCH)
        .toInstant(DEFAULT_TIME_ZONE.getRules()
            .getOffset(Instant.now())));
}
```

Date – OffsetTime

Converting `Date` to `OffsetTime` can rely on the `OffsetTime.toInstant()` method as follows:

```
// e.g., 08:03:20.336+02:00
public static OffsetTime dateToOffsetTime(Date date) {

    return OffsetTime.ofInstant(dateToInstant(date), DEFAULT_TIME_ZONE);
}
```

Converting `OffsetTime` to `Date` should take into account that `OffsetTime` doesn't have a date component. This means that the solution should set the date at January 1, 1970, the epoch:

```
// e.g., Thu Jan 01 08:03:20 EET 1970
public static Date offsetTimeToDate(OffsetTime offsetTime) {

    return Date.from(offsetTime.atDate(LocalDate.EPOCH).toInstant());
}
```

73. Iterating a range of dates

Let's assume that the range is demarcated by the start date, 2019 Feb 1, and the end date, 2019 Feb 21. The solution to this problem should loop the [2019 Feb 1, 2019 Feb 21) interval with a step of a day and print each date on the screen. Basically, there are two main problems to solve:

- Stop looping once the start date is equal with the end date.
- Increase the start date day by day until the end date.

Before JDK 8

Before JDK 8, the solution can rely on the `Calendar` utility class. The code that is bundled to this book contains this solution.

Starting with JDK 8

First, starting with JDK 8, the dates can be easily defined as `LocalDate`, without the help of `Calendar`:

```
LocalDate startLocalDate = LocalDate.of(2019, 2, 1);
LocalDate endLocalDate = LocalDate.of(2019, 2, 21);
```

Once the start date is equal with the end date, we stop the loop via the `LocalDate.isBefore(ChronoLocalDate other)` method. This flag method checks if this date is before the given date.

Increasing the start date day by day until the end date can be accomplished using the `LocalDate.plusDays(long daysToAdd)` method. Using these two methods in a for loop results in the following code:

```
for (LocalDate date = startLocalDate;
     date.isBefore(endLocalDate); date = date.plusDays(1)) {

    // do something with this day
    System.out.println(date);
}
```

A snapshot of the output should be as follows:

```
2019-02-01
2019-02-02
2019-02-03
...
2019-02-20
```

Starting with JDK 9

JDK 9 can solve this problem using a single line of code. This is possible thanks to the new `LocalDate.datesUntil(LocalDate endExclusive)` method. This method returns `Stream<LocalDate>` with an incremental step of one day:

```
startLocalDate.datesUntil(endLocalDate).forEach(System.out::println);
```

If the incremental step should be expressed in days, weeks, months, or years, then rely on `LocalDate.datesUntil(LocalDate endExclusive, Period step)`. For example, an incremental step of 1 week can be specified as follows:

```
startLocalDate.datesUntil(endLocalDate,
                          Period.ofWeeks(1)).forEach(System.out::println);
```

The output should be (weeks 1-8, weeks 8-15) as follows:

```
2019-02-01
2019-02-08
2019-02-15
```

74. Calculating age

Probably the most commonly used case of difference between two dates is about calculating the age of a person. Typically, the age of a person is expressed in years, but sometimes months, and even days, should be provided.

Before JDK 8

Before JDK 8, trying to provide a good solution can rely on `Calendar` and/or `SimpleDateFormat`. The code that is bundled to this book contains such a solution.

Starting with JDK 8

A better idea is to upgrade to JDK 8, and rely on the following straightforward snippet of code:

```
LocalDate startLocalDate = LocalDate.of(1977, 11, 2);
LocalDate endLocalDate = LocalDate.now();

long years = ChronoUnit.YEARS.between(startLocalDate, endLocalDate);
```

Adding months and days to the result is also easy to accomplish, thanks to the `Period` class:

```
Period periodBetween = Period.between(startLocalDate, endLocalDate);
```

Now, the age in years, months, and days can be obtained via `periodBetween.getYears()`, `periodBetween.getMonths()`, and `periodBetween.getDays()`.

For example, between the current date, February 28, 2019, and November 2, 1977, we have 41 years, 3 months, and 26 days.

75. Start and end of a day

In JDK 8, trying to find the start/end of a day can be accomplished in several ways.

Let's consider a day expressed via `LocalDate`:

```
LocalDate localDate = LocalDate.of(2019, 2, 28);
```

The solution to finding the start of the day February 28, 2019, relies on a method named `atStartOfDay()`. This method returns `LocalDateTime` from this date at the time of midnight, 00:00:

```
// 2019-02-28T00:00
LocalDateTime ldDayStart = localDate.atStartOfDay();
```

Alternatively, the solution can use the `of(LocalDate date, LocalTime time)` method. This method combines the given date and time into `LocalDateTime`. So, if the passed time is `LocalTime.MIN` (the time of midnight at the start of the day) then the result will be as follows:

```
// 2019-02-28T00:00
LocalDateTime ldDayStart = LocalDateTime.of(localDate, LocalTime.MIN);
```

The end of the day of a `LocalDate` object can be obtained using at least two solutions. One solution consist of relying on `LocalDate.atTime(LocalTime time)`. The resulting `LocalDateTime` can represent the combination of this date with the end of the day, if the solution passes as an argument, `LocalTime.MAX` (the time just before midnight at the end of the day):

```
// 2019-02-28T23:59:59.999999999
LocalDateTime ldDayEnd = localDate.atTime(LocalTime.MAX);
```

Alternatively, the solution can combine `LocalTime.MAX` with the given date, via the `atDate(LocalDate date)` method:

```
// 2019-02-28T23:59:59.999999999
LocalDateTime ldDayEnd = LocalTime.MAX.atDate(localDate);
```

Since `LocalDate` doesn't have the concept of a time zone, the preceding examples are prone to issues caused by different corner-cases, for example, Daylight Saving Time. Some Daylight Saving Times impose a change of hour at midnight (00:00 becomes 01:00 AM), which means that the start of the day is at 01:00:00, not at 00:00:00. In order to mitigate these issues, consider the following examples that extend the preceding examples to use `ZonedDateTime`, which is Daylight Saving Time aware:

```
// 2019-02-28T00:00+08:00[Australia/Perth]
ZonedDateTime ldDayStartZone
    = localDate.atStartOfDay(ZoneId.of("Australia/Perth"));

// 2019-02-28T00:00+08:00[Australia/Perth]
ZonedDateTime ldDayStartZone = LocalDateTime
    .of(localDate, LocalTime.MIN).atZone(ZoneId.of("Australia/Perth"));

// 2019-02-28T23:59:59.999999999+08:00[Australia/Perth]
ZonedDateTime ldDayEndZone = localDate.atTime(LocalTime.MAX)
    .atZone(ZoneId.of("Australia/Perth"));

// 2019-02-28T23:59:59.999999999+08:00[Australia/Perth]
ZonedDateTime ldDayEndZone = LocalTime.MAX.atDate(localDate)
    .atZone(ZoneId.of("Australia/Perth"));
```

Now, let's consider the following—`LocalDateTime`, February 28, 2019, 18:00:00:

```
LocalDateTime localDateTime = LocalDateTime.of(2019, 2, 28, 18, 0, 0);
```

The obvious solution is to extract `LocalDate` from `LocalDateTime` and apply the previous approaches. Another solution relies on the fact that every implementation of the `Temporal` interface (including `LocalDate`) can take advantage of the `with(TemporalField field, long newValue)` method. Mainly, the `with()` method returns a copy of this date with the specified field, `ChronoField`, set to `newValue`. So, if the solution sets `ChronoField.NANO_OF_DAY` (nanoseconds of a day) as `LocalTime.MIN`, then the result will be the start of the day. The trick here is to convert `LocalTime.MIN` to nanoseconds via `toNanoOfDay()`, as follows:

```
// 2019-02-28T00:00
LocalDateTime ldtDayStart = localDateTime
    .with(ChronoField.NANO_OF_DAY, LocalTime.MIN.toNanoOfDay());
```

This is equivalent to the following:

```
LocalDateTime ldtDayStart
    = localDateTime.with(ChronoField.HOUR_OF_DAY, 0);
```

The end of the day is pretty similar. Just pass `LocalTime.MAX` instead of `MIN`:

```
// 2019-02-28T23:59:59.999999999
LocalDateTime ldtDayEnd = localDateTime
    .with(ChronoField.NANO_OF_DAY, LocalTime.MAX.toNanoOfDay());
```

This is equivalent to the following:

```
LocalDateTime ldtDayEnd = localDateTime.with(
    ChronoField.NANO_OF_DAY, 8639999999999L);
```

Like `LocalDate`, the `LocalDateTime` object is not aware of time zones. In this case, `ZonedDateTime` can help:

```
// 2019-02-28T00:00+08:00[Australia/Perth]
ZonedDateTime ldtDayStartZone = localDateTime
    .with(ChronoField.NANO_OF_DAY, LocalTime.MIN.toNanoOfDay())
    .atZone(ZoneId.of("Australia/Perth"));

// 2019-02-28T23:59:59.999999999+08:00[Australia/Perth]
ZonedDateTime ldtDayEndZone = localDateTime
    .with(ChronoField.NANO_OF_DAY, LocalTime.MAX.toNanoOfDay())
    .atZone(ZoneId.of("Australia/Perth"));
```

As a bonus here, let's see the start/end of the day with UTC. Beside the solution relying on the `with()` method, another solution can rely on `toLocalDate()`, as follows:

```
// e.g., 2019-02-28T09:23:10.603572Z
ZonedDateTime zdt = ZonedDateTime.now(ZoneOffset.UTC);

// 2019-02-28T00:00Z
ZonedDateTime dayStartZdt
    = zdt.toLocalDate().atStartOfDay(zdt.getZone());

// 2019-02-28T23:59:59.999999999Z
ZonedDateTime dayEndZdt = zdt.toLocalDate()
    .atTime(LocalTime.MAX).atZone(zdt.getZone());
```



Because of the numerous issues with `java.util.Date` and `Calendar`, it is advisable to avoid trying to implement a solution to this problem with them.

76. Difference between two dates

Computing the difference between two dates is a very common task (for example, see the *Calculating age* section). Let's see a collection of other approaches that can be used to obtain the difference between two dates in milliseconds, seconds, hours, and so on.

Before JDK 8

The recommended way to represent date-time information is via the `java.util.Date` and `Calendar` classes. The easiest difference to compute is expressed in milliseconds. The code that is bundled to this book contains such a solution.

Starting with JDK 8

Starting with JDK 8, the recommended way to represent date-time information is via `Temporal` (for example, `DateTime`, `DateLocalTime`, `ZonedDateTime`, and so on).

Let's assume the following two `LocalDate` objects, January 1, 2018, and March 1, 2019:

```
LocalDate ld1 = LocalDate.of(2018, 1, 1);
LocalDate ld2 = LocalDate.of(2019, 3, 1);
```

The simplest way to compute the difference between these two `Temporal` objects is via the `ChronoUnit` class. Beside representing the standard set of date periods units, `ChronoUnit` comes with several handy methods, including `between(Temporal t1Inclusive, Temporal t2Exclusive)`. As its name suggests, the `between()` method calculates the amount of time between two `Temporal` objects. Let's see it at work to compute the difference between `ld1` and `ld2` in days, months, and years:

```
// 424
long betweenInDays = Math.abs(ChronoUnit.DAYS.between(ld1, ld2));

// 14
long betweenInMonths = Math.abs(ChronoUnit.MONTHS.between(ld1, ld2));

// 1
long betweenInYears = Math.abs(ChronoUnit.YEARS.between(ld1, ld2));
```

Alternatively, every `Temporal` exposes a method named `until()`. Actually, `LocalDate` has two, one that returns `Period` as a difference between two dates and another one that returns `long` as a difference between two dates in the specified time unit. Using the one that returns `Period` looks like this:

```
Period period = ld1.until(ld2);

// Difference as Period: 1y2m0d
System.out.println("Difference as Period: " + period.getYears() + "y"
    + period.getMonths() + "m" + period.getDays() + "d");
```

Using the one that allows us to specify the time unit looks like this:

```
// 424
long untilInDays = Math.abs(ld1.until(ld2, ChronoUnit.DAYS));

// 14
long untilInMonths = Math.abs(ld1.until(ld2, ChronoUnit.MONTHS));

// 1
long untilInYears = Math.abs(ld1.until(ld2, ChronoUnit.YEARS));
```

The `ChronoUnit.convert()` method is also useful in the case of `LocalDateTime`. Let's consider the following two `LocalDateTime` objects—January 1, 2018 22:15:15, and March 1, 2019 23:15:15:

```
LocalDateTime ldt1 = LocalDateTime.of(2018, 1, 1, 22, 15, 15);
LocalDateTime ldt2 = LocalDateTime.of(2018, 1, 1, 23, 15, 15);
```

Now, let's see the difference between `ldt1` and `ldt2`, when expressed in minutes:

```
// 60
long betweenInMinutesWithoutZone
    = Math.abs(ChronoUnit.MINUTES.between(ldt1, ldt2));
```

And, the difference when expressed in hours via the `LocalDateTime.until()` method:

```
// 1
long untilInMinutesWithoutZone
    = Math.abs(ldt1.until(ldt2, ChronoUnit.HOURS));
```

But, a really awesome thing about `ChronoUnit.between()` and `until()` is the fact that they work with `ZonedDateTime`. For example, let's consider `ldt1` in the Europe/Bucharest time zone and in the Australia/Perth time zone, plus one hour:

```
ZonedDateTime zdt1 = ldt1.atZone(ZoneId.of("Europe/Bucharest"));
ZonedDateTime zdt2 = zdt1.withZoneSameInstant(
    ZoneId.of("Australia/Perth")).plusHours(1);
```

Now, let's use `ChronoUnit.between()` to express the difference between `zdt1` and `zdt2` in minutes, and `ZonedDateTime.until()` to express the difference between `zdt1` and `zdt2` in hours:

```
// 60
long betweenInMinutesWithZone
    = Math.abs(ChronoUnit.MINUTES.between(zdt1, zdt2));

// 1
long untilInHoursWithZone
    = Math.abs(zdt1.until(zdt2, ChronoUnit.HOURS));
```

Finally, let's repeat this technique, but for two independent `ZonedDateTime` objects; one obtained for `ldt1` and one for `ldt2`:

```
ZonedDateTime zdt1 = ldt1.atZone(ZoneId.of("Europe/Bucharest"));
ZonedDateTime zdt2 = ldt2.atZone(ZoneId.of("Australia/Perth"));

// 300
long betweenInMinutesWithZone
    = Math.abs(ChronoUnit.MINUTES.between(zdt1, zdt2));

// 5
long untilInHoursWithZone
    = Math.abs(zdt1.until(zdt2, ChronoUnit.HOURS));
```

77. Implementing a chess clock

Starting with JDK 8, the `java.time` package has an abstract class named `Clock`. The main purpose of this class is to allow us to plug in different clocks when needed (for example, for testing purposes). By default, Java comes with four implementations: `SystemClock`, `OffsetClock`, `TickClock`, and `FixedClock`. For each of these implementations, there are static methods in the `Clock` class. For example, the following code creates `FixedClock` (a clock that always returns the same `Instant`):

```
Clock fixedClock = Clock.fixed(Instant.now(), ZoneOffset.UTC);
```

There is also `TickClock`, which returns the current `Instant` ticking in whole seconds for the given time zone:

```
Clock tickClock = Clock.tickSeconds(ZoneId.of("Europe/Bucharest"));
```



There is also a method that can be used to tick in whole minutes, `tickMinutes()`, and a generic one, `tick()`, which allows us to specify `Duration`.

A `Clock` class may also support time zones and offsets, but the most important method of a `Clock` class is `instant()`. This method returns the instant of `Clock`:

```
// 2019-03-01T13:29:34Z
System.out.println(tickClock.instant());
```



There is also the `millis()` method, which returns the current instant of the clock in milliseconds.

Let's assume that we want to implement a clock that acts a chess clock:

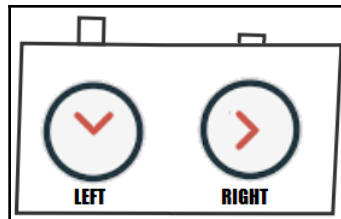

In order to implement a `Clock` class, there are several steps to follow:

1. Extend the `Clock` class.
2. Implement `Serializable`.
3. Override at least the abstract methods inherited from `Clock`.

A skeleton of a `Clock` class is as follows:

```
public class ChessClock extends Clock implements Serializable {

    @Override
    public ZoneId getZone() {
        ...
    }
}
```

```
@Override
public Clock withZone(ZoneId zone) {
    ...
}

@Override
public Instant instant() {
    ...
}
}
```

Our `ChessClock` will work only with UTC; no other time zone will be supported. This means that the `getZone()` and `withZone()` methods can be implemented as follows (of course, this can be modified in the future):

```
@Override
public ZoneId getZone() {
    return ZoneOffset.UTC;
}

@Override
public Clock withZone(ZoneId zone) {
    throw new UnsupportedOperationException(
        "The ChessClock works only in UTC time zone");
}
}
```

The climax of our implementation is the `instant()` method. The difficulty consists in managing two `Instant`, one for the player from the left (`instantLeft`) and one for the player from the right (`instantRight`). We can associate every call of the `instant()` method with the fact that the current player has performed a move, and now it is the other player's turn. So, basically, this logic says that the same player cannot call `instant()` twice. Implementing this logic, the `instant()` method is as follows:

```
public class ChessClock extends Clock implements Serializable {

    public enum Player {
        LEFT,
        RIGHT
    }

    private static final long serialVersionUID = 1L;

    private Instant instantStart;
    private Instant instantLeft;
    private Instant instantRight;
    private long timeLeft;
}
```

```
private long timeRight;
private Player player;

public ChessClock(Player player) {
    this.player = player;
}

public Instant gameStart() {

    if (this.instantStart == null) {
        this.timeLeft = 0;
        this.timeRight = 0;
        this.instantStart = Instant.now();
        this.instantLeft = instantStart;
        this.instantRight = instantStart;
        return instantStart;
    }

    throw new IllegalStateException(
        "Game already started. Stop it and try again.");
}

public Instant gameEnd() {

    if (this.instantStart != null) {
        instantStart = null;
        return Instant.now();
    }

    throw new IllegalStateException("Game was not started.");
}

@Override
public ZoneId getZone() {
    return ZoneOffset.UTC;
}

@Override
public Clock withZone(ZoneId zone) {
    throw new UnsupportedOperationException(
        "The ChessClock works only in UTC time zone");
}

@Override
public Instant instant() {

    if (this.instantStart != null) {
        if (player == Player.LEFT) {
```

```
        player = Player.RIGHT;

        long secondsLeft = Instant.now().getEpochSecond()
            - instantRight.getEpochSecond();
        instantLeft = instantLeft.plusSeconds(
            secondsLeft - timeLeft);
        timeLeft = secondsLeft;

        return instantLeft;
    } else {
        player = Player.LEFT;

        long secondsRight = Instant.now().getEpochSecond()
            - instantLeft.getEpochSecond();
        instantRight = instantRight.plusSeconds(
            secondsRight - timeRight);
        timeRight = secondsRight;

        return instantRight;
    }
}

throw new IllegalStateException("Game was not started.");
}
}
```

So, depending on which player calls the `instant()` method, the code computes the number of seconds needed by that player to think until she/he performed a move. Moreover, the code switches the player, so the next call of `instant()` will deal with the other player.

Let's consider a chess game starting at 2019-03-01T14:02:46.309459Z:

```
ChessClock chessClock = new ChessClock(Player.LEFT);

// 2019-03-01T14:02:46.309459Z
Instant start = chessClock.gameStart();
```

Further, the players perform the following sequence of movements until the player from the right wins the game:

```
Left moved first after 2 seconds: 2019-03-01T14:02:48.309459Z
Right moved after 5 seconds: 2019-03-01T14:02:51.309459Z
Left moved after 6 seconds: 2019-03-01T14:02:54.309459Z
Right moved after 1 second: 2019-03-01T14:02:52.309459Z
Left moved after 2 second: 2019-03-01T14:02:56.309459Z
Right moved after 3 seconds: 2019-03-01T14:02:55.309459Z
Left moved after 10 seconds: 2019-03-01T14:03:06.309459Z
Right moved after 11 seconds and win: 2019-03-01T14:03:06.309459Z
```

It looks like the clock has correctly registered the movements of the players.

Finally, the game is over after 40 seconds:

```
Game ended:2019-03-01T14:03:26.350749300Z
Instant end = chessClock.gameEnd();

Game duration: 40 seconds
// Duration.between(start, end).getSeconds();
```

Summary

Mission accomplished! This chapter provided a comprehensive overview of working with date and time information. A wide range of applications must manipulate this kind of information. Therefore, having the solutions to these problems under your tool belt is not optional. From `Date` and `Calendar` to `LocalDate`, `LocalTime`, `LocalDateTime`, `ZoneDateTime`, `OffsetDateTime`, `OffsetTime`, and `Instant`—they are all important and very useful in daily tasks that involve date and time.

Download the applications from this chapter to see the results and to see additional details.

4

Type Inference

This chapter includes 21 problems that involve JEP 286 or Java **Local Variable Type Inference (LVTI)**, also known as the `var` type. These problems have been carefully crafted to reveal the best practices and common mistakes that are involved in using `var`. By the end of this chapter, you will have learned everything you need to know about `var` to push it to production.

Problems

Use the following problems to test your type inference programming prowess. I strongly encourage you to give each problem a try before you turn to the solutions and download the example programs:

78. **Simple `var` example:** Write a program that exemplifies the correct usage of type inference (`var`) with respect to the code's readability.
79. **Using `var` with primitive types:** Write a program that exemplifies the usage of `var` with Java primitive types (`int`, `long`, `float`, and `double`).
80. **Using `var` and implicit type casting to sustain the code's maintainability:** Write a program that exemplifies how `var` and *implicit type casting* can sustain the code's maintainability.
81. **Explicit downcast or better avoid `var`:** Write a program that exemplifies the combination of `var` and explicit downcast and explain why `var` should be avoided.
82. **Avoid using `var` if the called names don't contain enough type information for humans:** Provide examples where `var` should be avoided because its combination with called *names* causes loss of information for humans.
83. **Combining LVTI and programming to the interface technique:** Write a program that exemplifies the usage of `var` via the *programming to the interface* technique.

84. **Combining LVTI and the diamond operator:** Write a program that exemplifies the usage of `var` with the *diamond* operator.
85. **Assigning an array to `var`:** Write a program that assigns an array to `var`.
86. **Using LVTI in compound declarations:** Explain and exemplify the usage of LVTI with compound declarations.
87. **LVTI and variable scope:** Explain and exemplify why LVTI should minimize the variable's scope as much as possible.
88. **LVTI and the ternary operator:** Write several snippets of code that exemplify the advantages of combining LVTI and the *ternary* operator.
89. **LVTI and `for` loops:** Write several examples that exemplify the usage of LVTI in `for` loops.
90. **LVTI and streams:** Write several snippets of code that exemplify the usage of LVTI and Java streams.
91. **Using LVTI to break up nested/large chains of expressions:** Write a program that exemplifies the usage of LVTI for breaking up a nested/large chain of expressions.
92. **LVTI and the method return and argument types:** Write several snippets of code that exemplify the usage of LVTI and Java methods in terms of return and argument types.
93. **LVTI and anonymous classes:** Write several snippets of code that exemplify the usage of LVTI in anonymous classes.
94. **LVTI can be `final` and *effectively final*:** Write several snippets of code that exemplify how LVTI can be used for `final` and *effectively final* variables.
95. **LVTI and lambdas:** Explain via several snippets of code how LVTI can be used in combination with lambda expressions.
96. **LVTI and `null` *initializers*, instance variables, and `catch` blocks variables:** Explain with examples how LVTI can be used in combination with `null` *initializers*, instance variables, and `catch` blocks.
97. **LVTI and generic types, `T`:** Write several snippets of code that exemplify how LVTI can be used in combination with generic types.
98. **LVTI, wildcards, covariants, and contravariants:** Write several snippets of code that exemplify how LVTI can be used in combination with wildcards, covariants, and contravariants.

Solutions

The following sections describe the solutions to the preceding problems. Remember that there usually isn't a single correct way to solve a particular problem. Also, remember that the explanations shown here include only the most interesting and important details that are needed to solve the problems. You can download the example solutions to view additional details and experiment with the programs from <https://github.com/PacktPublishing/Java-Coding-Problems>.

78. Simple var example

Starting with version 10, Java comes with JEP 286, or Java LVTI, also known as the var type.



The `var` identifier is not a Java *keyword*, it is a *reserved type name*.

This is a 100% compile feature with no side effects in terms of bytecode, runtime, or performance. In a nutshell, LVTI is applied to local variables and works as follows: the compiler checks the right-hand side and infers the real type (if the right-hand side is an *initializer*, then it uses that type).



This feature ensures compile-time safety. This means that we cannot compile an application that tries to achieve a wrong assignment. If the compiler has inferred the concrete/actual type of `var`, we can only assign the values of that type.

There are multiple benefits of LVTI; for example, it reduces code verbosity and mitigates redundancy and *boilerplate* code. Moreover, the time spent to write code can be reduced by LVTI, especially in cases that involve heavy declarations, as follows:

```
// without var
Map<Boolean, List<Integer>> evenAndOddMap...

// with var
var evenAndOddMap = ...
```

A controversial benefit is represented by code readability. Some voices sustain that using `var` reduces code readability, while other voices support the opposite. Depending on the use case, it may require a trade-off in readability, but the truth is that, typically, we pay a lot of attention to meaningful names for fields (instance variables) and we neglect the names of local variables. For example, let's consider the following method:

```
public Object fetchTransferableData(String data)
    throws UnsupportedOperationException, IOException {

    StringSelection ss = new StringSelection(data);
    DataFlavor[] df = ss.getTransferDataFlavors();
    Object obj = ss.getTransferData(df[0]);

    return obj;
}
```

This is a short method; it has a meaningful name and a clean implementation. But checkout the local variables' names. Their names are drastically reduced (they are just shortcuts), but this is not a problem since the left-hand side provides enough information that we can easily understand the type of each local variable. Now, let's write this code using LVTI:

```
public Object fetchTransferableData(String data)
    throws UnsupportedOperationException, IOException {

    var ss = new StringSelection(data);
    var df = ss.getTransferDataFlavors();
    var obj = ss.getTransferData(df[0]);

    return obj;
}
```

Obviously, the code's readability has decreased since it's now harder to infer the type of the local variables. As the following screenshot reveals, the compiler doesn't have a problem with inferring the correct types, but for humans, this is a lot more difficult:

Decompilation of the class containing this method:

```
public Object fetchTransferableData(String data)
    throws UnsupportedOperationException, IOException {

    StringSelection ss = new StringSelection(data);
    DataFlavor[] df = ss.getTransferDataFlavors();
    Object obj = ss.getTransferData(df[0]);

    return obj;
}
```

The solution to this problem consists of providing a meaningful name to local variables when relying on LVTI. For example, the code can regain its readability if the local variables' names are provided, as follows:

```
public Object fetchTransferableData(String data)
    throws UnsupportedOperationException, IOException {

    var stringSelection = new StringSelection(data);
    var dataFlavorsArray = stringSelection.getTransferDataFlavors();
    var obj = stringSelection.getTransferData(dataFlavorsArray[0]);

    return obj;
}
```

Nevertheless, the readability problem is also caused by the fact that, typically, we tend to look at the type as primary information and the variable name as secondary information, while this should be the opposite.

Let's look at two more examples that are meant to enforce the aforementioned statements. A method that uses collections (for example, `List`) is as follows:

```
// Avoid
public List<Player> fetchPlayersByTournament(String tournament) {

    var t = tournamentRepository.findByName(tournament);
    var p = t.getPlayers();

    return p;
}

// Prefer
public List<Player> fetchPlayersByTournament(String tournament) {

    var tournamentName = tournamentRepository.findByName(tournament);
    var playerList = tournamentName.getPlayers();

    return playerList;
}
```

Providing meaningful names for local variables doesn't mean falling into the *over-naming* technique.

For example, avoid naming variables by simply repeating the type name:

```
// Avoid
var fileCacheImageOutputStream
    = new FileCacheImageOutputStream(..., ...);
```

```
// Prefer
var outputStream = new FileCacheImageOutputStream(..., ...);

// Or
var outputStreamOfFoo = new FileCacheImageOutputStream(..., ...);
```

79. Using var with primitive types

The problem of using LVTI with primitive types (`int`, `long`, `float`, and `double`) is that the expected and inferred types may differ. Obviously, this causes confusion and unexpected behavior in code.

The guilty party in this situation is the *implicit type casting* used by the `var` type.

For example, let's consider the following two declarations that rely on explicit primitive types:

```
boolean valid = true; // this is of type boolean
char c = 'c';        // this is of type char
```

Now, let's replace the explicit primitive type with LVTI:

```
var valid = true; // inferred as boolean
var c = 'c';     // inferred as char
```

Nice! There are no problems so far! Now, let's have a look at another set of declarations based on explicit primitive types:

```
int intNumber = 10; // this is of type int
long longNumber = 10; // this is of type long
float floatNumber = 10; // this is of type float, 10.0
double doubleNumber = 10; // this is of type double, 10.0
```

Let's follow the logic from the first example and replace the explicit primitive types with LVTI:

```
// Avoid
var intNumber = 10; // inferred as int
var longNumber = 10; // inferred as int
var floatNumber = 10; // inferred as int
var doubleNumber = 10; // inferred as int
```

Conforming to the following screenshot, all four variables have been inferred as integers:

```
Decompilation of the class containing these declarations:  
int intNumber = 10;  
int longNumber = 10;  
int floatNumber = 10;  
int doubleNumber = 10;
```

The solution to this problem consists of using explicit Java *literals*:

```
// Prefer  
var intNumber = 10;      // inferred as int  
var longNumber = 10L;   // inferred as long  
var floatNumber = 10F;  // inferred as float, 10.0  
var doubleNumber = 10D; // inferred as double, 10.0
```

Finally, let's consider the case of a number with decimals, as follows:

```
var floatNumber = 10.5; // inferred as double
```

The variable name suggests that 10.5 is float, but actually, it is inferred as double. So, it is advisable to rely on *literals* even for numbers with decimals (especially for numbers of the float type):

```
var floatNumber = 10.5F; // inferred as float
```

80. Using var and implicit type casting to sustain the code's maintainability

In the previous section, *Using var with primitive types*, we saw that combining var with *implicit type casting* can cause real problems. But in certain scenarios, this combination can be advantageous and sustain the code's maintainability.

Let's consider the following scenario—we need to write a method that sits between two existing methods of an external API named `ShoppingAddicted` (by extrapolation, these methods can be two web services, endpoints, and so on). One method is dedicated to returning the best price for a given shopping cart. Basically, this method takes a bunch of products and queries different online stores to fetch the best price.

The resulting price is returned as `int`. A stub of this method is listed as follows:

```
public static int fetchBestPrice(String[] products) {  
    float realprice = 399.99F; // code to query the prices in stores  
    int price = (int) realprice;  
  
    return price;  
}
```

The other method receives the price as `int` and performs the payment. If the payment is successful, it returns `true`:

```
public static boolean debitCard(int amount) {  
    return true;  
}
```

Now, by programming with respect to this code, our method will act as a client, as follows (the customers can decide what items to buy, and our code will return the best price for them and debit their cards accordingly):

```
// Avoid  
public static boolean purchaseCart(long customerId) {  
  
    int price = ShoppingAddicted.fetchBestPrice(new String[0]);  
    boolean paid = ShoppingAddicted.debitCard(price);  
  
    return paid;  
}
```

But after some time, the owners of the `ShoppingAddicted` API realize that they lose money by converting the real price into `int` (for example, the real price is 399.99, but in `int` form, it's 399.0, which means a loss of 99 cents). So, they decide to quit this practice and return the real price as `float`:

```
public static float fetchBestPrice(String[] products) {  
    float realprice = 399.99F; // code to query the prices in stores  
  
    return realprice;  
}
```

Since the returned price is `float`, `debitCard()` is updated as well:

```
public static boolean debitCard(float amount) {  
    return true;  
}
```

But once we upgrade to the new release of the `ShoppingAddicted` API, the code will fail with a possible *lossy conversion from float into int* exceptions. This is normal since our code expects `int`. Since our code doesn't tolerate these modifications well, the code needs to be modified accordingly.

Nevertheless, if we have anticipated this situation and used `var` instead of `int`, then the code will work without problems thanks to *implicit type casting*:

```
// Prefer  
public static boolean purchaseCart(long customerId) {  
  
    var price = ShoppingAddicted.fetchBestPrice(new String[0]);  
    var paid = ShoppingAddicted.debitCard(price);  
  
    return paid;  
}
```

81. Explicit downcast or better avoid var

In the *Using var with primitive types* section, we talked about using *literals* with primitive types (`int`, `long`, `float`, and `double`) to avoid issues caused by *implicit type casting*. But not all Java primitive types can take advantage of *literals*. In such a situation, the best approach is to avoid using `var`. But let's see why!

Check out the following declarations of `byte` and `short` variables:

```
byte byteNumber = 25;    // this is of type byte  
short shortNumber = 1463; // this is of type short
```

If we replace the explicit types with `var`, then the inferred type will be `int`:

```
var byteNumber = 25;    // inferred as int  
var shortNumber = 1463; // inferred as int
```

Unfortunately, there are no *literals* available for these two primitive types. The only approach to help the compiler to infer the correct types is to rely on an explicit downcast:

```
var byteNumber = (byte) 25;    // inferred as byte
var shortNumber = (short) 1463; // inferred as short
```

While this code compiles successfully and works as expected, we cannot say that using `var` brought any value compared to using explicit types. So, in this case, it is better to avoid `var` and explicit downcast.

82. Avoid using var if the called names don't contain enough type information for humans

Well, `var` is not a silver bullet, and this problem will highlight this once again. The following snippet of code can be written using explicit types or `var` without losing information:

```
// using explicit types
MemoryCacheImageInputStream is =
    new MemoryCacheImageInputStream(...);
JavaCompiler jc = ToolProvider.getSystemJavaCompiler();
StandardJavaFileManager fm = compiler.getStandardFileManager(...);
```

So, migrating the preceding snippet of code to `var` will result in the following code (the variables names have been chosen by visually inspecting the called *names* from the right-hand side):

```
// using var
var inputStream = new MemoryCacheImageInputStream(...);
var compiler = ToolProvider.getSystemJavaCompiler();
var fileManager = compiler.getStandardFileManager(...);
```

The same will happen at the border of over-naming:

```
// using var
var inputStreamOfCachedImages = new MemoryCacheImageInputStream(...);
var javaCompiler = ToolProvider.getSystemJavaCompiler();
var standardFileManager = compiler.getStandardFileManager(...);
```

So, the preceding code doesn't raise any issues in choosing the variable's names and readability. The called *names* contain enough information for humans to feel comfortable with `var`.

But let's consider the following snippet of code:

```
// Avoid
public File fetchBinContent() {
    return new File(...);
}

// called from another place
// notice the variable name, bin
var bin = fetchBinContent();
```

For humans, it is pretty difficult to infer the type that's returned by the called *name* without inspecting the returned type of this *name*, `fetchBinContent()`. As a rule of thumb, in such cases, the solution should avoid `var` and rely on explicit types since there is not enough information on the right-hand side for us to choose a proper name for the variable and obtain highly readable code:

```
// called from another place
// now the left-hand side contains enough information
File bin = fetchBinContent();
```

So, if `var` in combination with the called *names* causes loss of clarity, then it is better to avoid the usage of `var`. Ignoring this statement may lead to confusion and will increase the time needed to understand and/or extend the code.

Consider another example based on the `java.nio.channels.Selector` class. This class exposes a `static` method named `open()` that returns a newly opened `Selector`. But if we capture this return in a variable declared with `var`, it's tempting to think that this method may return a `boolean` representing the success of opening the current selector. Using `var` without considering the possible loss of clarity can produce exactly these kinds of problems. Just a few issues like this one and the code will become a real pain.

83. Combining LVTI and programming to the interface technique

Java best practices encourage us to bind the code to the abstraction. In other words, we need to rely on the *programming to the interface* technique.

This technique fits very well for collection declarations. For example, it is advisable to declare `ArrayList` as follows:

```
List<String> players = new ArrayList<>();
```

We should also avoid something like this:

```
ArrayList<String> players = new ArrayList<>();
```

By following the first example, the code instantiates the `ArrayList` class (or `HashSet`, `HashMap`, and so on), but declares a variable of the `List` type (or `Set`, `Map`, and so on). Since `List`, `Set`, `Map`, and many more are interfaces (or contracts), it is very easy to replace the instantiation with other implementation of `List` (`Set`, and `Map`) without subsequent modifications being made to the code.

Unfortunately, LVTI cannot take advantage of the *programming to the interface* technique. In other words, when we use `var`, the inferred type is the concrete implementation, not the contract. For example, replacing `List<String>` with `var` will result in the inferred type, `ArrayList<String>`:

```
// inferred as ArrayList<String>
var playerList = new ArrayList<String>();
```

Nevertheless, there are some explanations that sustain this behavior:

- LVTI acts at the local level (local variables) where the *programming to the interface* technique is used less than method parameters/return types or field types.
- Since local variables have a small scope, the modifications that are induced by switching to another implementation should be small as well. Switching implementation should have a small impact on detecting and fixing the code.
- LVTI sees the code from the right-hand side as an *initializer* that's useful for inferring the actual type. If this *initializer* is going to be modified in the future, then the inferred type may differ, and this will cause problems in the code that uses this variable.

84. Combining LVTI and the diamond operator

As a rule of thumb, LVTI combined with the *diamond* operator may result in unexpected inferred types if the information that's needed for inferring the expected type is not present in the right-hand side.

Before JDK 7, that is, Project Coin, `List<String>` would be declared as follows:

```
List<String> players = new ArrayList<String>();
```

Basically, the preceding example explicitly specifies the generic class's instantiation parameter type. Starting with JDK 7, Project Coin introduced the *diamond* operator, which is capable of inferring the generic class instantiation parameter type, as follows:

```
List<String> players = new ArrayList<>();
```

Now, if we think about this example in terms of LVTI, we will get the following result:

```
var playerList = new ArrayList<>();
```

But what will be the inferred type now? Well, we have a problem because the inferred type will be `ArrayList<Object>`, not `ArrayList<String>`. The explanation is quite obvious: the information that's needed for inferring the expected type (`String`) is not present (notice that there is no `String` type mentioned in the right-hand side). This instructs LVTI to infer the type that is the broadest applicable type, which, in this case, is `Object`.

But if `ArrayList<Object>` was not our intention, then we need a solution to this problem. The solution is to provide the information that's needed for inferring the expected type, as follows:

```
var playerList = new ArrayList<String>();
```

Now, the inferred type is `ArrayList<String>`. The type can be inferred indirectly as well. See the following example:

```
var playerStack = new ArrayDeque<String>();  
  
// inferred as ArrayList<String>  
var playerList = new ArrayList<>(playerStack);
```

It can also be inferred indirectly in the following way:

```
Player p1 = new Player();  
Player p2 = new Player();  
var listOfPlayer = List.of(p1, p2); // inferred as List<Player>  
  
// Don't do this!  
var listOfPlayer = new ArrayList<>(); // inferred as ArrayList<Object>  
listOfPlayer.add(p1);  
listOfPlayer.add(p2);
```

85. Assigning an array to var

As a rule of thumb, assigning an array to `var` doesn't require brackets, `[]`. Defining an array of `int` via the corresponding explicit type can be done as follows:

```
int[] numbers = new int[10];

// or, less preferred
int numbers[] = new int[10];
```

Now, trying to intuit how to use `var` instead of `int` may result in the following attempts:

```
var[] numberArray = new int[10];
var numberArray[] = new int[10];
```

Unfortunately, none of these two approaches will compile. The solution requires us to remove the brackets from the left-hand side:

```
// Prefer
var numberArray = new int[10]; // inferred as array of int, int[]
numberArray[0] = 3;           // works
numberArray[0] = 3.2;         // doesn't work
numbers[0] = "3";             // doesn't work
```

There is a common practice to initialize an array at declaration time, as follows:

```
// explicit type work as expected
int[] numbers = {1, 2, 3};
```

However, trying to use `var` will not work (will not compile):

```
// Does not compile
var numberArray = {1, 2, 3};
var numberArray[] = {1, 2, 3};
var[] numberArray = {1, 2, 3};
```

This code doesn't compile because the right-hand side doesn't have its own type.

86. Using LVTI in compound declarations

A compound declaration allows us to declare a group of variables of the same type without repeating the type. The type is specified a single time and the variables are demarcated by a comma:

```
// using explicit type
String pending = "pending", processed = "processed",
    deleted = "deleted";
```

Replacing `String` with `var` will result in code that doesn't compile:

```
// Does not compile
var pending = "pending", processed = "processed", deleted = "deleted";
```

The solution to this problem is to transform the compound declaration into one declaration per single line:

```
// using var, the inferred type is String
var pending = "pending";
var processed = "processed";
var deleted = "deleted";
```

So, as a rule of thumb, LVTI cannot be used in compound declarations.

87. LVTI and variable scope

The clean code best practices include keeping a small scope for all local variables. This is one of the clean code golden rules that was followed even before the existence of LVTI.

This rule sustains the readability and debugging phase. It can speed up the process of finding bugs and writing fixes. Consider the following example that breaks down this rule:

```
// Avoid
...
var stack = new Stack<String>();
stack.push("John");
stack.push("Martin");
stack.push("Anghel");
stack.push("Christian");

// 50 lines of code that doesn't use stack
```

```
// John, Martin, Anghel, Christian
stack.forEach(...);
```

So, the preceding code declares a stack with four names, contains 50 lines of code that don't use this stack, and finishes with a loop of this stack via the `forEach()` method. This method is inherited from `java.util.Vector` and will loop the stack as any vector (John, Martin, Anghel, Christian). This is the order of traversal that we want.

But later on, we decide to switch from the stack to `ArrayDeque` (the reason is irrelevant). This time, the `forEach()` method will be the one provided by the `ArrayDeque` class. The behavior of this method is different from `Vector.forEach()`, meaning that the loop will traverse the entries following the **Last In First Out (LIFO)** traversal (Christian, Anghel, Martin, John):

```
// Avoid
...
var stack = new ArrayDeque<String>();
stack.push("John");
stack.push("Martin");
stack.push("Anghel");
stack.push("Christian");

// 50 lines of code that doesn't use stack

// Christian, Anghel, Martin, John
stack.forEach(...);
```

This was not our intention! We switched to `ArrayDeque` for other purposes, not for affecting the looping order. But it is pretty difficult to see that there was a bug in the code since the part of the code containing the `forEach()` part is not in proximity of the code where we completed the modifications (50 lines below this line of code). It is our duty to come up with a solution that maximizes the chances of getting this bug fixed quickly and avoiding a bunch of scrolling up and down to understand what is going on. The solution consists of following the clean code rule we invoked earlier and writing this code with a small scope for the `stack` variable:

```
// Prefer
...
var stack = new Stack<String>();
stack.push("John");
stack.push("Martin");
stack.push("Anghel");
stack.push("Christian");
```

```
// John, Martin, Anghel, Christian
stack.forEach(...);

// 50 lines of code that doesn't use stack
```

Now, when we switch from `Stack` to `ArrayQueue`, we should notice the bug faster and be able to fix it.

88. LVTI and the ternary operator

As long as it is written correctly, the *ternary* operator allows us to use different types of operands on the right-hand side. For example, the following code will not compile:

```
// Does not compile
List evensOrOdds = containsEven ?
    List.of(10, 2, 12) : Set.of(13, 1, 11);

// Does not compile
Set evensOrOdds = containsEven ?
    List.of(10, 2, 12) : Set.of(13, 1, 11);
```

Nevertheless, this code can be fixed by rewriting it using the correct/supported explicit types:

```
Collection evensOrOdds = containsEven ?
    List.of(10, 2, 12) : Set.of(13, 1, 11);

Object evensOrOdds = containsEven ?
    List.of(10, 2, 12) : Set.of(13, 1, 11);
```

A similar attempt will fail for the following snippet of code:

```
// Does not compile
int numberOrText = intOrString ? 2234 : "2234";

// Does not compile
String numberOrText = intOrString ? 2234 : "2234";
```

However, it can be fixed like this:

```
Serializable numberOrText = intOrString ? 2234 : "2234";

Object numberOrText = intOrString ? 2234 : "2234";
```

So, in order to have a *ternary* operator with different types of operands on the right-hand side, the developer must match the correct type that supports both conditional branches. Alternatively, the developer can rely on LVTI, as follows (of course, this works for the same types of operands as well):

```
// inferred type, Collection<Integer>
var evensOrOddsCollection = containsEven ?
    List.of(10, 2, 12) : Set.of(13, 1, 11);

// inferred type, Serializable
var numberOrText = intOrString ? 2234 : "2234";
```

Don't conclude from these examples that the `var` type is inferred at runtime! It is NOT!

89. LVTI and for loops

Declaring simple `for` loops using explicit types is a trivial task, as follows:

```
// explicit type
for (int i = 0; i < 5; i++) {
    ...
}
```

Alternatively, we can use an enhanced `for` loop:

```
List<Player> players = List.of(
    new Player(), new Player(), new Player());
for (Player player: players) {
    ...
}
```

Starting with JDK 10, we can replace the explicit types of the variables, `i` and `player`, with `var`, as follows:

```
for (var i = 0; i < 5; i++) { // i is inferred of type int
    ...
}

for (var player: players) { // i is inferred of type Player
    ...
}
```

Using `var` can be helpful when the type of a looped array, collection, and so on is changed. For example, by using `var`, both versions of the following array can be looped without specifying the explicit type:

```
// a variable 'array' representing an int[]
int[] array = { 1, 2, 3 };

// or the same variable, 'array', but representing a String[]
String[] array = {
    "1", "2", "3"
};

// depending on how 'array' is defined
// 'i' will be inferred as int or as String
for (var i: array) {
    System.out.println(i);
}
```

90. LVTI and streams

Let's consider the following `Stream<Integer>` stream:

```
// explicit type
Stream<Integer> numbers = Stream.of(1, 2, 3, 4, 5);
numbers.filter(t -> t % 2 == 0).forEach(System.out::println);
```

Using LVTI instead of `Stream<Integer>` is pretty straightforward. Simply replace `Stream<Integer>` with `var`, as follows:

```
// using var, inferred as Stream<Integer>
var numberStream = Stream.of(1, 2, 3, 4, 5);
numberStream.filter(t -> t % 2 == 0).forEach(System.out::println);
```

Here is another example:

```
// explicit types
Stream<String> paths = Files.lines(Path.of("..."));
List<File> files = paths.map(p -> new File(p)).collect(toList());

// using var
// inferred as Stream<String>
var pathStream = Files.lines(Path.of(""));

// inferred as List<File>
var fileList = pathStream.map(p -> new File(p)).collect(toList());
```

It looks like Java 10, LVTI, Java 8, and the `Stream` API make a good team.

91. Using LVTI to break up nested/large chains of expressions

Large/nested expressions are usually snippets of codes that look pretty impressive and are intimidating. They are commonly seen as pieces of *smart* or *clever* code. It is controversial as to whether this is good or bad, but most likely, the balance tends to be in favor of those who claim that such code should be avoided. For example, check out the following expression:

```
List<Integer> ints = List.of(1, 1, 2, 3, 4, 4, 6, 2, 1, 5, 4, 5);

// Avoid
int result = ints.stream()
    .collect(Collectors.partitioningBy(i -> i % 2 == 0))
    .values()
    .stream()
    .max(Comparator.comparing(List::size)
        .orElse(Collections.emptyList()))
    .stream()
    .mapToInt(Integer::intValue)
    .sum();
```

Such expressions can be written deliberately or they can represent the final result of an incremental process that enriches an initially small expression in time. Nevertheless, when such expressions start to become gaps in readability, they must be broken into pieces via local variables. But this is not fun and can be considered exhausting work that we want to avoid:

```
List<Integer> ints = List.of(1, 1, 2, 3, 4, 4, 6, 2, 1, 5, 4, 5);

// Prefer
Collection<List<Integer>> evenAndOdd = ints.stream()
    .collect(Collectors.partitioningBy(i -> i % 2 == 0))
    .values();

List<Integer> evenOrOdd = evenAndOdd.stream()
    .max(Comparator.comparing(List::size)
        .orElse(Collections.emptyList()));

int sumEvenOrOdd = evenOrOdd.stream()
    .mapToInt(Integer::intValue)
    .sum();
```

Check out the types of the local variables in the preceding code. We have `Collection<List<Integer>>`, `List<Integer>`, and `int`. It is obvious that these explicit types require some time to be fetched and written. This may be a good reason to avoid breaking this expression into pieces. Nevertheless, the triviality of using the `var` type instead of explicit types is tempting if we wish to adopt the local variable's style because it saves time that's usually spent fetching the explicit types:

```
var intList = List.of(1, 1, 2, 3, 4, 4, 6, 2, 1, 5, 4, 5);

// Prefer
var evenAndOdd = intList.stream()
    .collect(Collectors.partitioningBy(i -> i % 2 == 0))
    .values();

var evenOrOdd = evenAndOdd.stream()
    .max(Comparator.comparing(List::size))
    .orElse(Collections.emptyList());

var sumEvenOrOdd = evenOrOdd.stream()
    .mapToInt(Integer::intValue)
    .sum();
```

Awesome! Now, it is the compiler's job to infer the types of these local variables. We only choose the points where we break the expression and demarcate them with `var`.

92. LVTI and the method return and argument types

As a rule of thumb, LVTI cannot be used as a return method type or as an argument method type; instead, variables of the `var` type can be passed as method arguments or store a return method. Let's iterate these statements via several examples:

- LVTI cannot be used as the method return type—the following code doesn't compile:

```
// Does not compile
public var fetchReport(Player player, Date timestamp) {

    return new Report();
}
```

- LVTI cannot be used as a method argument type—the following code doesn't compile:

```
public Report fetchReport(var player, var timestamp) {  
    return new Report();  
}
```

- Variables of the `var` type can be passed as method arguments or store a return method—the following code compiles successfully and it works:

```
public Report checkPlayer() {  
    var player = new Player();  
    var timestamp = new Date();  
    var report = fetchReport(player, timestamp);  
    return report;  
}  
  
public Report fetchReport(Player player, Date timestamp) {  
    return new Report();  
}
```

93. LVTI and anonymous classes

LVTI can be used for anonymous classes. Let's take a look at the following example of an anonymous class that uses an explicit type for the `weighter` variable:

```
public interface Weighter {  
    int getWeight(Player player);  
}  
  
Weighter weighter = new Weighter() {  
    @Override  
    public int getWeight(Player player) {  
        return ...;  
    }  
};  
  
Player player = ...;  
int weight = weighter.getWeight(player);
```

Now, look at what happens if we use LVTI:

```
var weighter = new Weighter() {
    @Override
    public int getWeight(Player player) {
        return ...;
    }
};
```

94. LVTI can be final and effectively final

As a quick reminder, *starting in Java SE 8, a local class can access local variables and parameters of the enclosing block that are final or effectively final. A variable or parameter whose value is never changed after it is initialized is effectively final.*

The following snippet of code represents the use case of an *effectively final* variable (trying to reassign the `ratio` variable will result in an error, which means that this variable is *effectively final*) and two `final` variables (trying to reassign the `limit` and `bmi` variables will result in an error, which means that these variables are `final`):

```
public interface Weighter {
    float getMarginOfError();
}

float ratio = fetchRatio(); // this is effectively final

var weighter = new Weighter() {
    @Override
    public float getMarginOfError() {
        return ratio * ...;
    }
};

ratio = fetchRatio(); // this reassignment will cause error

public float fetchRatio() {

    final float limit = new Random().nextFloat(); // this is final
    final float bmi = 0.00023f; // this is final

    limit = 0.002f; // this reassignment will cause error
    bmi = 0.25f; // this reassignment will cause error

    return limit * bmi / 100.12f;
}
```

Now, let's replace the explicit types with `var`. The compiler will infer the correct types for these variables (`ratio`, `limit`, and `bmi`) and maintain their state—`ratio` will be *effectively final* while `limit` and `bmi` are `final`. Trying to reassign any of them will cause a specific error:

```
var ratio = fetchRatio(); // this is effectively final

var weighter = new Weighter() {
    @Override
    public float getMarginOfError() {
        return ratio * ...;
    }
};

ratio = fetchRatio(); // this reassignment will cause error

public float fetchRatio() {

    final var limit = new Random().nextFloat(); // this is final
    final var bmi = 0.00023f; // this is final

    limit = 0.002f; // this reassignment will cause error
    bmi = 0.25f; // this reassignment will cause error

    return limit * bmi / 100.12f;
}
```

95. LVTI and lambdas

The problem with using LVTI and lambdas is that the concrete type cannot be inferred. Lambdas and method reference *initializers* are not allowed. This statement is part of `var` limitations; therefore, lambda expressions and method references need explicit target types.

For example, the following snippet of code will not compile:

```
// Does not compile
// lambda expression needs an explicit target-type
var incrementX = x -> x + 1;

// method reference needs an explicit target-type
var exceptionIAE = IllegalArgumentException::new;
```

Since `var` cannot be used, these two snippets of code need to be written as follows:

```
Function<Integer, Integer> incrementX = x -> x + 1;
Supplier<IllegalArgumentException> exceptionIAE
    = IllegalArgumentException::new;
```

But in the context of lambdas, Java 11 allows us to use `var` in lambda parameters. For example, the following code is working in Java 11 (more details can be found in *JEP 323: Local-Variable Syntax for Lambda Parameters* at <https://openjdk.java.net/jeps/323>):

```
@FunctionalInterface
public interface Square {
    int calculate(int x);
}

Square square = (var x) -> x * x;
```

However, keep in mind that the following will not work:

```
var square = (var x) -> x * x; // cannot infer
```

96. LVTI and null *initializers*, instance variables, and catch blocks variables

What does LVTI have in common with null *initializers*, instance variables, and catch blocks variables? Well, LVTI cannot be used with any of them. The following attempts will fail:

- LVTI cannot be used with null *initializers*:

```
// result in an error of type: variable initializer is 'null'
var message = null;

// result in: cannot use 'var' on variable without initializer
var message;
```

- LVTI cannot be used with instance variables (fields):

```
public class Player {

    private var age; // error: 'var' is not allowed here
    private var name; // error: 'var' is not allowed here
    ...
}
```

- LVTI cannot be used in `catch` block variables:

```
try {
    TimeUnit.NANOSECONDS.sleep(1000);
} catch (var ex) { ... }
```

Try-with-resource

On the other hand, the `var` type is a very nice fit for *try-with-resource*, as in the following example:

```
// explicit type
try (PrintWriter writer = new PrintWriter(new File("welcome.txt"))) {
    writer.println("Welcome message");
}

// using var
try (var writer = new PrintWriter(new File("welcome.txt"))) {
    writer.println("Welcome message");
}
```

97. LVTI and generic types, T

In order to understand how LVTI can be combined with generic types, let's start with an example. The following method is a classical usage case of a generic type, `T`:

```
public static <T extends Number> T add(T t) {
    T temp = t;
    ...
    return temp;
}
```

In this case, we can replace `T` with `var` and the code will work fine:

```
public static <T extends Number> T add(T t) {
    var temp = t;
    ...
    return temp;
}
```

So, local variables that have generic types can take advantage of LVTI. Let's look at some other examples, first using the generic type, T:

```
public <T extends Number> T add(T t) {  
  
    List<T> numberList = new ArrayList<T>();  
    numberList.add(t);  
    numberList.add((T) Integer.valueOf(3));  
    numberList.add((T) Double.valueOf(3.9));  
  
    // error: incompatible types: String cannot be converted to T  
    // numbers.add("5");  
  
    return numberList.get(0);  
}
```

Now, let's replace `List<T>` with `var`:

```
public <T extends Number> T add(T t) {  
  
    var numberList = new ArrayList<T>();  
    numberList.add(t);  
    numberList.add((T) Integer.valueOf(3));  
    numberList.add((T) Double.valueOf(3.9));  
  
    // error: incompatible types: String cannot be converted to T  
    // numbers.add("5");  
  
    return numberList.get(0);  
}
```

Pay attention and double-check the `ArrayList` instantiation for the presence of T. Don't do this (this will be inferred as `ArrayList<Object>` and will ignore the real type behind the generic type, T):

```
var numberList = new ArrayList<>();
```

98. LVTI, wildcards, covariants, and contravariants

Replacing wildcards, covariants, and contravariants with LVTI is a delicate job and should be done with full awareness of the consequences.

LVTI and wildcards

First, let's talk about LVTI and wildcards (?). It is a common practice to associate wildcards with `Class` and write something like this:

```
// explicit type
Class<?> clazz = Long.class;
```

In such cases, there is no problem with using `var` instead of `Class<?>`. Depending on the right-hand side type, the compiler will infer the correct type. In this example, the compiler will infer `Class<Long>`.

But notice that replacing wildcards with LVTI should be done carefully and that you should be aware of the consequences (or side effects). Let's look at an example where replacing a wildcard with `var` is a bad choice. Consider the following piece of code:

```
Collection<?> stuff = new ArrayList<>();
stuff.add("hello"); // compile time error
stuff.add("world"); // compile time error
```

This code doesn't compile because of incompatible types. A very bad approach would be to fix this code by replacing the wildcard with `var`, as follows:

```
var stuff = new ArrayList<>();
strings.add("hello"); // no error
strings.add("world"); // no error
```

By using `var`, the error will disappear, but this is not what we had in mind when we wrote the preceding code (the code with type incompatibility errors). So, as a rule of thumb, don't replace `Foo<?>` with `var` just because some annoying errors will disappear by magic! Try to think about what the intended task was and act accordingly. For example, maybe in the preceding snippet of code, we tried to define `ArrayList<String>` and, by mistake, ended up with `Collection<?>`.

LVTI and covariants/contravariants

Replacing covariants (`Foo<? extends T>`) or contravariants (`Foo<? super T>`) with LVTI is a dangerous approach and should be avoided.

Check out the following snippet of code:

```
// explicit types
Class<? extends Number> intNumber = Integer.class;
Class<? super FileReader> fileReader = Reader.class;
```

In the covariant, we have an upper bound represented by the `Number` class, while in the contravariant, we have a lower bound represented by the `FilterReader` class. Having these bounds (or constraints) in place, the following code will trigger a specific compile-time error:

```
// Does not compile
// error: Class<Reader> cannot be converted
//       to Class<? extends Number>
Class<? extends Number> intNumber = Reader.class;

// error: Class<Integer> cannot be converted
//       to Class<? super FilterReader>
Class<? super FilterReader> fileReader = Integer.class;
```

Now, let's use `var` instead of the preceding covariant and contravariant:

```
// using var
var intNumber = Integer.class;
var fileReader = Reader.class;
```

This code will not cause any issues. Now, we can assign any class to these variables so that our bounds/constraints vanish. This is not what we intended to do:

```
// this will compile just fine
var intNumber = Reader.class;
var fileReader = Integer.class;
```

So, using `var` in place of our covariant and contravariant was a bad choice!

Summary

This was the last problem of this chapter. Take a look at *JEP 323: Local-Variable Syntax for Lambda Parameters* (<https://openjdk.java.net/jeps/323>) and *JEP 301: Enhanced Enums* (<http://openjdk.java.net/jeps/301>) for more information. Adopting these features should be pretty smooth as long as you are familiar with the problems that were covered in this chapter.

Download the applications from this chapter to see the results and additional details.

5

Arrays, Collections, and Data Structures

This chapter includes 30 problems that involve arrays, collections, and several data structures. The aim is to provide solutions to a category of problems encountered in a wide range of applications, including sorting, finding, comparing, ordering, reversing, filling, merging, copying, and replacing. The solutions provided are implemented in Java 8-12 and they can also be used as a basis for solving other related issues. At the end of this chapter, you will have at your disposal a solid breadth of knowledge that will prove useful in solving a variety of problems involving arrays, collections, and data structures.

Problems

Use the following problems to test your programming prowess based on arrays, collections, and data structures. I strongly encourage you to give each problem a try before you turn to the solutions and download the example programs:

99. **Sorting an array:** Write several programs that exemplify different sorting algorithms for arrays. Also, write a program for shuffling arrays.
100. **Finding an element in an array:** Write several programs that exemplify how to find the given element (primitive and object) in a given array. Find the index and/or simply check whether the value is in the array.
101. **Checking whether two arrays are equal or mismatches:** Write a program that checks whether the two given arrays are equals or whether there is a mismatch.
102. **Comparing two arrays lexicographically:** Write a program that compares the given arrays lexicographically.

103. **Creating a stream from an array:** Write a program that creates a stream from the given array.
104. **Minimum, maximum, and average of an array:** Write a program that computes the maximum, minimum, and average of the given array.
105. **Reversing an array:** Write a program that reverses the given array.
106. **Filling and setting an array:** Write several examples for filling up an array and setting all elements based on a generator function to compute each element.
107. **Next Greater Element (NGE):** Write a program that returns the NGE for each element of an array.
108. **Changing array size:** Write a program that adds an element to an array by increasing its size by one. In addition, write a program that increases the size of an array with the given length.
109. **Creating unmodifiable/immutable collections:** Write several examples that create unmodifiable and immutable collections.
110. **Mapping a default value:** Write a program that gets a value from `Map` or a default value.
111. **Computing whether absent/present in a `Map`:** Write a program that computes the value of an absent key or a new value of a present key.
112. **Removal from a `Map`:** Write a program that removes from a `Map` by means of the given key.
113. **Replacing entries from a `Map`:** Write a program that replaces the given entries from a `Map`.
114. **Comparing two maps:** Write a program that compares two maps.
115. **Merging two maps:** Write a program that merges two given maps.
116. **Copying `HashMap`:** Write a program that performs a shallow and deep copy of `HashMap`.
117. **Sorting a `Map`:** Write a program that sorts a `Map`.
118. **Removing all elements of a collection that match a predicate:** Write a program that removes all elements of a collection that match the given predicate.
119. **Converting a collection into an array:** Write a program that converts a collection into an array.
120. **Filtering a collection by `List`:** Write several solutions for filtering a collection by a `List`. Reveal the best way of doing this.
121. **Replacing elements of a `List`:** Write a program that replaces each element of a `List` with the result of applying a given operator to it.

122. **Thread-safe collections, stacks, and queues:** Write several programs that exemplify the usage of Java thread-safe collections.
123. **Breadth-first search (BFS):** Write a program that implements the BFS algorithm.
124. **Trie:** Write a program that implements a Trie data structure.
125. **Tuple:** Write a program that implements a Tuple data structure.
126. **Union Find:** Write a program that implements the Union Find algorithm.
127. **Fenwick Tree or Binary Indexed Tree:** Write a program that implements the Fenwick Tree algorithm.
128. **Bloom filter:** Write a program that implements the Bloom filter algorithm.

Solutions

The following sections describe solutions to the preceding problems. Remember that there usually isn't a single correct way to solve a particular problem. Also, remember that the explanations shown here include only the most interesting and important details needed to solve the problems. Download the example solutions to see additional details and to experiment with the programs at <https://github.com/PacktPublishing/Java-Coding-Problems>.

99. Sorting an array

Sorting an array is a common task encountered in a lot of domains/applications. It is so common that Java provides a built-in solution for sorting arrays of primitives and objects using a comparator. This solution works very well and is the preferable way to go in most of the cases. Let's take a look at the different solutions in the next section.

JDK built-in solutions

The built-in solution is named `sort()` and it comes in many different flavors in the `java.util.Arrays` class (15+ flavors).

Behind the `sort()` method, there is a performant sorting algorithm of the Quicksort type, named Dual-Pivot Quicksort.

Let's assume that we need to sort an array of integers by natural order (primitive `int`). For this, we can rely on `Arrays.sort(int[] a)`, as in the following example:

```
int[] integers = new int[]{...};
Arrays.sort(integers);
```

Sometimes, we need to sort an array of an object. Let's assume that we have a class as `Melon`:

```
public class Melon {

    private final String type;
    private final int weight;

    public Melon(String type, int weight) {
        this.type = type;
        this.weight = weight;
    }

    // getters omitted for brevity
}
```

An array of `Melon` can be sorted by ascending weight via the proper `Comparator`:

```
Melon[] melons = new Melon[] { ... };

Arrays.sort(melons, new Comparator<Melon>() {
    @Override
    public int compare(Melon melon1, Melon melon2) {
        return Integer.compare(melon1.getWeight(), melon2.getWeight());
    }
});
```

The same result can be obtained by rewriting the preceding code via a lambda expression:

```
Arrays.sort(melons, (Melon melon1, Melon melon2)
    -> Integer.compare(melon1.getWeight(), melon2.getWeight()));
```

Moreover, arrays provide a method for sorting elements in parallel, `parallelSort()`. The sorting algorithm used behind the scenes is a parallel sort-merge based on `ForkJoinPool` that breaks up the array into sub-arrays that are themselves sorted and then merged. Here is an example:

```
Arrays.parallelSort(melons, new Comparator<Melon>() {
    @Override
    public int compare(Melon melon1, Melon melon2) {
```

```
        return Integer.compare(melon1.getWeight(), melon2.getWeight());
    }
});
```

Or, via a lambda expression, we have the following example:

```
Arrays.parallelSort(melons, (Melon melon1, Melon melon2)
    -> Integer.compare(melon1.getWeight(), melon2.getWeight()));
```

The preceding examples sort an array in ascending order, but sometimes, we need to sort it by descending order. When we sort an array of `Object` and rely on a `Comparator`, we can simply multiply the result returned by `Integer.compare()` by `-1`:

```
Arrays.sort(melons, new Comparator<Melon>() {
    @Override
    public int compare(Melon melon1, Melon melon2) {
        return (-1) * Integer.compare(melon1.getWeight(),
            melon2.getWeight());
    }
});
```

Or, we can simply switch the arguments in the `compare()` method.

In the case of an array of boxed primitive types, the solution can rely on the `Collections.reverse()` method, as in the following example:

```
Integer[] integers = new Integer[] {3, 1, 5};

// 1, 3, 5
Arrays.sort(integers);

// 5, 3, 1
Arrays.sort(integers, Collections.reverseOrder());
```

Unfortunately, there is no built-in solution for sorting an array of primitives in descending order. Most commonly, if we still want to rely on `Arrays.sort()`, the solution to this problem consists of reversing the array ($O(n)$) after it is sorted in ascending order:

```
// sort ascending
Arrays.sort(integers);

// reverse array to obtain it in descending order
for (int leftHead = 0, rightHead = integers.length - 1;
    leftHead < rightHead; leftHead++, rightHead--) {
```

```
int elem = integers[leftHead];
integers[leftHead] = integers[rightHead];
integers[rightHead] = elem;
}
```

Another solution can rely on Java 8 functional style and boxing (be aware that boxing is a pretty time-consuming operation):

```
int[] descIntegers = Arrays.stream(integers)
    .boxed() //or .mapToObj(i -> i)
    .sorted((i1, i2) -> Integer.compare(i2, i1))
    .mapToInt(Integer::intValue)
    .toArray();
```

Other sorting algorithms

Well, there are plenty of other sorting algorithms out there. Each of them has pros and cons, and the best way to choose between them is to benchmark the situation specific to the application.

Let's examine some of these, as highlighted in the next section, and begin with a pretty slow algorithm.

Bubble sort

Bubble sort is a simple algorithm that basically bubbles up the elements of the array. This means that it traverses the array multiple times and swaps the adjacent elements if they are in the wrong order, as in the following diagram:

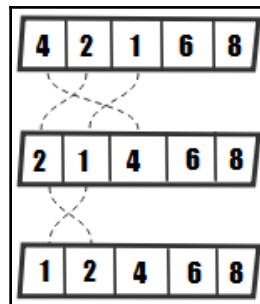

The time complexity cases are as follows: best case $O(n)$, average case $O(n^2)$, and worst case $O(n^2)$

The space complexity case is as follows: worst case $O(1)$

A utility method implementing the Bubble sort is as follows:

```
public static void bubbleSort(int[] arr) {  
  
    int n = arr.length;  
  
    for (int i = 0; i < n - 1; i++) {  
        for (int j = 0; j < n - i - 1; j++) {  
  
            if (arr[j] > arr[j + 1]) {  
                int temp = arr[j];  
                arr[j] = arr[j + 1];  
                arr[j + 1] = temp;  
            }  
        }  
    }  
}
```

There is also an optimized version of it that relies on a `while` loop. You can find it in the code bundled to this book under the name `bubbleSortOptimized()`.

As a performance comparison of time execution, for a random array of 100,000 integers, the optimized version will work around 2 seconds faster.

The preceding implementations work well for sorting arrays of primitives, but, for sorting an array of `Object`, we need to bring `Comparator` into the code, as follows:

```
public static <T> void bubbleSortWithComparator(  
    T arr[], Comparator<? super T> c) {  
  
    int n = arr.length;  
  
    for (int i = 0; i < n - 1; i++) {  
        for (int j = 0; j < n - i - 1; j++) {  
  
            if (c.compare(arr[j], arr[j + 1]) > 0) {  
                T temp = arr[j];  
                arr[j] = arr[j + 1];  
                arr[j + 1] = temp;  
            }  
        }  
    }  
}
```

Remember the `Melon` class from before? Well, we can write a `Comparator` for it by implementing the `Comparator` interface:

```
public class MelonComparator implements Comparator<Melon> {  
  
    @Override  
    public int compare(Melon o1, Melon o2) {  
        return o1.getType().compareTo(o2.getType());  
    }  
}
```

Or, in Java 8 functional style, we have the following:

```
// Ascending  
Comparator<Melon> byType = Comparator.comparing(Melon::getType);  
  
// Descending  
Comparator<Melon> byType  
    = Comparator.comparing(Melon::getType).reversed();
```

Having an array of `Melon`, the preceding `Comparator`, and the `bubbleSortWithComparator()` method in a utility class named `ArraySorts`, we can write something along the lines of the following:

```
Melon[] melons = {...};  
ArraySorts.bubbleSortWithComparator(melons, byType);
```

For brevity, the Bubble sort optimized version with a `Comparator` was skipped, but it is available in the code bundled to the book.



Bubble sort is fast when the array is almost sorted. Also, it fits well for sorting *rabbits* (big elements that are close to the start of the array) and *turtles* (small elements that are close to the end of the array). But overall, this is a slow algorithm.

Insertion sort

The insertion sort algorithm relies on a simple flow. It starts from the second element and compares it with the element before. If the element before is greater than the current element, then the algorithm swaps the elements. This process continues until the element before is smaller than the current element.

In that case, the algorithm passes to the next element in the array and repeats the flow, as in the following diagram:

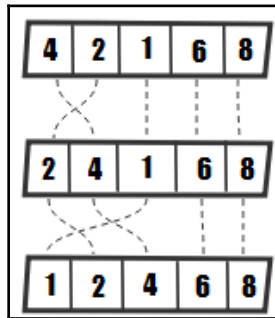

The time complexity cases are as follows: best case $O(n)$, average case $O(n^2)$, worst case $O(n^2)$

The space complexity case is as follows: worst case $O(1)$

Based on this flow, an implementation for primitive types will be as follows:

```
public static void insertionSort(int arr[]) {  
    int n = arr.length;  
    for (int i = 1; i < n; ++i) {  
        int key = arr[i];  
        int j = i - 1;  
        while (j >= 0 && arr[j] > key) {  
            arr[j + 1] = arr[j];  
            j = j - 1;  
        }  
        arr[j + 1] = key;  
    }  
}
```

For comparing an array of `Melon`, we need to bring a `Comparator` in to the implementation as follows:

```
public static <T> void insertionSortWithComparator(
    T arr[], Comparator<? super T> c) {

    int n = arr.length;

    for (int i = 1; i < n; ++i) {

        T key = arr[i];
        int j = i - 1;

        while (j >= 0 && c.compare(arr[j], key) > 0) {
            arr[j + 1] = arr[j];
            j = j - 1;
        }

        arr[j + 1] = key;
    }
}
```

Here, we have a `Comparator` that sorts the melons by type and weight written in Java 8 functional style using the `thenComparing()` method:

```
Comparator<Melon> byType = Comparator.comparing(Melon::getType)
    .thenComparing(Melon::getWeight);
```

Having an array of `Melon`, the preceding `Comparator`, and the `insertionSortWithComparator()` method in a utility class named `ArraySorts`, we can write something as follows:

```
Melon[] melons = {...};
ArraySorts.insertionSortWithComparator(melons, byType);
```



This can be fast for small and mostly sorted arrays. Also, it performs well when adding new elements to an array. It is also very memory-efficient since a single element is moved around.

Counting sort

The counting sort flow starts by calculating the minimum and the maximum element in the array. Based on the computed minimum and maximum, the algorithm defines a new array that will be used to count the unsorted elements by using the *element* as the *index*. Furthermore, this new array is modified in such a way that each *element* at each *index* stores the sum of previous counts. Finally, the sorted array is obtained from this new array.

The time complexity cases are as follows: best case $O(n + k)$, average case $O(n + k)$, worst case $O(n + k)$

The space complexity case is as follows: worst case $O(k)$



k is the number of possible values in the range.
 n is the number of elements to be sorted.

Let's consider a quick example. The initial array contains the following elements, `arr`:
 4, 2, 6, 2, 6, 8, 5:

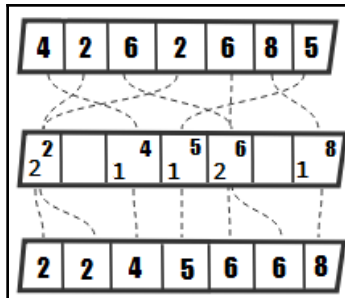

The minimum element is 2 and the maximum element is 8. The new array, `counts`, will have a size equal to the maximum minus the minimum + 1 = 8 - 2 + 1 = 7.

Counting each element will result in the following array (`counts[arr[i] - min]++`):

```
counts[2] = 1 (4); counts[0] = 2 (2); counts[4] = 2 (6);
counts[6] = 1 (8); counts[3] = 1 (5);
```

Now, we must loop this array and use it to reconstruct the sorted array as in the following implementation:

```
public static void countingSort(int[] arr) {  
  
    int min = arr[0];  
    int max = arr[0];  
  
    for (int i = 1; i < arr.length; i++) {  
        if (arr[i] < min) {  
            min = arr[i];  
        } else if (arr[i] > max) {  
            max = arr[i];  
        }  
    }  
  
    int[] counts = new int[max - min + 1];  
  
    for (int i = 0; i < arr.length; i++) {  
        counts[arr[i] - min]++;  
    }  
  
    int sortedIndex = 0;  
  
    for (int i = 0; i < counts.length; i++) {  
        while (counts[i] > 0) {  
            arr[sortedIndex++] = i + min;  
            counts[i]--;  
        }  
    }  
}
```

This is a very fast algorithm.

Heap sort

Heap sort is an algorithm that relies on a binary heap (complete binary tree).

The time complexity cases are as follows: best case $O(n \log n)$, average case $O(n \log n)$, worst case $O(n \log n)$

The space complexity case is as follows: worst case $O(1)$



Sorting elements in ascending order can be accomplished via a *Max Heap* (the parent node is always greater than, or equal to, child nodes), and in descending order via a *Min Heap* (the parent node is always smaller than, or equal to, child nodes).

At the first step, the algorithm uses the array provided to build this heap and transform it into a *Max Heap* (the heap is represented by another array). Since this is a *Max Heap*, the largest element is the root of the heap. At the next step, the root is swapped with the last element from the heap and the heap size is reduced by 1 (delete the last node from the heap). The elements that are at the top of the heap come out in sorted order. The final step consists of *heapify* (the recursive process that builds the heap in a top-down manner), and the root of the heap (reconstruct the *Max Heap*). These three steps are repeated until the heap size is greater than 1:

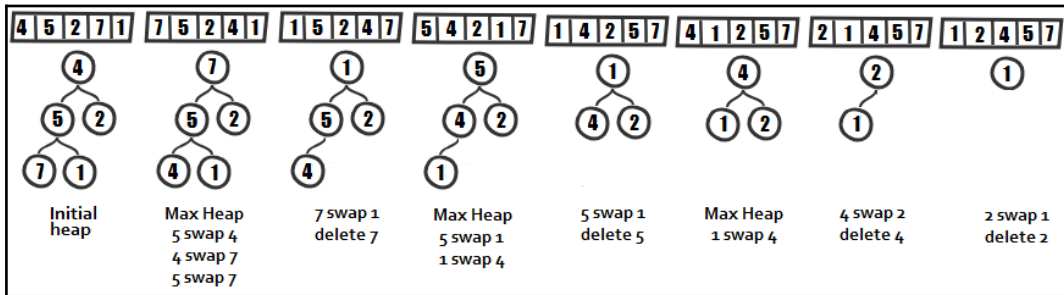

For example, let's assume the array from the preceding diagram – 4, 5, 2, 7, 1:

1. So, at the first step, we build the heap: 4, 5, 2, 7, 1.
2. We build the *Max Heap*: 7, 5, 2, 4, 1 (we swapped 5 with 4, 4 with 7, and 5 with 7).
3. Next, we swap the root (7) with the last element (1) and delete 7. Result: 1, 5, 2, 4, 7.
4. Further, we construct the *Max Heap* again: 5, 4, 2, 1 (we swapped 5 with 1 and 1 with 4).
5. We swap the root (5) with the last element (1) and delete 5. Result: 1, 4, 2, 5, 7.
6. Next, we construct the *Max Heap* again: 4, 1, 2 (we swapped 1 with 4).
7. We swap the root (4) with the last element (2) and delete 4. Result: 2, 1.
8. This is a *Max Heap*, so swap the root (2) with the last element (1) and remove 2: 1, 2, 4, 5, 7.
9. Done! There is a single element left in the heap (1).

In code lines, the preceding example can be generalized as follows:

```
public static void heapSort(int[] arr) {
    int n = arr.length;

    buildHeap(arr, n);

    while (n > 1) {
        swap(arr, 0, n - 1);
        n--;
        heapify(arr, n, 0);
    }
}

private static void buildHeap(int[] arr, int n) {
    for (int i = arr.length / 2; i >= 0; i--) {
        heapify(arr, n, i);
    }
}

private static void heapify(int[] arr, int n, int i) {
    int left = i * 2 + 1;
    int right = i * 2 + 2;
    int greater;

    if (left < n && arr[left] > arr[i]) {
        greater = left;
    } else {
        greater = i;
    }

    if (right < n && arr[right] > arr[greater]) {
        greater = right;
    }

    if (greater != i) {
        swap(arr, i, greater);
        heapify(arr, n, greater);
    }
}

private static void swap(int[] arr, int x, int y) {
    int temp = arr[x];
    arr[x] = arr[y];
    arr[y] = temp;
}
```

If we want to compare objects, then we have to bring a `Comparator` into the implementation. This solution is available in the code bundled to this book under the name `heapSortWithComparator()`.

Here, it is a `Comparator` written in Java 8 functional style that uses the `thenComparing()` and `reversed()` methods to sort the melons in descending order by type and weight:

```
Comparator<Melon> byType = Comparator.comparing(Melon::getType)
    .thenComparing(Melon::getWeight).reversed();
```

Having an array of `Melon`, the preceding `Comparator`, and the `heapSortWithComparator()` method in a utility class named `ArraySorts`, we can write something as follows:

```
Melon[] melons = {...};
ArraySorts.heapSortWithComparator(melons, byType);
```



Heap sort is pretty fast, but is not stable. For example, sorting an array that is already sorted may leave it in a different order.

We will stop our dissertation regarding sorting arrays here, but, in the code bundled to this book, there are a few more sorting algorithms available:

```

@bubbleSort(int[] arr) void
@bubbleSortWithComparator(T[] arr, Comparator<? super T> c) void
@bubbleSortOptimized(int[] arr) void
@bubbleSortOptimizedWithComparator(T[] arr, Comparator<? super T> c) void
@bucketSort(int[] arr) void
@cocktailSort(int[] arr) void
@countingSort(int[] arr) void
@cycleSort(int[] arr) void
@exchangeSort(int[] arr) void
@heapSort(int[] arr) void
@heapSortWithComparator(T[] arr, Comparator<? super T> c) void
@insertionSort(int[] arr) void
@insertionSortWithComparator(T[] arr, Comparator<? super T> c) void
@mergeSort(int[] arr) void
@pancakeSort(int[] arr) void
@quickSort(int[] arr, int left, int right) void
@quickSortWithComparator(T[] arr, int left, int right, Comparator<? super T> c) void
@radixSort(int[] arr, int radix) void
@selectionSort(int[] arr) void
@shellSort(int[] arr) void
@shuffleInt(int[] arr) void
@shuffleObj(T[] arr) void

```

There are many other algorithms dedicated to sorting arrays. Some of them are built on top of those presented here (for example, Comb sort, Cocktail sort, and Odd-even sort are flavors of Bubble sort, Bucket sort is a distribution sort commonly relying on Insertion sort, Radix sort (LSD) is a stable distribution similar to Bucket sort, and Gnome sort is a variation of Insertion sort).

Others are different approaches (for example, Quicksort implemented by the `Arrays.sort()` method, and Merge sort implemented by `Arrays.parallelSort()`).

By way of a bonus to this section, let's see how we can shuffle an array. An efficient way to accomplish this relies on the Fisher-Yates shuffle (known as the Knuth shuffle). Basically, we loop the array in reverse order and we randomly swap elements. For primitives (for example, `int`), the implementation is as follows:

```
public static void shuffleInt(int[] arr) {  
    int index;  
    Random random = new Random();  
    for (int i = arr.length - 1; i > 0; i--) {  
        index = random.nextInt(i + 1);  
        swap(arr, index, i);  
    }  
}
```

In the code bundled to this book, there is also the implementation for shuffling an array of `Object`.



Shuffling a list is pretty straightforward
via `Collections.shuffle(List<?> list)`.

100. Finding an element in an array

When we search for an element in an array, we may be interested to find out the index at which this element occurs, or only whether it is present in the array. The solutions presented in this section are materialized in the methods from the following screenshot:

containsElementObjectV1 (T[] arr, T toContain)	boolean
containsElementObjectV2 (T[] arr, T toContain, Comparator<? super T> c)	boolean
containsElementObjectV3 (T[] arr, T toContain, Comparator<? super T> c)	boolean
containsElementV1 (int[] arr, int toContain)	boolean
containsElementV2 (int[] arr, int toContain)	boolean
containsElementV3 (int[] arr, int toContain)	boolean
findIndexOfElementObjectV1 (T[] arr, T toFind)	int
findIndexOfElementObjectV2 (T[] arr, T toFind, Comparator<? super T> c)	int
findIndexOfElementObjectV3 (T[] arr, T toFind, Comparator<? super T> c)	int
findIndexOfElementV1 (int[] arr, int toFind)	int
findIndexOfElementV2 (int[] arr, int toFind)	int

Let's take a look at the different solutions in the next sections.

Check only for the presence

Let's assume the following array of integers:

```
int[] numbers = {4, 5, 1, 3, 7, 4, 1};
```

Since this is an array of primitives, the solution can simply loop the array and return to the first occurrence of the given integer, as follows:

```
public static boolean containsElement(int[] arr, int toContain) {  
  
    for (int elem: arr) {  
        if (elem == toContain) {  
            return true;  
        }  
    }  
  
    return false;  
}
```

Another solution to this problem can rely on the `Arrays.binarySearch()` methods. There are several flavors of this method, but in this case, we need this one: `int binarySearch(int[] a, int key)`. The method will search the given key in the given array and will return the corresponding index or a negative value. The only issue is that this method works only for sorted arrays; therefore, we need to sort the array beforehand:

```
public static boolean containsElement(int[] arr, int toContain) {  
  
    Arrays.sort(arr);  
    int index = Arrays.binarySearch(arr, toContain);  
  
    return (index >= 0);  
}
```



If the array is already sorted, then the preceding method can be optimized by removing the sorting step. Moreover, if the array is sorted, the preceding method may return the index where the element occurs in the array instead of a `boolean`. However, if the array is not sorted, then keep in mind that the returned index corresponds to the sorted array, not to the unsorted (initial) array. If you don't want to sort the initial array, then it is advisable to pass a clone of the array to this method. Another approach will be to clone the array inside this helper method.

In Java 8, the solution can rely on a functional style approach. A good candidate here is the `anyMatch()` method. This method returns whether any elements of the stream match the predicate provided. So, all we need to do is to convert the array to a stream, as follows:

```
public static boolean containsElement(int[] arr, int toContain) {  
  
    return Arrays.stream(arr)  
        .anyMatch(e -> e == toContain);  
}
```

For any other primitive type, it is pretty straightforward to adapt or generalize the preceding examples.

Now, let's focus on finding `Object` in arrays. Let's consider the `Melon` class:

```
public class Melon {  
  
    private final String type;  
    private final int weight;  
  
    // constructor, getters, equals() and hashCode() skipped for brevity  
}
```

Next, let's consider an array of `Melon`:

```
Melon[] melons = new Melon[] {new Melon("Crenshaw", 2000),  
    new Melon("Gac", 1200), new Melon("Bitter", 2200)  
};
```

Now, let's assume that we want to find the `Gac` melon of 1,200 g in this array. A solution can rely on the `equals()` method, which is used to determine the equality of two objects:

```
public static <T> boolean  
    containsElementObject(T[] arr, T toContain) {  
  
    for (T elem: arr) {  
        if (elem.equals(toContain)) {  
            return true;  
        }  
    }  
  
    return false;  
}
```



Similarly, we can rely on `Arrays.asList(arr).contains(find)`. Basically, convert the array to a `List` and call the `contains()` method. Behind the scenes, this method uses the `equals()` contract.

If this method lives in a utility class named `ArraySearch`, then the following call will return `true`:

```
// true  
boolean found = ArraySearch.containsElementObject(  
    melons, new Melon("Gac", 1200));
```

This solution works fine as long as we want to rely on the `equals()` contract. But we may consider that our melon is present in the array if its name occurs (Gac), or if its weight occurs (1,200). For such cases, it is more practical to rely on a `Comparator`:

```
public static <T> boolean containsElementObject(
    T[] arr, T toContain, Comparator<? super T> c) {

    for (T elem: arr) {
        if (c.compare(elem, toContain) == 0) {
            return true;
        }
    }

    return false;
}
```

Now, a `Comparator` that takes into account only the type of melons can be written as follows:

```
Comparator<Melon> byType = Comparator.comparing(Melon::getType);
```

Since the `Comparator` ignores the weight of the melon (there is no melon of 1,205 grams), the following invocation will return `true`:

```
// true
boolean found = ArraySearch.containsElementObject(
    melons, new Melon("Gac", 1205), byType);
```

Another approach relies on another flavor of `binarySearch()`. The `Arrays` class provides a `binarySearch()` method that gets a `Comparator`, `<T> int binarySearch(T[] a, T key, Comparator<? super T> c)`. This means that we can use it as follows:

```
public static <T> boolean containsElementObject(
    T[] arr, T toContain, Comparator<? super T> c) {

    Arrays.sort(arr, c);
    int index = Arrays.binarySearch(arr, toContain, c);

    return (index >= 0);
}
```



If the initial array state should remain unmodified, then it is advisable to pass a clone of the array to this method. Another approach would be to clone the array inside this helper method.

Now, a `Comparator` that takes into account only the weight of melons can be written as follows:

```
Comparator<Melon> byWeight = Comparator.comparing(Melon::getWeight);
```

Since the `Comparator` ignores the type of melon (there is no melon of the Honeydew type), the following invocation will return `true`:

```
// true
boolean found = ArraySearch.containsElementObject(
    melons, new Melon("Honeydew", 1200), byWeight);
```

Check only for the first index

For an array of primitives, the simplest implementation speaks for itself:

```
public static int findIndexOfElement(int[] arr, int toFind) {

    for (int i = 0; i < arr.length; i++) {
        if (arr[i] == toFind) {
            return i;
        }
    }

    return -1;
}
```

Relying on Java 8 functional style, we can try to loop the array and filter the elements that match the given element. In the end, simply return the first found element:

```
public static int findIndexOfElement(int[] arr, int toFind) {

    return IntStream.range(0, arr.length)
        .filter(i -> toFind == arr[i])
        .findFirst()
        .orElse(-1);
}
```

For an array of `Object`, there are at least three approaches. In the first instance, we can rely on the `equals()` contract:

```
public static <T> int findIndexOfElementObject(T[] arr, T toFind) {

    for (int i = 0; i < arr.length; i++) {
        if (arr[i].equals(toFind)) {
            return i;
        }
    }
}
```

```

    }
}

return -1;
}

```



Similarly, we can rely on `Arrays.asList(arr).indexOf(find)`. Basically, convert the array to a `List` and call the `indexOf()` method. Behind the scenes, this method uses the `equals()` contract.

Secondly, we can rely on a `Comparator`:

```

public static <T> int findIndexOfElementObject(
    T[] arr, T toFind, Comparator<? super T> c) {

    for (int i = 0; i < arr.length; i++) {
        if (c.compare(arr[i], toFind) == 0) {
            return i;
        }
    }

    return -1;
}

```

And thirdly, we can rely on Java 8 functional style and a `Comparator`:

```

public static <T> int findIndexOfElementObject(
    T[] arr, T toFind, Comparator<? super T> c) {

    return IntStream.range(0, arr.length)
        .filter(i -> c.compare(toFind, arr[i]) == 0)
        .findFirst()
        .orElse(-1);
}

```

101. Checking whether two arrays are equal or mismatches

Two arrays of primitives are equal if they contain the same number of elements, and all corresponding pairs of elements in the two arrays are equal.

The solutions to these two problems rely on the `Arrays` utility class. The following sections give the solutions to these problems.

Checking whether two arrays are equal

Checking whether two arrays are equal can be easily accomplished via the `Arrays.equals()` method. This flag method comes in many flavors for primitive types, `Object`, and generics. It also supports comparators.

Let's consider the following three arrays of integers:

```
int[] integers1 = {3, 4, 5, 6, 1, 5};
int[] integers2 = {3, 4, 5, 6, 1, 5};
int[] integers3 = {3, 4, 5, 6, 1, 3};
```

Now, let's check whether `integers1` is equal to `integers2`, and whether `integers1` is equal to `integers3`. This is very simple:

```
boolean i12 = Arrays.equals(integers1, integers2); // true
boolean i13 = Arrays.equals(integers1, integers3); // false
```

The preceding examples check whether two arrays are equal, but we can check whether two segments (or ranges) of the arrays are equal as well via the `boolean equals(int[] a, int aFromIndex, int aToIndex, int[] b, int bFromIndex, int bToIndex)` method. So, we demarcate the segment of the first array via the range `[aFromIndex, aToIndex)` and the segment of the second array via the range `[bFromIndex, bToIndex)`:

```
// true
boolean is13 = Arrays.equals(integers1, 1, 4, integers3, 1, 4);
```

Now, let's assume three arrays of `Melon`:

```
public class Melon {

    private final String type;
    private final int weight;

    public Melon(String type, int weight) {
        this.type = type;
        this.weight = weight;
    }

    // getters, equals() and hashCode() omitted for brevity
}

Melon[] melons1 = {
    new Melon("Horned", 1500), new Melon("Gac", 1000)
};
```

```
Melon[] melons2 = {
    new Melon("Horned", 1500), new Melon("Gac", 1000)
};

Melon[] melons3 = {
    new Melon("Hami", 1500), new Melon("Gac", 1000)
};
```

Two arrays of `Object` are considered equal based on the `equals()` contract, or based on the specified `Comparator`. We can easily check whether `melons1` is equal to `melons2`, and whether `melons1` is equal to `melons3` as follows:

```
boolean m12 = Arrays.equals(melons1, melons2); // true
boolean m13 = Arrays.equals(melons1, melons3); // false
```

And, in an explicit range, use `boolean equals(Object[] a, int aFromIndex, int aToIndex, Object[] b, int bFromIndex, int bToIndex)`:

```
boolean ms13 = Arrays.equals(melons1, 1, 2, melons3, 1, 2); // false
```

While these examples rely on the `Melon.equals()` implementation, the following two examples rely on the following two `Comparator`:

```
Comparator<Melon> byType = Comparator.comparing(Melon::getType);
Comparator<Melon> byWeight = Comparator.comparing(Melon::getWeight);
```

Using the `boolean equals(T[] a, T[] a2, Comparator<? super T> cmp)`, we have the following:

```
boolean mw13 = Arrays.equals(melons1, melons3, byWeight); // true
boolean mt13 = Arrays.equals(melons1, melons3, byType); // false
```

And, in an explicit range, using `Comparator, <T> boolean equals(T[] a, int aFromIndex, int aToIndex, T[] b, int bFromIndex, int bToIndex, Comparator<? super T> cmp)`, we have the following:

```
// true
boolean mrt13 = Arrays.equals(melons1, 1, 2, melons3, 1, 2, byType);
```

Checking whether two arrays contain a mismatch

If two arrays are equal, then a mismatch should return `-1`. But if two arrays are not equal, then a mismatch should return the index of the first mismatch between the two given arrays. In order to resolve this problem, we can rely on JDK 9 `Arrays.mismatch()` methods.

For example, we can check for mismatches between `integers1` and `integers2` as follows:

```
int mi12 = Arrays.mismatch(integers1, integers2); // -1
```

The result is `-1`, since `integers1` and `integers2` are equal. But if we check for `integers1` and `integers3`, we receive the value `5`, which is the index of the first mismatch between these two:

```
int mi13 = Arrays.mismatch(integers1, integers3); // 5
```



If the given arrays have different lengths and the smaller one is a prefix for the larger one, then the returned mismatch is the length of the smaller array.

For arrays of `Object`, there are dedicated `mismatch()` methods as well. These methods count on the `equals()` contract or on the given `Comparator`. We can check whether there is a mismatch between `melons1` and `melons2` as follows:

```
int mm12 = Arrays.mismatch(melons1, melons2); // -1
```

If the mismatch occurs on the first index, then the returned value is `0`. This is happening in the case of `melons1` and `melons3`:

```
int mm13 = Arrays.mismatch(melons1, melons3); // 0
```

As in the case of `Arrays.equals()`, we can check mismatches in an explicit range using a `Comparator`:

```
// range [1, 2), return -1
int mms13 = Arrays.mismatch(melons1, 1, 2, melons3, 1, 2);

// Comparator by melon's weights, return -1
int mmw13 = Arrays.mismatch(melons1, melons3, byWeight);

// Comparator by melon's types, return 0
int mmt13 = Arrays.mismatch(melons1, melons3, byType);

// range [1,2) and Comparator by melon's types, return -1
int mmrt13 = Arrays.mismatch(melons1, 1, 2, melons3, 1, 2, byType);
```

102. Comparing two arrays lexicographically

Starting with JDK 9, we can compare two arrays lexicographically via the `Arrays.compare()` methods. Since there is no need to reinvent the wheel, just upgrade to JDK 9 and let's dive into it.

A lexicographic comparison of two arrays may return the following:

- 0, if the given arrays are equal and contain the same elements in the same order
- A value less than 0 if the first array is lexicographically less than the second array
- A value greater than 0 if the first array is lexicographically greater than the second array

If the first array length is less than the second array length, then the first array is lexicographically less than the second array. If the arrays have the same length, contain primitives, and share a common prefix, then the lexicographic comparison is the result of comparing two elements, precisely as `Integer.compare(int, int)`, `Boolean.compare(boolean, boolean)`, `Byte.compare(byte, byte)`, and so on. If the arrays contain `Object`, then the lexicographic comparison is relying on the given `Comparator` or on the `Comparable` implementation.

First, let's consider the following arrays of primitives:

```
int[] integers1 = {3, 4, 5, 6, 1, 5};
int[] integers2 = {3, 4, 5, 6, 1, 5};
int[] integers3 = {3, 4, 5, 6, 1, 3};
```

Now, `integers1` is lexicographically equal to `integers2` because they are equal and contain the same elements in the same order, `int compare(int[] a, int[] b)`:

```
int i12 = Arrays.compare(integers1, integers2); // 0
```

However, `integers1` is lexicographically greater than `integers3`, since they share the same prefix (3, 4, 5, 6, 1), but for the last element, `Integer.compare(5, 3)` returns a value greater than 0 since 5 is greater than 3:

```
int i13 = Arrays.compare(integers1, integers3); // 1
```

A lexicographical comparison can be accomplished on different ranges of the arrays. For example, the following example compares `integers1` and `integers3` in the range `[3, 6)` via the `int compare(int[] a, int aFromIndex, int aToIndex, int[] b, int bFromIndex, int bToIndex)` method:

```
int is13 = Arrays.compare(integers1, 3, 6, integers3, 3, 6); // 1
```

For arrays of `Object`, the `Arrays` class also provides a set of dedicated `compare()` methods. Remember the `Melon` class? Well, in order to compare two arrays of `Melon` without an explicit `Comparator`, we need to implement the `Comparable` interface and implement the `compareTo()` method. Let's assume that we are relying on `melon` weights as follows:

```
public class Melon implements Comparable {

    private final String type;
    private final int weight;

    @Override
    public int compareTo(Object o) {
        Melon m = (Melon) o;

        return Integer.compare(this.getWeight(), m.getWeight());
    }

    // constructor, getters, equals() and hashCode() omitted for brevity
}
```



Note that the lexicographic comparison of arrays of `Object` doesn't rely on `equals()`. It requires an explicit `Comparator` or `Comparable` elements.

Let's assume the following arrays of `Melon`:

```
Melon[] melons1 = {new Melon("Horned", 1500), new Melon("Gac", 1000)};
Melon[] melons2 = {new Melon("Horned", 1500), new Melon("Gac", 1000)};
Melon[] melons3 = {new Melon("Hami", 1600), new Melon("Gac", 800)};
```

And, let's compare lexicographically `melons1` with `melons2` via `<T extends Comparable<? super T>> int compare(T[] a, T[] b):`

```
int m12 = Arrays.compare(melons1, melons2); // 0
```

Since `melons1` and `melons2` are identical, the result is 0.

Now, let's do the same thing with `melons1` and `melons3`. This time, the result will be negative, which means that `melons1` is lexicographically less than `melons3`. This is true since, at index 0, the Horned melon has a weight of 1,500 g, which is less than the weight of the Hami melon, which is 1,600 g:

```
int m13 = Arrays.compare(melons1, melons3); // -1
```

We can perform the comparison in different ranges of the arrays via the `<T extends Comparable<? super T>> int compare(T[] a, int aFromIndex, int aToIndex, T[] b, int bFromIndex, int bToIndex)` method. For example, in the common range [1, 2), `melons1` is lexicographically greater than `melons2`, since the weight of Gac is 1,000g in `melons1` and 800g in `melons3`:

```
int ms13 = Arrays.compare(melons1, 1, 2, melons3, 1, 2); // 1
```

If we don't want to rely on Comparable elements (implement Comparable), we can pass in a Comparator via the `<T> int compare(T[] a, T[] b, Comparator<? super T> cmp)` method:

```
Comparator<Melon> byType = Comparator.comparing(Melon::getType);  
int mt13 = Arrays.compare(melons1, melons3, byType); // 14
```

Using ranges is also possible by means of `<T> int compare(T[] a, int aFromIndex, int aToIndex, T[] b, int bFromIndex, int bToIndex, Comparator<? super T> cmp)`:

```
int mrt13 = Arrays.compare(melons1, 1, 2, melons3, 1, 2, byType); // 0
```



If the arrays of numbers should be treated unsigned, then rely on the bunch of `Arrays.compareUnsigned()` methods, which are available for `byte`, `short`, `int`, and `long`.

To compare two strings lexicographically, rely on `String.compareTo()` and `int compareTo(String anotherString)`.

103. Creating a Stream from an array

Once we create a `Stream` from an array, we have access to all the Stream API goodies. Therefore, this is a handy operation that is important to have in our tool belt.

Let's start with an array of strings (can be other objects as well):

```
String[] arr = {"One", "Two", "Three", "Four", "Five"};
```

The easiest way to create `Stream` from this `String[]` array is to rely on the `Arrays.stream()` method available starting with JDK 8:

```
Stream<String> stream = Arrays.stream(arr);
```

Or, if we need a stream from a sub-array, then simply add the range as arguments. For example, let's create a `Stream` from the elements that range between (0,2), which are one and two:

```
Stream<String> stream = Arrays.stream(arr, 0, 2);
```

The same cases, but passing through a `List`, can be written as follows:

```
Stream<String> stream = Arrays.asList(arr).stream();  
Stream<String> stream = Arrays.asList(arr).subList(0, 2).stream();
```

Another solution relies on `Stream.of()` methods, as in the following straightforward examples:

```
Stream<String> stream = Stream.of(arr);  
Stream<String> stream = Stream.of("One", "Two", "Three");
```

Creating an array from a `Stream` can be accomplished via the `Stream.toArray()` method. For example, a simple approach appears as follows:

```
String[] array = stream.toArray(String[]::new);
```

In addition, let's consider an array of primitives:

```
int[] integers = {2, 3, 4, 1};
```

In such a case, the `Arrays.stream()` method can help again, the only difference being that the returned result is of the `IntStream` type (this is the `int` primitive specialization of `Stream`):

```
IntStream intStream = Arrays.stream(integers);
```

But the `IntStream` class also provides an `of()` method that can be used as follows:

```
IntStream intStream = IntStream.of(integers);
```

Sometimes, we need to define a `Stream` of sequentially ordered integers with an incremental step of 1. Moreover, the size of the `Stream` should be equal to the size of an array. Especially for such cases, the `IntStream` method provides two methods—`range(int inclusive, int exclusive)` and `rangeClosed(int startInclusive, int endInclusive)`:

```
IntStream intStream = IntStream.range(0, integers.length);  
IntStream intStream = IntStream.rangeClosed(0, integers.length);
```

Creating an array from a `Stream` of integers can be accomplished via the `Stream.toArray()` method. For example, a simple approach appears as follows:

```
int[] intArray = intStream.toArray();  
  
// for boxed integers  
int[] intArray = intStream.mapToInt(i -> i).toArray();
```



Besides the `IntStream` specialization of `Stream`, JDK 8 provides specializations for `long` (`LongStream`) and `double` (`DoubleStream`).

104. Minimum, maximum, and average of an array

Computing the minimum, maximum, and average values of an array is a common task. Let's look at several approaches to solving this problem in functional style and imperative programming.

Computing maximum and minimum

Computing the maximum value of an array of numbers can be implemented by looping the array and tracking the maximum value via a comparison with each element of the array. In terms of lines of code, this can be written as follows:

```
public static int max(int[] arr) {  
  
    int max = arr[0];
```



```
    for (int elem: arr) {
        if (elem > max) {
            max = elem;
        }
    }

    return max;
}
```

A little pinch in readability here may entail using the `Math.max()` method instead of an `if` statement:

```
...
max = Math.max(max, elem);
...
```

Let's suppose that we have the following array of integers and a utility class named `MathArrays` that contains the preceding methods:

```
int[] integers = {2, 3, 4, 1, -4, 6, 2};
```

The maximum of this array can easily be obtained as follows:

```
int maxInt = MathArrays.max(integers); // 6
```

In Java 8 functional style, the solution to this problem entails a single line of code:

```
int maxInt = Arrays.stream(integers).max().getAsInt();
```



In the functional-style approach, the `max()` method returns an `OptionalInt`. Similarly, we have `OptionalLong` and `OptionalDouble`.

Furthermore, let's assume an array of objects, in this case, an array of `Melon`:

```
Melon[] melons = {
    new Melon("Horned", 1500), new Melon("Gac", 2200),
    new Melon("Hami", 1600), new Melon("Gac", 2100)
};
```

```
public class Melon implements Comparable {

    private final String type;
    private final int weight;

    @Override
    public int compareTo(Object o) {
```

```
Melon m = (Melon) o;

return Integer.compare(this.getWeight(), m.getWeight());
}

// constructor, getters, equals() and hashCode() omitted for brevity
}
```

It is obvious that our `max()` methods defined earlier cannot be used in this case, but the logical principle remains the same. This time, the implementation should rely on `Comparable` or `Comparator`. The implementation based on `Comparable` can be as follows:

```
public static <T extends Comparable<T>> T max(T[] arr) {

    T max = arr[0];

    for (T elem : arr) {
        if (elem.compareTo(max) > 0) {
            max = elem;
        }
    }

    return max;
}
```

Check the `Melon.compareTo()` method and note that our implementation will compare the weights of melons. Therefore, we can easily find the heaviest melon from our array as follows:

```
Melon maxMelon = MathArrays.max(melons); // Gac(2200g)
```

And the implementation relying on `Comparator` can be written as follows:

```
public static <T> T max(T[] arr, Comparator<? super T> c) {

    T max = arr[0];

    for (T elem: arr) {
        if (c.compare(elem, max) > 0) {
            max = elem;
        }
    }

    return max;
}
```

And, if we define a `Comparator` according to the type of melon, we have the following:

```
Comparator<Melon> byType = Comparator.comparing(Melon::getType);
```

Then, we get the maximum melon conforming to the lexicographical comparison of strings:

```
Melon maxMelon = MathArrays.max(melons, byType); // Horned(1500g)
```

In Java 8 functional style, the solution to this problem entails a single line of code:

```
Melon maxMelon = Arrays.stream(melons).max(byType).orElseThrow();
```

Computing average

Computing the average value of an array of numbers (in this case integers) can be implemented in two simple steps:

1. Compute the sum of the elements from the array.
2. Divide this sum by the length of the array.

In code lines, we have the following:

```
public static double average(int[] arr) {  
    return sum(arr) / arr.length;  
}  
  
public static double sum(int[] arr) {  
    double sum = 0;  
  
    for (int elem: arr) {  
        sum += elem;  
    }  
  
    return sum;  
}
```

The average of our integers array is 2.0:

```
double avg = MathArrays.average(integers);
```

In Java 8 functional style, the solution to this problem entails a single line of code:

```
double avg = Arrays.stream(integers).average().getAsDouble();
```



For third-party library support, please consider Apache Common Lang (`ArrayUtil`) and Guava's `Chars`, `Ints`, `Longs`, and other classes.

105. Reversing an array

There are several solutions to this problem. Some of them mutate the initial array, while others just return a new array.

Let's assume the following array of integers:

```
int[] integers = {-1, 2, 3, 1, 4, 5, 3, 2, 22};
```

Let's start with a simple implementation that swaps the first element of the array with the last element, the second element with the penultimate element, and so on:

```
public static void reverse(int[] arr) {  
  
    for (int leftHead = 0, rightHead = arr.length - 1;  
         leftHead < rightHead; leftHead++, rightHead--) {  
  
        int elem = arr[leftHead];  
        arr[leftHead] = arr[rightHead];  
        arr[rightHead] = elem;  
    }  
}
```

The preceding solution mutates the given array and this is not always the desired behavior. Of course, we can modify it to return a new array, or we can rely on Java 8 functional style as follows:

```
// 22, 2, 3, 5, 4, 1, 3, 2, -1  
int[] reversed = IntStream.rangeClosed(1, integers.length)  
    .map(i -> integers[integers.length - i]).toArray();
```

Now, let's reverse an array of objects. For this, let's consider the `Melon` class:

```
public class Melon {  
  
    private final String type;  
    private final int weight;
```

```
    // constructor, getters, equals(), hashCode() omitted for brevity
}
```

Also, let's consider an array of `Melon`:

```
Melon[] melons = {
    new Melon("Crenshaw", 2000),
    new Melon("Gac", 1200),
    new Melon("Bitter", 2200)
};
```

The first solution entails using generics to shape the implementation that swaps the first element of the array with the last element, the second element with the second last element, and so on:

```
public static <T> void reverse(T[] arr) {

    for (int leftHead = 0, rightHead = arr.length - 1;
         leftHead < rightHead; leftHead++, rightHead--) {

        T elem = arr[leftHead];
        arr[leftHead] = arr[rightHead];
        arr[rightHead] = elem;
    }
}
```

Since our array contains objects, we can rely on `Collections.reverse()` as well. We just need to convert the array to a `List` via the `Arrays.asList()` method:

```
// Bitter(2200g), Gac(1200g), Crenshaw(2000g)
Collections.reverse(Arrays.asList(melons));
```

The preceding two solutions mutate the elements of the array. Java 8 functional style can help us to avoid this mutation:

```
// Bitter(2200g), Gac(1200g), Crenshaw(2000g)
Melon[] reversed = IntStream.rangeClosed(1, melons.length)
    .mapToObj(i -> melons[melons.length - i])
    .toArray(Melon[]:new);
```



For third-party library support, please consider Apache Common Lang (`ArrayUtils.reverse()`) and Guava's `Lists` class.

106. Filling and setting an array

Sometimes, we need to fill up an array with a fixed value. For example, we may want to fill up an array of integers with the value 1. The simplest way to accomplish this relies on a `for` statement as follows:

```
int[] arr = new int[10];

// 1, 1, 1, 1, 1, 1, 1, 1, 1, 1
for (int i = 0; i < arr.length; i++) {
    arr[i] = 1;
}
```

But we can reduce this code to a single line of code by means of the `Arrays.fill()` methods. This method comes in different flavors for primitives and for objects. The preceding code can be rewritten via `Arrays.fill(int[] a, int val)` as follows:

```
// 1, 1, 1, 1, 1, 1, 1, 1, 1, 1
Arrays.fill(arr, 1);
```



`Arrays.fill()` also come with flavors for filling up just a segment/range of an array. For integers, this method is `fill(int[] a, int fromIndexInclusive, int toIndexExclusive, int val)`.

Now, how about applying a generator function to compute each element of the array? For example, let's assume that we want to compute each element as the previous one plus 1. The simplest approach will again rely on a `for` statement as follows:

```
// 1, 2, 3, 4, 5, 6, 7, 8, 9, 10
for (int i = 1; i < arr.length; i++) {
    arr[i] = arr[i - 1] + 1;
}
```

The preceding code has to be modified accordingly depending on the computations that need to be applied to each element.

For such tasks, JDK 8 comes with a bunch of `Arrays.setAll()` and `Arrays.parallelSetAll()` methods. For example, the preceding snippet of code can be rewritten via `setAll(int[] array, IntUnaryOperator generator)` as follows:

```
// 1, 2, 3, 4, 5, 6, 7, 8, 9, 10
Arrays.setAll(arr, t -> {
    if (t == 0) {
```

```
    return arr[t];
  } else {
    return arr[t - 1] + 1;
  }
});
```



Besides this method, we also have `setAll(double[] array, IntToDoubleFunction generator)`, `setAll(long[] array, IntToLongFunction generator)`, and `setAll(T[] array, IntFunction<? extends T> generator)`.

Depending on the generator function, this task can be accomplished in parallel or not. For example, the preceding generator function cannot be applied in parallel since each element depends on the value of the preceding element. Trying to apply this generator function in parallel will lead to incorrect and unstable results.

But let's assume that we want to take the preceding array (1, 2, 3, 4, 5, 6, 7, 8, 9, 10) and multiply each even value by itself and decrease each odd value by 1. Since each element can be computed individually, we can empower a parallel process in this case. This is the perfect job for `Arrays.parallelSetAll()` methods. Basically, these methods are meant to parallelize `Arrays.setAll()` methods.

Let's now apply `parallelSetAll(int[] array, IntUnaryOperator generator)` to this array:

```
// 0, 4, 2, 16, 4, 36, 6, 64, 8, 100
Arrays.parallelSetAll(arr, t -> {
    if (arr[t] % 2 == 0) {
        return arr[t] * arr[t];
    } else {
        return arr[t] - 1;
    }
});
```



For each `Arrays.setAll()` method, there is an `Arrays.parallelSetAll()` method.

As a bonus, `Arrays` come with a set of methods named `parallelPrefix()`. These methods are useful for applying a mathematical function to the elements of the array, both cumulatively and concurrently.

For example, if we want to compute each element of the array as the sum of the preceding elements, then we can do it as follows:

```
// 0, 4, 6, 22, 26, 62, 68, 132, 140, 240
Arrays.parallelPrefix(arr, (t, q) -> t + q);
```

107. Next Greater Element

NGE is a classic problem that involves arrays.

Basically, having an array and an element from it, e , we want to fetch the next (right-hand side) element greater than e . For example, let's assume the following array:

```
int[] integers = {1, 2, 3, 4, 12, 2, 1, 4};
```

Fetching the NGE for each element will result in the following pairs (-1 is interpreted as no element from the right-hand side is greater than the current one):

```
1 : 2   2 : 3   3 : 4   4 : 12   12 : -1   2 : 4   1 : 4   4 : -1
```

A simple solution to this problem will be looping the array for each element until a greater element is found or there are no more elements to check. If we just want to print the pairs on the screen, then we can write a trivial code such as the following:

```
public static void println(int[] arr) {
    int nge;
    int n = arr.length;

    for (int i = 0; i < n; i++) {
        nge = -1;
        for (int j = i + 1; j < n; j++) {
            if (arr[i] < arr[j]) {
                nge = arr[j];
                break;
            }
        }

        System.out.println(arr[i] + " : " + nge);
    }
}
```

Another solution relies on a stack. Mainly, we push elements in the stack until the currently processed element is greater than the top element in the stack. When this is happening, we pop that element. The solution is available in the code bundled to this book.

108. Changing array size

Increasing the size of an array is not straightforward. This is because Java arrays are of a fixed size and we cannot modify their size. The solution to this problem entails creating a new array of the requisite size and copying all the values from the original array to this one. This can be done via the `Arrays.copyOf()` method or via `System.arraycopy()` (used internally by `Arrays.copyOf()`).

For an array of primitives (for example, `int`), we can add the value to an array after increasing its size by 1 as follows:

```
public static int[] add(int[] arr, int item) {  
  
    int[] newArr = Arrays.copyOf(arr, arr.length + 1);  
    newArr[newArr.length - 1] = item;  
  
    return newArr;  
}
```

Or, we can remove the last value as follows:

```
public static int[] remove(int[] arr) {  
  
    int[] newArr = Arrays.copyOf(arr, arr.length - 1);  
  
    return newArr;  
}
```

Alternatively, we can resize the array with the given length as follows:

```
public static int[] resize(int[] arr, int length) {  
  
    int[] newArr = Arrays.copyOf(arr, arr.length + length);  
  
    return newArr;  
}
```

The code bundled to this book also contains the `System.arraycopy()` alternatives. Moreover, it contains the implementations for generic arrays. The signatures are as follows:

```
public static <T> T[] addObject(T[] arr, T item);
public static <T> T[] removeObject(T[] arr);
public static <T> T[] resize(T[] arr, int length);
```

Being in a favorable context, let's bring a related topic into the discussion: how to create a generic array in Java. The following will not work:

```
T[] arr = new T[arr_size]; // causes generic array creation error
```

There are several approaches, but Java uses the following code in `copyOf(T[] original, int newLength)`:

```
// newType is original.getClass()
T[] copy = ((Object) newType == (Object) Object[].class) ?
    (T[]) new Object[newLength] :
    (T[]) Array.newInstance(newType.getComponentType(), newLength);
```

109. Creating unmodifiable/immutable collections

Creating unmodifiable/immutable collections in Java can easily be accomplished by means of the `Collections.unmodifiableFoo()` method (for example, `unmodifiableList()`) and, starting with JDK 9, via the set of `of()` methods from `List`, `Set`, `Map`, and other interfaces.

Furthermore, we will use these methods in a bunch of examples to obtain unmodifiable/immutable collections. The main goal is to determine whether each defined collection is unmodifiable or immutable.



Before reading this section, it is advisable to read the problems dedicated to immutability from *Chapter 2, Objects, Immutability, and Switch Expressions*.

OK. In the case of primitives, it is pretty simple. For example, we can create an immutable `List` of integers as follows:

```
private static final List<Integer> LIST
    = Collections.unmodifiableList(Arrays.asList(1, 2, 3, 4, 5));

private static final List<Integer> LIST = List.of(1, 2, 3, 4, 5);
```

For the next examples, let's consider the following mutable class:

```
public class MutableMelon {

    private String type;
    private int weight;

    // constructor omitted for brevity

    public void setType(String type) {
        this.type = type;
    }

    public void setWeight(int weight) {
        this.weight = weight;
    }

    // getters, equals() and hashCode() omitted for brevity
}
```

Problem 1 (Collections.unmodifiableList())

Let's create a list of `MutableMelon` via the `Collections.unmodifiableList()` method:

```
// Crenshaw(2000g), Gac(1200g)
private final MutableMelon melon1
    = new MutableMelon("Crenshaw", 2000);
private final MutableMelon melon2
    = new MutableMelon("Gac", 1200);

private final List<MutableMelon> list
    = Collections.unmodifiableList(Arrays.asList(melon1, melon2));
```

So, is `list` unmodifiable or immutable? The answer is unmodifiable. While mutator methods will throw `UnsupportedOperationException`, the underlying `melon1` and `melon2` are mutable. For example, let's set the weights of our melons to 0:

```
melon1.setWeight(0);
melon2.setWeight(0);
```

Now, the list will reveal the following melons (so the list was mutated):

```
Crenshaw(0g), Gac(0g)
```

Problem 2 (Arrays.asList())

Let's create a list of `MutableMelon` by hardcoding the instances directly in `Arrays.asList()`:

```
private final List<MutableMelon> list
    = Collections.unmodifiableList(Arrays.asList(
        new MutableMelon("Crenshaw", 2000),
        new MutableMelon("Gac", 1200)));
```

So, is the list unmodifiable or immutable? The answer is unmodifiable. While mutator methods will throw `UnsupportedOperationException`, the hardcoded instances can be accessed via the `List.get()` method. Once they can be accessed, they can be mutated:

```
MutableMelon melon1 = list.get(0);
MutableMelon melon2 = list.get(1);

melon1.setWeight(0);
melon2.setWeight(0);
```

Now, the list will reveal the following melons (so the list was mutated):

```
Crenshaw(0g), Gac(0g)
```

Problem 3 (Collections.unmodifiableList() and static block)

Let's create a list of `MutableMelon` via the `Collections.unmodifiableList()` method and a static block:

```
private static final List<MutableMelon> list;
static {
```

```
final MutableMelon melon1 = new MutableMelon("Crenshaw", 2000);
final MutableMelon melon2 = new MutableMelon("Gac", 1200);

list = Collections.unmodifiableList(Arrays.asList(melon1, melon2));
}
```

So, is the list unmodifiable or immutable? The answer is unmodifiable. While mutator methods will throw `UnsupportedOperationException`, the hardcoded instances can still be accessed via the `List.get()` method. Once they can be accessed, they can be mutated:

```
MutableMelon melon1l = list.get(0);
MutableMelon melon2l = list.get(1);

melon1l.setWeight(0);
melon2l.setWeight(0);
```

Now, the list will reveal the following melons (so the list was mutated):

```
Crenshaw(0g), Gac(0g)
```

Problem 4 (List.of())

Let's create a list of `MutableMelon` via `List.of()`:

```
private final MutableMelon melon1
    = new MutableMelon("Crenshaw", 2000);
private final MutableMelon melon2
    = new MutableMelon("Gac", 1200);

private final List<MutableMelon> list = List.of(melon1, melon2);
```

So, is the list unmodifiable or immutable? The answer is unmodifiable. While mutator methods will throw `UnsupportedOperationException`, the hardcoded instances can still be accessed via the `List.get()` method. Once they can be accessed, they can be mutated:

```
MutableMelon melon1l = list.get(0);
MutableMelon melon2l = list.get(1);

melon1l.setWeight(0);
melon2l.setWeight(0);
```

Now, the list will reveal the following melons (so the list was mutated):

```
Crenshaw(0g), Gac(0g)
```

For the next examples, let's consider the following immutable class:

```
public final class ImmutableMelon {  
  
    private final String type;  
    private final int weight;  
  
    // constructor, getters, equals() and hashCode() omitted for brevity  
}
```

Problem 5 (immutable)

Let's now create a list of `ImmutableMelon` via `Collections.unmodifiableList()` and the `List.of()` methods:

```
private static final ImmutableMelon MELON_1  
    = new ImmutableMelon("Crenshaw", 2000);  
private static final ImmutableMelon MELON_2  
    = new ImmutableMelon("Gac", 1200);  
  
private static final List<ImmutableMelon> LIST  
    = Collections.unmodifiableList(Arrays.asList(MELON_1, MELON_2));  
private static final List<ImmutableMelon> LIST  
    = List.of(MELON_1, MELON_2);
```

So, is the list unmodifiable or immutable? The answer is immutable. Mutator methods will throw `UnsupportedOperationException`, and we cannot mutate the instances of `ImmutableMelon`.

As a rule of thumb, a collection is unmodifiable if it is defined via `unmodifiableFoo()` or `of()` methods and contains mutable data, and it is immutable if it is unmodifiable and contains immutable data (including primitives).



Pay attention to the fact that impenetrable immutability should take into consideration Java Reflection API and similar APIs that have supplementary powers in manipulating code.

For third-party library support, please consider Apache Common Collection, `UnmodifiableList` (and companions), and Guava's `ImmutableList` (and companions).

In the case of `Map`, we can create an unmodifiable/immutable `Map` via `unmodifiableMap()` or the `Map.of()` methods.

But we can also create an immutable empty Map via `Collections.emptyMap()`:

```
Map<Integer, MutableMelon> emptyMap = Collections.emptyMap();
```



Similar to `emptyMap()`, we have `Collections.emptyList()`, and `Collections.emptySet()`. These methods are very handy as returns in methods that return a Map, List, or Set, and we want to avoid returning `null`.

Alternatively, we can create an unmodifiable/immutable Map with a single element via `Collections.singletonMap(K key, V value)`:

```
// unmodifiable
Map<Integer, MutableMelon> mapOfSingleMelon
    = Collections.singletonMap(1, new MutableMelon("Gac", 1200));

// immutable
Map<Integer, ImmutableMelon> mapOfSingleMelon
    = Collections.singletonMap(1, new ImmutableMelon("Gac", 1200));
```



Similar to `singletonMap()`, we have `singletonList()` and `singleton()`. The latter is for Set.

Moreover, starting with JDK 9, we can create an unmodifiable Map via a method named `ofEntries()`. This method takes `Map.Entry` as an argument, as in the following example:

```
// unmodifiable Map.Entry containing the given key and value
import static java.util.Map.entry;
...
Map<Integer, MutableMelon> mapOfMelon = Map.ofEntries(
    entry(1, new MutableMelon("Apollo", 3000)),
    entry(2, new MutableMelon("Jade Dew", 3500)),
    entry(3, new MutableMelon("Cantaloupe", 1500))
);
```

Alternatively, an immutable Map is another option:

```
Map<Integer, ImmutableMelon> mapOfMelon = Map.ofEntries(
    entry(1, new ImmutableMelon("Apollo", 3000)),
    entry(2, new ImmutableMelon("Jade Dew", 3500)),
    entry(3, new ImmutableMelon("Cantaloupe", 1500))
);
```

In addition, an unmodifiable/immutable `Map` can be obtained from a modifiable/mutable `Map` via JDK 10, the `Map.copyOf (Map<? extends K, ? extends V> map)` method:

```
Map<Integer, ImmutableMelon> mapOfMelon = new HashMap<>();
mapOfMelon.put (1, new ImmutableMelon("Apollo", 3000));
mapOfMelon.put (2, new ImmutableMelon("Jade Dew", 3500));
mapOfMelon.put (3, new ImmutableMelon("Cantaloupe", 1500));

Map<Integer, ImmutableMelon> immutableMapOfMelon
    = Map.copyOf (mapOfMelon);
```

By way of a bonus for this section, let's talk about an immutable array.

Question: Can I create an immutable array in Java?

Answer: No, you cannot. Or... there is one way to make an immutable array in Java:

```
static final String[] immutable = new String[0];
```

So, all useful arrays in Java are mutable. But we can create a helper class to create immutable arrays based on `Arrays.copyOf()`, which copies the elements and creates a new array (behind the scenes, this method relies on `System.arraycopy()`).

So, our helper class is as follows:

```
import java.util.Arrays;

public final class ImmutableArray<T> {

    private final T[] array;

    private ImmutableArray(T[] a) {
        array = Arrays.copyOf(a, a.length);
    }

    public static <T> ImmutableArray<T> from(T[] a) {
        return new ImmutableArray<>(a);
    }

    public T get(int index) {
        return array[index];
    }

    // equals(), hashCode() and toString() omitted for brevity
}
```

A usage example is as follows:

```
ImmutableArray<String> sample =  
    ImmutableArray.from(new String[] {  
        "a", "b", "c"  
    });
```

110. Mapping a default value

Before JDK 8, the solution to this problem relied on a helper method, which basically checks the presence of the given key in a `Map` and returns the corresponding value, or a default value. Such a method can be written in a utility class or by extending the `Map` interface. By returning a default value, we avoid returning `null` if the given key was not found in the `Map`. Moreover, this is a convenient approach for relying on a default setting or configuration.

Starting with JDK 8, the solution to this problem consists of a simple invocation of the `Map.getOrDefault()` method. This method gets two arguments representing the key to look up in the `Map` method and the default value. The default value acts as the backup value that should be returned when the given key is not found.

For example, let's assume the following `Map` that wraps several databases and their default `host:port`:

```
Map<String, String> map = new HashMap<>();  
map.put("postgresql", "127.0.0.1:5432");  
map.put("mysql", "192.168.0.50:3306");  
map.put("cassandra", "192.168.1.5:9042");
```

And, let's try to see whether this `Map` contains the default `host:port` for Derby DB as well:

```
map.get("derby"); // null
```

Since Derby DB is not present in the map, the result will be `null`. This is not what we want. Actually, when the searched database is not present on the map, we can use MongoDB on `69:89.31.226:27017`, which is always available. Now, we can easily shape this behavior as follows:

```
// 69:89.31.226:27017  
String hp1 = map.getOrDefault("derby", "69:89.31.226:27017");  
  
// 192.168.0.50:3306  
String hp2 = map.getOrDefault("mysql", "69:89.31.226:27017");
```



This method is convenient for building fluent expressions and avoiding disrupting the code for `null` checks. Note that returning the default value doesn't mean that this value will be added to the `Map`. `Map` remains unmodified.

111. Computing whether absent/present in a map

Sometimes, a `Map` doesn't contain the exact *out-of-the-box* entry that we need. Moreover, when an entry is absent, returning a default entry is not an option as well. Basically, there are cases when we need to compute our entry.

For such cases, JDK 8 comes with a bunch of methods: `compute()`, `computeIfAbsent()`, `computeIfPresent()`, and `merge()`. Choosing between these methods is a matter of knowing each of them very well.

Let's now take a look at the implementation of these methods using examples.

Example 1 (`computeIfPresent()`)

Let's suppose that we have the following `Map`:

```
Map<String, String> map = new HashMap<>();
map.put("postgresql", "127.0.0.1");
map.put("mysql", "192.168.0.50");
```

We use this map to build JDBC URLs for different database types.

Let's assume that we want to build the JDBC URL for MySQL. If the `mysql` key is present in the map, then the JDBC URL should be computed based on the corresponding value, `jdbc:mysql://192.168.0.50/customers_db`. But if the `mysql` key is not present, then the JDBC URL should be `null`. In addition to this, if the result of our computation is `null` (the JDBC URL cannot be computed), then we want to remove this entry from the map.

This is a job for `V computeIfPresent(K key, BiFunction<? super K, ? super V, ? extends V> remappingFunction)`.

In our case, `BiFunction` used for computing the new value will be as follows (`k` is the key from the map, `v` is the value associated with the key):

```
BiFunction<String, String, String> jdbcUrl
    = (k, v) -> "jdbc:" + k + "://" + v + "/customers_db";
```

Once we have this function in place, we can compute the new value for the `mysql` key as follows:

```
// jdbc:mysql://192.168.0.50/customers_db
String mySqlJdbcUrl = map.computeIfPresent("mysql", jdbcUrl);
```

Since the `mysql` key is present in the map, the result will be `jdbc:mysql://192.168.0.50/customers_db`, and the new map contains the following entries:

```
postgres=127.0.0.1, mysql=jdbc:mysql://192.168.0.50/customers_db
```



Calling `computeIfPresent()` again will recompute the value, which means that it will result in something like `mysql= jdbc:mysql://jdbc:mysql://...`. Obviously, this is not OK, so pay attention to this aspect.

On the other hand, if we try the same computation for an entry that doesn't exist (for example, `volt`), then the returned value will be `null` and the map remains untouched:

```
// null
String voltdbJdbcUrl = map.computeIfPresent("volt", jdbcUrl);
```

Example 2 (computeIfAbsent())

Let's suppose that we have the following Map:

```
Map<String, String> map = new HashMap<>();
map.put("postgres", "jdbc:postgres://127.0.0.1/customers_db");
map.put("mysql", "jdbc:mysql://192.168.0.50/customers_db");
```

We use this map to build JDBC URLs for different databases.

Let's assume that we want to build the JDBC URL for MongoDB. This time, if the `mongodb` key is present in the map, then the corresponding value should be returned without further computations. But if this key is absent (or is associated with a `null` value), then it should be computed based on this key and the current IP and be added to the map. If the computed value is `null`, then `null` is the returned result and the map remains untouched.

Well, this is a job for `V computeIfAbsent (K key, Function<? super K, ? extends V> mappingFunction)`.

In our case, `Function` used to compute the value will be as follows (the first `String` is the key from the map (`k`), while the second `String` is the value computed for this key):

```
String address = InetAddress.getLocalHost().getHostAddress();

Function<String, String> jdbcUrl
    = k -> k + "://" + address + "/customers_db";
```

Based on this function, we can try to obtain the JDBC URL for MongoDB via the `mongodb` key as follows:

```
// mongodb://192.168.100.10/customers_db
String mongodbJdbcUrl = map.computeIfAbsent("mongodb", jdbcUrl);
```

Since our map doesn't contain the `mongodb` key, it will be computed and added to the map.

If our `Function` is evaluated to `null`, then the map remains untouched and the returned value is `null`.



Calling `computeIfAbsent ()` again will not recompute the value. This time, since `mongodb` is in the map (it was added at the previous call), the returned value will be `mongodb://192.168.100.10/customers_db`. This is the same as trying to fetch the JDBC URL for `mysql`, which will return `jdbc:mysql://192.168.0.50/customers_db` without further computations.

Example 3 (compute())

Let's suppose that we have the following Map:

```
Map<String, String> map = new HashMap<>();
map.put("postgresql", "127.0.0.1");
map.put("mysql", "192.168.0.50");
```

We use this map to build JDBC URLs for different database types.

Let's assume that we want to build the JDBC URLs for MySQL and Derby DB. In this case, irrespective of whether the key (`mysql` or `derby`) is present in the map, the JDBC URL should be computed based on the corresponding key and value (which can be `null`). In addition, if the key is present in the map and the result of our computation is `null` (the JDBC URL cannot be computed), then we want to remove this entry from the map. Basically, this is a combination of `computeIfPresent()` and `computeIfAbsent()`.

This is a job for `V compute(K key, BiFunction<? super K, ? super V, ? extends V> remappingFunction)`.

This time, `BiFunction` should be written to cover the case when the value of the searched key is `null`:

```
String address = InetAddress.getLocalHost().getHostAddress();
BiFunction<String, String, String> jdbcUrl = (k, v)
    -> "jdbc:" + k + "://" + ((v == null) ? address : v)
    + "/customers_db";
```

Now, let's compute the JDBC URL for MySQL. Since the `mysql` key is present in the map, the computation will rely on the corresponding value, `192.168.0.50`. The result will update the value of the `mysql` key in the map:

```
// jdbc:mysql://192.168.0.50/customers_db
String mysqlJdbcUrl = map.compute("mysql", jdbcUrl);
```

In addition, let's compute the JDBC URL for Derby DB. Since the `derby` key is not present in the map, the computation will rely on the current IP. The result will be added to the map under the `derby` key:

```
// jdbc:derby://192.168.100.10/customers_db
String derbyJdbcUrl = map.compute("derby", jdbcUrl);
```

After these two computations, the map will contain the following three entries:

- postgresql=127.0.0.1
- derby=jdbc:derby://192.168.100.10/customers_db
- mysql=jdbc:mysql://192.168.0.50/customers_db



Pay attention to the fact that calling `compute()` again will recompute the values. This can lead to unwanted results such as `jdbc:derby://jdbc:derby://...`

If the result of the computation is `null` (for example, the JDBC URL cannot be computed) and the key (for example, `mysql`) exists in the map, then this entry will be removed from the map and the returned result is `null`.

Example 4 (merge())

Let's suppose that we have the following Map:

```
Map<String, String> map = new HashMap<>();
map.put("postgresql", "9.6.1 ");
map.put("mysql", "5.1 5.2 5.6 ");
```

We use this map to store the versions of each database type separated by a space.

Now, let's assume that every time a new version of a database type is released, we want to add it to our map under the corresponding key. If the key (for example, `mysql`) is present in the map, then we want to simply concatenate the new version to the end of the current value. If the key (for example, `derby`) is not present in the map, then we just want to add it now.

This is the perfect job for `V.merge(K key, V value, BiFunction<? super V, ? super V, ? extends V> remappingFunction)`.

If the given key (`K`) is not associated with a value or is associated with `null`, then the new value will be `V`. If the given key (`K`) is associated with a non-`null` value, then the new value is computed based on the given `BiFunction`. If the result of this `BiFunction` is `null`, and the key is present in the map, then this entry will be removed from the map.

In our case, we want to concatenate the current value with the new version, so our `BiFunction` can be written as follows:

```
BiFunction<String, String, String> jdbcUrl = String::concat;
```

We have a similar situation with the following:

```
BiFunction<String, String, String> jdbcUrl  
    = (vold, vnew) -> vold.concat(vnew);
```

For example, let's suppose that we want to concatenate in the map version 8.0 of MySQL. This can be accomplished as follows:

```
// 5.1 5.2 5.6 8.0  
String mySqlVersion = map.merge("mysql", "8.0 ", jdbcUrl);
```

Later on, we concatenate version 9.0 as well:

```
// 5.1 5.2 5.6 8.0 9.0  
String mySqlVersion = map.merge("mysql", "9.0 ", jdbcUrl);
```

Or, we add version 10.11.1.1 of Derby DB. This will result in a new entry in the map since there is no `derby` key present:

```
// 10.11.1.1  
String derbyVersion = map.merge("derby", "10.11.1.1 ", jdbcUrl);
```

At the end of these three operations, the map entries will be as follows:

```
postgresql=9.6.1, derby=10.11.1.1, mysql=5.1 5.2 5.6 8.0 9.0
```

Example 5 (putIfAbsent())

Let's suppose that we have the following `Map`:

```
Map<Integer, String> map = new HashMap<>();  
map.put(1, "postgresql");  
map.put(2, "mysql");  
map.put(3, null);
```

We use this map to store the names of some database types.

Now, let's suppose that we want to include more database types in this map based on the following constraints:

- If the given key is present in the map, then simply return the corresponding value and leave the map untouched.
- If the given key is not present in the map (or is associated with a `null` value), then put the given value in the map and return `null`.

Well, this is a job for `putIfAbsent(K key, V value)`.

The following three attempts speak for themselves:

```
String v1 = map.putIfAbsent(1, "derby"); // postgresql
String v2 = map.putIfAbsent(3, "derby"); // null
String v3 = map.putIfAbsent(4, "cassandra"); // null
```

And the map content is as follows:

```
1=postgresql, 2=mysql, 3=derby, 4=cassandra
```

112. Removal from a Map

Removal from a `Map` can be accomplished by a key, or by a key and value.

For example, let's assume that we have the following `Map`:

```
Map<Integer, String> map = new HashMap<>();
map.put(1, "postgresql");
map.put(2, "mysql");
map.put(3, "derby");
```

Removal by key is as simple as calling the `V Map.remove(Object key)` method. If the entry corresponding to the given key is successfully removed, then this method returns the associated value, otherwise it returns `null`.

Check the following examples:

```
String r1 = map.remove(1); // postgresql
String r2 = map.remove(4); // null
```

Now, the map contains the following entries (the entry from key 1 was removed):

```
2=mysql, 3=derby
```

Starting with JDK 8, the `Map` interface was enriched with a new `remove()` flag method with the following signature: `boolean remove(Object key, Object value)`. Using this method, we can remove an entry from a map only if there is a perfect match between the given key and value. Basically, this method is a shortcut of the following compound condition: `map.containsKey(key) && Objects.equals(map.get(key), value)`.

Let's have two simple examples:

```
// true
boolean r1 = map.remove(2, "mysql");

// false (the key is present, but the values don't match)
boolean r2 = map.remove(3, "mysql");
```

The resultant map contains the single remaining entry, `3=derby`.

Iterating and removing from a `Map` can be accomplished in at least two ways; first, via an `Iterator` (solution present in the bundled code), and second, starting with JDK 8, we can do it via `removeIf(Predicate<? super E> filter)`:

```
map.entrySet().removeIf(e -> e.getValue().equals("mysql"));
```

More details about removing from a collection are available in the *Removing all elements of a collection that match a predicate* section.

113. Replacing entries from a Map

Replacing entries from a `Map` is a problem that can be encountered in a wide range of cases. The convenient solution to accomplish this and avoid a snippet of *spaghetti* code written in a helper method relies on JDK 8, the `replace()` method.

Let's assume that we have the following `Melon` class and a map of `Melon`:

```
public class Melon {

    private final String type;
    private final int weight;

    // constructor, getters, equals(), hashCode(),
    // toString() omitted for brevity
}

Map<Integer, Melon> mapOfMelon = new HashMap<>();
```

```
mapOfMelon.put (1, new Melon("Apollo", 3000));
mapOfMelon.put (2, new Melon("Jade Dew", 3500));
mapOfMelon.put (3, new Melon("Cantaloupe", 1500));
```

Replacing the melon corresponding to key 2 can be accomplished by means of `replace(K key, V value)`. If the replacement is successful, then this method will return the initial `Melon`:

```
// Jade Dew(3500g) was replaced
Melon melon = mapOfMelon.replace (2, new Melon("Gac", 1000));
```

Now, the map contains the following entries:

```
1=Apollo(3000g), 2=Gac(1000g), 3=Cantaloupe(1500g)
```

Furthermore, let's suppose that we want to replace the entry with key 1 and the Apollo melon (3,000g). So, the melon should be the same one in order to obtain a successful replacement. This can be accomplished via the Boolean, `replace(K key, V oldValue, V newValue)`. This method relies on the `equals()` contract to compare the given values; therefore `Melon` needs to implement the `equals()` method, otherwise the result will be unpredictable:

```
// true
boolean melon = mapOfMelon.replace (
    1, new Melon("Apollo", 3000), new Melon("Bitter", 4300));
```

Now, the map contains the following entries:

```
1=Bitter(4300g), 2=Gac(1000g), 3=Cantaloupe(1500g)
```

Finally, let's assume that we want to replace all entries from a `Map` based on a given function. This can be done via `void replaceAll(BiFunction<? super K, ? super V, ? extends V> function)`.

For example, let's replace all melons that weigh more than 1,000 g with melons weighing equal to 1,000g. The following `BiFunction` shapes this function (`k` is the key and `v` is the value of each entry from the `Map`):

```
BiFunction<Integer, Melon, Melon> function = (k, v)
    -> v.getWeight() > 1000 ? new Melon(v.getType(), 1000) : v;
```

Next, `replaceAll()` appears on the scene:

```
mapOfMelon.replaceAll (function);
```

Now, the map contains the following entries:

```
1=Bitter(1000g), 2=Gac(1000g), 3=Cantaloupe(1000g)
```

114. Comparing two maps

Comparing two maps is straightforward as long as we rely on the `Map.equals()` method. When comparing two maps, this method compares the keys and values of them using the `Object.equals()` method.

For example, let's consider two maps of melons having the same entries (the presence of `equals()` and `hashCode()` is a must in the `Melon` class):

```
public class Melon {

    private final String type;
    private final int weight;

    // constructor, getters, equals(), hashCode(),
    // toString() omitted for brevity
}

Map<Integer, Melon> melons1Map = new HashMap<>();
Map<Integer, Melon> melons2Map = new HashMap<>();
melons1Map.put(1, new Melon("Apollo", 3000));
melons1Map.put(2, new Melon("Jade Dew", 3500));
melons1Map.put(3, new Melon("Cantaloupe", 1500));
melons2Map.put(1, new Melon("Apollo", 3000));
melons2Map.put(2, new Melon("Jade Dew", 3500));
melons2Map.put(3, new Melon("Cantaloupe", 1500));
```

Now, if we test `melons1Map` and `melons2Map` for equality, then we obtain `true`:

```
boolean equals12Map = melons1Map.equals(melons2Map); // true
```

But this will not work if we use arrays. For example, consider the next two maps:

```
Melon[] melons1Array = {
    new Melon("Apollo", 3000),
    new Melon("Jade Dew", 3500), new Melon("Cantaloupe", 1500)
};
Melon[] melons2Array = {
    new Melon("Apollo", 3000),
    new Melon("Jade Dew", 3500), new Melon("Cantaloupe", 1500)
};
```

```
Map<Integer, Melon[]> melons1ArrayMap = new HashMap<>();
melons1ArrayMap.put(1, melons1Array);
Map<Integer, Melon[]> melons2ArrayMap = new HashMap<>();
melons2ArrayMap.put(1, melons2Array);
```

Even if `melons1ArrayMap` and `melons2ArrayMap` are equal, `Map.equals()` will return `false`:

```
boolean equals12ArrayMap = melons1ArrayMap.equals(melons2ArrayMap);
```

The problem originates in the fact that the array's `equals()` method compares identity and not the contents of the array. In order to solve this problem, we can write a helper method as follows (this time relying on `Arrays.equals()`, which compares the contents of the arrays):

```
public static <A, B> boolean equalsWithArrays(
    Map<A, B[]> first, Map<A, B[]> second) {

    if (first.size() != second.size()) {
        return false;
    }

    return first.entrySet().stream()
        .allMatch(e -> Arrays.equals(e.getValue(),
            second.get(e.getKey())));
}
```

115. Sorting a Map

There are several solutions for sorting a `Map`. For a start, let's assume the following `Map of Melon`:

```
public class Melon implements Comparable {

    private final String type;
    private final int weight;

    @Override
    public int compareTo(Object o) {
        return Integer.compare(this.getWeight(), ((Melon) o).getWeight());
    }

    // constructor, getters, equals(), hashCode(),
    // toString() omitted for brevity
}
```

```
Map<String, Melon> melons = new HashMap<>();
melons.put("delicious", new Melon("Apollo", 3000));
melons.put("refreshing", new Melon("Jade Dew", 3500));
melons.put("famous", new Melon("Cantaloupe", 1500));
```

Now, let's examine several solutions for sorting this `Map`. Basically, the goal is to expose the methods from the following screenshot via a utility class named `Maps`:

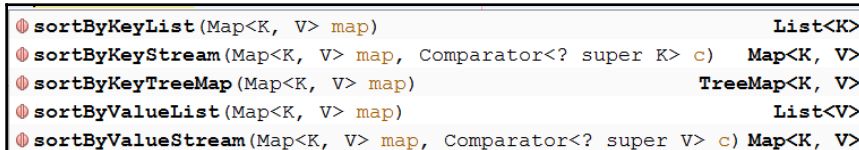

```

① sortByKeyList (Map<K, V> map) List<K>
① sortByKeyStream (Map<K, V> map, Comparator<? super K> c) Map<K, V>
① sortByKeyTreeMap (Map<K, V> map) TreeMap<K, V>
① sortByValueList (Map<K, V> map) List<V>
① sortByValueStream (Map<K, V> map, Comparator<? super V> c) Map<K, V>

```

Let's take a look at the different solutions in the next sections.

Sorting by key via `TreeMap` and natural ordering

A quick solution to sorting a `Map` relies on `TreeMap`. By definition, the keys in `TreeMap` are sorted by their natural order. Moreover, `TreeMap` has a constructor of the `TreeMap (Map<? extends K,? extends V> m)` type:

```
public static <K, V> TreeMap<K, V> sortByKeyTreeMap (Map<K, V> map) {
    return new TreeMap<> (map);
}
```

And calling it will sort the map by key:

```
// {delicious=Apollo(3000g),
// famous=Cantaloupe(1500g), refreshing=Jade Dew(3500g)}
TreeMap<String, Melon> sortedMap = Maps.sortByKeyTreeMap(melons);
```

Sorting by key and value via `Stream` and `Comparator`

Once we create a `Stream` for a map, we can easily sort it by means of the `Stream.sorted()` method with or without a `Comparator`. This time, let's use a `Comparator`:

```
public static <K, V> Map<K, V> sortByKeyStream(
    Map<K, V> map, Comparator<? super K> c) {
```

```

return map.entrySet()
    .stream()
    .sorted(Map.Entry.comparingByKey(c))
    .collect(toMap(Map.Entry::getKey, Map.Entry::getValue,
        (v1, v2) -> v1, LinkedHashMap::new));
}

public static <K, V> Map<K, V> sortByValueStream(
    Map<K, V> map, Comparator<? super V> c) {

    return map.entrySet()
        .stream()
        .sorted(Map.Entry.comparingByValue(c))
        .collect(toMap(Map.Entry::getKey, Map.Entry::getValue,
            (v1, v2) -> v1, LinkedHashMap::new));
}

```

We need to rely on `LinkedHashMap` instead of `HashMap`. Otherwise, we cannot preserve the iteration order.

Let's sort our map as follows:

```

// {delicious=Apollo(3000g),
//  famous=Cantaloupe(1500g),
//  refreshing=Jade Dew(3500g)}
Comparator<String> byInt = Comparator.naturalOrder();
Map<String, Melon> sortedMap = Maps.sortByKeyStream(melons, byInt);

// {famous=Cantaloupe(1500g),
//  delicious=Apollo(3000g),
//  refreshing=Jade Dew(3500g)}
Comparator<Melon> byWeight = Comparator.comparing(Melon::getWeight);
Map<String, Melon> sortedMap
    = Maps.sortByValueStream(melons, byWeight);

```

Sorting by key and value via List

The preceding examples sort the given map, and the result is also a map. If all we need is the sorted keys (and we don't care about the values) or vice versa, then we can rely on a `List` created via `Map.keySet()` for keys, and via `Map.values()` for values:

```

public static <K extends Comparable, V> List<K>
    sortByKeyList(Map<K, V> map) {

    List<K> list = new ArrayList<>(map.keySet());
}

```

```
        Collections.sort(list);

        return list;
    }

    public static <K, V extends Comparable> List<V>
        sortByValueList(Map<K, V> map) {

        List<V> list = new ArrayList<>(map.values());
        Collections.sort(list);

        return list;
    }
}
```

Now, let's sort our map:

```
// [delicious, famous, refreshing]
List<String> sortedKeys = Maps.sortByKeyList(melons);

// [Cantaloupe(1500g), Apollo(3000g), Jade Dew(3500g)]
List<Melon> sortedValues = Maps.sortByValueList(melons);
```

If duplicate values are not allowed, then you have to rely on an implementation using `SortedSet`:

```
SortedSet<String> sortedKeys = new TreeSet<>(melons.keySet());
SortedSet<Melon> sortedValues = new TreeSet<>(melons.values());
```

116. Copying HashMap

A handy solution for performing a shallow copy of `HashMap` relies on the `HashMap` constructor, `HashMap(Map<? extends K, ? extends V> m)`. The following code is self-explanatory:

```
Map<K, V> mapToCopy = new HashMap<>();
Map<K, V> shallowCopy = new HashMap<>(mapToCopy);
```

Another solution may rely on the `putAll(Map<? extends K, ? extends V> m)` method. This method copies all of the mappings from the specified map to this map, as shown in the following helper method:

```
@SuppressWarnings("unchecked")
public static <K, V> HashMap<K, V> shallowCopy(Map<K, V> map) {

    HashMap<K, V> copy = new HashMap<>();
    copy.putAll(map);
}
```

```
    return copy;
}
```

We can also write a helper method in Java 8 functional style as follows:

```
@SuppressWarnings("unchecked")
public static <K, V> HashMap<K, V> shallowCopy(Map<K, V> map) {

    Set<Entry<K, V>> entries = map.entrySet();
    HashMap<K, V> copy = (HashMap<K, V>) entries.stream()
        .collect(Collectors.toMap(
            Map.Entry::getKey, Map.Entry::getValue));

    return copy;
}
```

However, these three solutions only provide a shallow copy of the map. A solution for obtaining a deep copy can rely on the Cloning library (<https://github.com/kostaskougios/cloning>) introduced in Chapter 2, *Objects, Immutability, and Switch Expressions*. A helper method that will use Cloning can be written as follows:

```
@SuppressWarnings("unchecked")
public static <K, V> HashMap<K, V> deepCopy(Map<K, V> map) {
    Cloner cloner = new Cloner();
    HashMap<K, V> copy = (HashMap<K, V>) cloner.deepClone(map);

    return copy;
}
```

117. Merging two maps

Merging two maps is the process of joining two maps into a single map that contains the elements of both maps. Furthermore, for key collisions, we incorporate in the final map the value belonging to the second map. But this is a design decision.

Let's consider the following two maps (we intentionally added a collision for key 3):

```
public class Melon {

    private final String type;
    private final int weight;

    // constructor, getters, equals(), hashCode(),
    // toString() omitted for brevity
}
```



```
Map<Integer, Melon> melons1 = new HashMap<>();
Map<Integer, Melon> melons2 = new HashMap<>();
melons1.put(1, new Melon("Apollo", 3000));
melons1.put(2, new Melon("Jade Dew", 3500));
melons1.put(3, new Melon("Cantaloupe", 1500));
melons2.put(3, new Melon("Apollo", 3000));
melons2.put(4, new Melon("Jade Dew", 3500));
melons2.put(5, new Melon("Cantaloupe", 1500));
```

Starting with JDK 8, we have the following method in `Map`: `V merge(K key, V value, BiFunction<? super V, ? super V, ? extends V> remappingFunction)`.

If the given key (`K`) is not associated with a value, or is associated with `null`, then the new value will be `V`. If the given key (`K`) is associated with a non-`null` value, then the new value is computed based on the given `BiFunction`. If the result of this `BiFunction` is `null`, and the key is present in the map, then this entry will be removed from the map.

Based on this definition, we can write a helper method for merging two maps as follows:

```
public static <K, V> Map<K, V> mergeMaps(
    Map<K, V> map1, Map<K, V> map2) {

    Map<K, V> map = new HashMap<>(map1);

    map2.forEach(
        (key, value) -> map.merge(key, value, (v1, v2) -> v2));

    return map;
}
```

Note that we don't modify the original maps. We prefer to return a new map containing the elements of the first map merged with the elements of the second map. In the case of a collision of keys, we replace the existing value with the value from the second map (`v2`).

Another solution can be written based on `Stream.concat()`. Basically, this method concatenates two streams into a single `Stream`. In order to create a `Stream` from a `Map`, we call `Map.entrySet().stream()`. After concatenating the two streams created from the given maps, we simply collect the result via the `toMap()` collector:

```
public static <K, V> Map<K, V> mergeMaps(
    Map<K, V> map1, Map<K, V> map2) {
```

```
Stream<Map.Entry<K, V>> combined
    = Stream.concat(map1.entrySet().stream(),
        map2.entrySet().stream());

Map<K, V> map = combined.collect(
    Collectors.toMap(Map.Entry::getKey, Map.Entry::getValue,
        (v1, v2) -> v2));

return map;
}
```

As a bonus, a Set (for example, a Set of integers) can be sorted as follows:

```
List<Integer> sortedList = someSetOfIntegers.stream()
    .sorted().collect(Collectors.toList());
```

For objects, rely on `sorted(Comparator<? super T>)`.

118. Removing all elements of a collection that match a predicate

Our collection will hold a bunch of `Melon`:

```
public class Melon {

    private final String type;
    private final int weight;

    // constructor, getters, equals(),
    // hashCode(), toString() omitted for brevity
}
```

Let's assume the following collection (`ArrayList`) throughout our examples to demonstrate how we can remove elements from it that match a given predicate:

```
List<Melon> melons = new ArrayList<>();
melons.add(new Melon("Apollo", 3000));
melons.add(new Melon("Jade Dew", 3500));
melons.add(new Melon("Cantaloupe", 1500));
melons.add(new Melon("Gac", 1600));
melons.add(new Melon("Hami", 1400));
```

Let's take a look at the different solutions given in the following sections.

Removing via an iterator

Removing via an `Iterator` is the oldest approach available in Java. Mainly, an `Iterator` allows us to iterate (or traverse) a collection and remove certain elements. The oldest approach also has some drawbacks. First of all, depending on the collection type, removing via an `Iterator` is prone to `ConcurrentModificationException` if multiple threads modify the collection. Moreover, removal does not behave the same for all collections (for example, removing from a `LinkedList` is faster than removing from an `ArrayList` because the former simply moves the pointer to the next element while the latter needs to shift elements). Nevertheless, the solution is available in the bundled code.

If all you need is the size of `Iterable`, then consider one of the following approaches:

```
// for any Iterable
StreamSupport.stream(iterable.spliterator(), false).count();

// for collections
((Collection<?>) iterable).size()
```

Removing via `Collection.removeIf()`

Starting with JDK 8, we can reduce the preceding code to a single line of code via the `Collection.removeIf()` method. This method relies on `Predicate`, as in the following example:

```
melons.removeIf(t -> t.getWeight() < 3000);
```

This time, the `ArrayList` iterates the list and marks for deletion those elements that satisfy our `Predicate`. Furthermore, `ArrayList` iterates again to remove the marked elements and shift the remaining elements.

Using this approach, `LinkedList` and `ArrayList` perform in almost an identical fashion.

Removing via Stream

Starting with JDK 8, we can create a `Stream` from a collection (`Collection.stream()`) and filter its elements via `filter(Predicate p)`. The filter will only retain those elements that satisfy the given `Predicate`.

Finally, we collect these elements via the proper collector:

```
List<Melon> filteredMelons = melons.stream()
    .filter(t -> t.getWeight() >= 3000)
    .collect(Collectors.toList());
```



Unlike the other two solutions, this one doesn't mutate the original collection, but it may be slower and consume more memory.

Separating elements via `Collectors.partitioningBy()`

Sometimes, we don't want to delete the elements that don't match our predicate. What we actually want is to separate elements based on our predicate. Well, this is achievable via `Collectors.partitioningBy(Predicate p)`.

Basically, `Collectors.partitioningBy()` will separate the elements into two lists. These two lists are added to a `Map` as values. The two keys of this `Map` will be `true` and `false`:

```
Map<Boolean, List<Melon>> separatedMelons = melons.stream()
    .collect(Collectors.partitioningBy(
        (Melon t) -> t.getWeight() >= 3000));

List<Melon> weightLessThan3000 = separatedMelons.get(false);
List<Melon> weightGreaterThan3000 = separatedMelons.get(true);
```

So, the `true` key is for retrieving the `List` that contains the elements that match the predicate, while the `false` key is for retrieving the `List` that contains the elements that didn't match the predicate.

By way of a bonus, if we want to check whether all the elements of a `List` are the same, then we can rely on `Collections.frequency(Collection c, Object obj)`. This method returns the number of elements in the specified collection equal to the specified object:

```
boolean allTheSame = Collections.frequency(
    melons, melons.get(0)) == melons.size();
```

If `allTheSame` is `true`, then all elements are the same. Note that `equals()` and `hashCode()` of the object from the `List` must be implemented accordingly.

119. Converting a collection into an array

In order to convert a collection into an array, we can rely on the `Collection.toArray()` method. Without arguments, this method will convert the given collection into an `Object[]`, as in the following example:

```
List<String> names = Arrays.asList("ana", "mario", "vio");
Object[] namesArrayAsObjects = names.toArray();
```

Obviously, this is not entirely useful since we are expecting a `String[]` instead of `Object[]`. This can be accomplished via `Collection.toArray(T[] a)` as follows:

```
String[] namesArraysAsStrings = names.toArray(new
String[names.size()]);
String[] namesArraysAsStrings = names.toArray(new String[0]);
```

From these two solutions, the second one is preferable since we avoid computing the collection size.

But starting with JDK 11, there is one more method dedicated to this task, `Collection.toArray(IntFunction<T[]> generator)`. This method returns an array containing all the elements in this collection, using the generator function provided to allocate the returned array:

```
String[] namesArraysAsStrings = names.toArray(String[]::new);
```

Next to the fixed-size modifiable `Arrays.asList()`, we can build an unmodifiable `List/Set` from an array via the `of()` methods:

```
String[] namesArray = {"ana", "mario", "vio"};

List<String> namesArrayAsList = List.of(namesArray);
Set<String> namesArrayAsSet = Set.of(namesArray);
```

120. Filtering a Collection by a List

A common problem that we encounter in applications is filtering a `Collection` by a `List`. Mainly, we start from a huge `Collection`, and we want to extract from it the elements that match the elements of a `List`.

In the following examples, let's consider the `Melon` class:

```
public class Melon {  
  
    private final String type;  
    private final int weight;  
  
    // constructor, getters, equals(), hashCode(),  
    // toString() omitted for brevity  
}
```

Here, we have a huge `Collection` (in this case, an `ArrayList`) of `Melon`:

```
List<Melon> melons = new ArrayList<>();  
melons.add(new Melon("Apollo", 3000));  
melons.add(new Melon("Jade Dew", 3500));  
melons.add(new Melon("Cantaloupe", 1500));  
melons.add(new Melon("Gac", 1600));  
melons.add(new Melon("Hami", 1400));  
...
```

And we also have a `List` containing the types of melons that we want to extract from the preceding `ArrayList`:

```
List<String> melonsByType  
    = Arrays.asList("Apollo", "Gac", "Crenshaw", "Hami");
```

One solution to this problem may involve looping both collections and comparing the types of melons, but the resultant code will be pretty slow. Another solution to this problem may involve the `List.contains()` method and a lambda expression:

```
List<Melon> results = melons.stream()  
    .filter(t -> melonsByType.contains(t.getType()))  
    .collect(Collectors.toList());
```

The code is compact and fast. Behind the scenes, `List.contains()` relies on the following check:

```
// size - the size of melonsByType  
// o - the current element to search from melons  
// elementData - melonsByType  
for (int i = 0; i < size; i++)  
    if (o.equals(elementData[i])) {  
        return i;  
    }  
}
```

However, we can give another boost to performance via a solution that relies on `HashSet.contains()` instead of `List.contains()`. While `List.contains()` uses the preceding for statement to match the elements, `HashSet.contains()` uses `Map.containsKey()`. Mainly, `Set` is implemented based on a `Map`, and each added element is mapped as a key-value of the `element-PRESENT` type. So, `element` is a key in this `Map`, while `PRESENT` is just a dummy value.

When we call `HashSet.contains(element)`, we actually call `Map.containsKey(element)`. This method matches the given element with the proper key in the map based on its `hashCode()`, which is much faster than `equals()`.

Once we convert the initial `ArrayList` to a `HashSet`, we are ready to go:

```
Set<String> melonsSetByType = melonsByType.stream()
    .collect(Collectors.toSet());

List<Melon> results = melons.stream()
    .filter(t -> melonsSetByType.contains(t.getType()))
    .collect(Collectors.toList());
```

Well, this solution is faster than the previous one. It should run in half of the time required by the previous solution.

121. Replacing elements of a List

Another common problem that we encounter in applications entails replacing the elements of a `List` that matches certain conditions.

In the following example, let's consider the `Melon` class:

```
public class Melon {

    private final String type;
    private final int weight;

    // constructor, getters, equals(), hashCode(),
    // toString() omitted for brevity
}
```

And then, let's consider a List of Melon:

```
List<Melon> melons = new ArrayList<>();

melons.add(new Melon("Apollo", 3000));
melons.add(new Melon("Jade Dew", 3500));
melons.add(new Melon("Cantaloupe", 1500));
melons.add(new Melon("Gac", 1600));
melons.add(new Melon("Hami", 1400));
```

Let's assume that we want to replace all melons weighing less than 3,000 grams with other melons of the same types and that weigh 3,000 grams.

A solution to this problem will entail iterating the List and then using List.set(int index, E element) to replace the melons accordingly.

This is a snippet of spaghetti code as follows:

```
for (int i = 0; i < melons.size(); i++) {
    if (melons.get(i).getWeight() < 3000) {
        melons.set(i, new Melon(melons.get(i).getType(), 3000));
    }
}
```

Another solution relies on Java 8 functional style or, more precisely, on the UnaryOperator functional interface.

Based on this functional interface, we can write the following operator:

```
UnaryOperator<Melon> operator = t
    -> (t.getWeight() < 3000) ? new Melon(t.getType(), 3000) : t;
```

Now, we can use the JDK 8, List.replaceAll(UnaryOperator<E> operator), as follows:

```
melons.replaceAll(operator);
```

Both approaches should perform almost the same.

122. Thread-safe collections, stacks, and queues

Whenever a collection/stack/queue is prone to be accessed by multiple threads, it is also prone to concurrency-specific exceptions (for example, `java.util.ConcurrentModificationException`). Now, let's have a brief overview of, and introduction to, the Java built-in concurrent collections.

Concurrent collections

Fortunately, Java provides thread-safe (concurrent) alternatives to non-thread-safe collections (including stacks and queues), as follows.

Thread-safe lists

The thread-safe version of an `ArrayList` is `CopyOnWriteArrayList`. The following table enumerates the Java built-in single-threaded and multithreaded lists:

Single thread	Multithreaded
<code>ArrayList</code>	<code>CopyOnWriteArrayList</code> (often reads, seldom updates)
<code>LinkedList</code>	<code>Vector</code>

The `CopyOnWriteArrayList` implementation holds the elements in an array. Every time we invoke a method that mutates the list (for example, `add()`, `set()`, and `remove()`), Java will operate on a copy of this array.

An `Iterator` over this collection will operate on an immutable copy of the collection. Therefore, the original collection can be modified without issues. Potential modifications of the original collection are not visible in the `Iterator`:

```
List<Integer> list = new CopyOnWriteArrayList<>();
```



Use this collection when reads are frequent and changes are seldom.

Thread-safe set

The thread-safe version of a `Set` is `CopyOnWriteArraySet`. The following table enumerates the Java built-in single-threaded and multithreaded sets:

Single thread	Multithreaded
HashSet	
TreeSet (sorted set)	ConcurrentSkipListSet (sorted set)
LinkedHashSet (maintain insertions order)	CopyOnWriteArraySet (often reads, seldom updates)
BitSet	
EnumSet	

This is a `Set` that uses an internal `CopyOnWriteArrayList` for all of its operations. Creating such a `Set` can be done as follows:

```
Set<Integer> set = new CopyOnWriteArraySet<>();
```



Use this collection when reads are frequent and changes are seldom.

The thread-safe version of `NavigableSet` is `ConcurrentSkipListSet` (concurrent `SortedSet` implementation, with most basic operations in $O(\log n)$).

Thread-safe map

The thread-safe version of a `Map` is `ConcurrentHashMap`.

The following table enumerates the Java built-in single-thread and multithreaded maps:

Single thread	Multithreaded
HashMap	
TreeMap (sorted keys)	ConcurrentHashMap
LinkedHashMap (maintain insertion order)	ConcurrentSkipListMap (sorted map)
IdentityHashMap (keys compared via <code>==</code>)	Hashtable
WeakHashMap	
EnumMap	

ConcurrentHashMap allows retrieval operations (for example, get ()) without blocking. This means that retrieval operations may overlap with update operations (including put () and remove ()).

Creating a ConcurrentHashMap can be done as follows:

```
ConcurrentMap<Integer, Integer> map = new ConcurrentHashMap<>();
```



Whenever thread safety and high performance are required, you can rely on the thread-safe version of a Map, which is ConcurrentHashMap.

Avoid Hashtable and Collections.synchronizedMap () since they have poor performance.

For a ConcurrentMap supporting NavigableMap, operations rely on ConcurrentSkipListMap:

```
ConcurrentNavigableMap<Integer, Integer> map
    = new ConcurrentSkipListMap<>();
```

Thread-safe queue backed by an array

Java provides a thread-safe queue (**First In First Out (FIFO)**) backed by an array via ArrayBlockingQueue. The following table lists the single-thread and multithreaded Java built-in queues backed by an array:

Single thread	Multithreaded
ArrayDeque	ArrayBlockingQueue (bounded)
PriorityQueue (sorted retrievals)	ConcurrentLinkedQueue (unbounded)
	ConcurrentLinkedDeque (unbounded)
	LinkedBlockingQueue (optionally bounded)
	LinkedBlockingDeque (optionally bounded)
	LinkedTransferQueue
	PriorityBlockingQueue
	SynchronousQueue
	DelayQueue
	Stack

The capacity of `ArrayBlockingQueue` cannot be changed following creation. Attempts to put an element into a full queue will result in the operation blocking; attempts to take an element from an empty queue will similarly block.

Creating `ArrayBlockingQueue` can easily be done as follows:

```
BlockingQueue<Integer> queue = new  
ArrayBlockingQueue<>(QUEUE_MAX_SIZE);
```



Java also comes with two thread-safe, optionally bounded blocking queues based on linked nodes via `LinkedBlockingQueue` and `LinkedBlockingDeque` (a deque is a linear collection that supports element insertion and removal at both ends).

Thread-safe queue based on linked nodes

Java provides an unbounded thread-safe queue/deque backed by linked nodes via `ConcurrentLinkedDeque`/`ConcurrentLinkedQueue`. Here, it is `ConcurrentLinkedDeque`:

```
Deque<Integer> queue = new ConcurrentLinkedDeque<>();
```

Thread-safe priority queue

Java provides an unbounded thread-safe priority blocking queue based on a priority heap via `PriorityBlockingQueue`.

Creating `PriorityBlockingQueue` can easily be done as follows:

```
BlockingQueue<Integer> queue = new PriorityBlockingQueue<>();
```



The non-thread-safe version is named `PriorityQueue`.

Thread-safe delay queue

Java provides a thread-safe unbounded blocking queue in which an element can only be taken when its delay has expired via `DelayQueue`. Creating a `DelayQueue` is as simple as the following:

```
BlockingQueue<TrainDelay> queue = new DelayQueue<>();
```

Thread-safe transfer queue

Java provides a thread-safe unbounded transfer queue based on linked nodes via `LinkedTransferQueue`.

This is a FIFO queue in which the *head* is the element that has been on the queue the longest time for some producer. The *tail* of the queue is the element that has been on the queue the shortest time for some producer.

One way to create this kind of queue is as follows:

```
TransferQueue<String> queue = new LinkedTransferQueue<>();
```

Thread-safe synchronous queue

Java provides a blocking queue in which each insert operation must wait for a corresponding remove operation by another thread, and vice versa, via `SynchronousQueue`:

```
BlockingQueue<String> queue = new SynchronousQueue<>();
```

Thread-safe stack

Thread-safe implementations of a stack are `Stack` and `ConcurrentLinkedDeque`.

The `Stack` class represents a **Last In First Out (LIFO)** stack of objects. It extends the `Vector` class with several operations that allow a vector to be treated as a stack. Every method of `Stack` is synchronized. Creating a `Stack` is as simple as the following:

```
Stack<Integer> stack = new Stack<>();
```

A `ConcurrentLinkedDeque` implementation can be used as a `Stack` (LIFO) via its `push()` and `pop()` methods:

```
Deque<Integer> stack = new ConcurrentLinkedDeque<>();
```



For better performance, prefer `ConcurrentLinkedDeque` over `Stack`.

The code bundled to this book comes with an application for each of the preceding collections meant to span several threads in order to reveal their thread-safe character.

Synchronized collections

Besides concurrent collections, we also have `synchronized` collections. Java provides a suite of wrappers that expose a collection as a thread-safe collection. These wrappers are available in `Collections`. The most common ones are as follows:

- `synchronizedCollection(Collection<T> c)`: Returns a synchronized (thread-safe) collection backed by the specified collection
- `synchronizedList(List<T> list)`: Returns a synchronized (thread-safe) list backed by the specified list:

```
List<Integer> syncList
    = Collections.synchronizedList(new ArrayList<>());
```

- `synchronizedMap(Map<K, V> m)`: Returns a synchronized (thread-safe) map backed by the specified map:

```
Map<Integer, Integer> syncMap
    = Collections.synchronizedMap(new HashMap<>());
```

- `synchronizedSet(Set<T> s)`: Returns a synchronized (thread-safe) set backed by the specified set:

```
Set<Integer> syncSet
    = Collections.synchronizedSet(new HashSet<>());
```

Concurrent versus synchronized collections

The obvious question is *What is the difference between a concurrent and a synchronized collection?* Well, the main difference consists of the way in which they achieve thread-safety. Concurrent collections achieve thread-safety by partitioning the data into segments. Threads can access these segments concurrently and obtain locks only on the segments that are used. On the other hand, synchronized collection locks the entire collection via *intrinsic locking* (a thread that invokes a synchronized method will automatically acquire the intrinsic lock for that method's object and release it when the method returns).

Iterating a synchronized collection requires manual synchronization as follows:

```
List syncList = Collections.synchronizedList(new ArrayList());
...
synchronized(syncList) {
    Iterator i = syncList.iterator();
    while (i.hasNext()) {
```

```

do_something_with i.next();
}
}

```



Since concurrent collections allow concurrent access of threads, they are much more performant than the synchronized collection.

123. Breadth-first search

BFS is a classic algorithm for traversing (visiting) all nodes of a graph or tree.

The easiest way to understand this algorithm is via pseudo-code and an example. The pseudo-code of BFS is as follows:

1. Create a queue *Q*
2. Mark *v* as visited and put *v* into *Q*
3. While *Q* is non-empty
4. Remove the head *h* of *Q*
5. Mark and en-queue all (unvisited) neighbors of *h*

Let's assume the graph from the following diagram, **Step 0**:

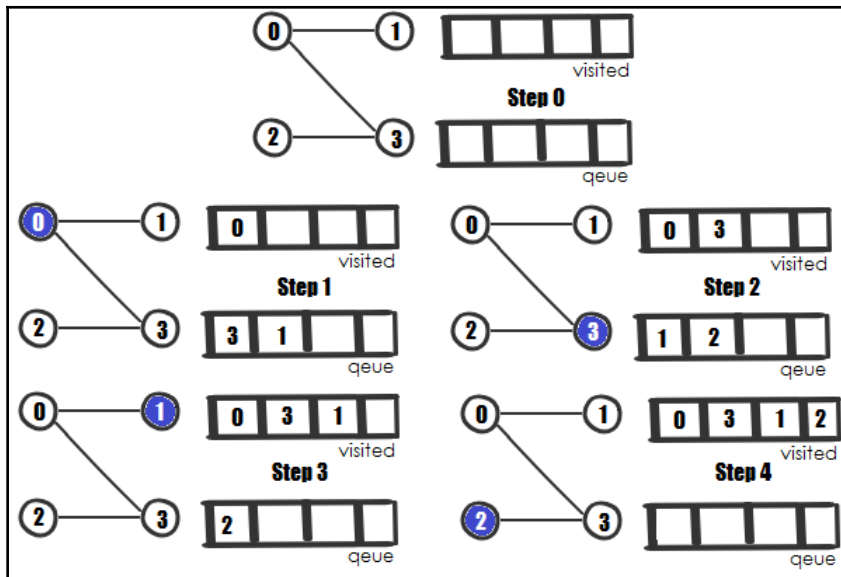

At the first step (**Step 1**), we visit vertex **0**. We put this in the `visited` list and all its adjacent vertices in the `queue` (**3**, **1**). Furthermore, at **Step 2**, we visit the element at the front of the `queue`, **3**. Vertex **3** has an unvisited adjacent vertex in **2**, so we add that to the back of the `queue`. Next, at **Step 3**, we visit the element at the front of the `queue`, **1**. This vertex has a single adjacent vertex (**0**), but this was visited. Finally, we visit vertex **2**, the last from the `queue`. This one has a single adjacent vertex (**3**) that was already visited.

In code lines, the BFS algorithm can be implemented as follows:

```
public class Graph {

    private final int v;
    private final LinkedList<Integer>[] adjacents;

    public Graph(int v) {

        this.v = v;
        adjacents = new LinkedList[v];

        for (int i = 0; i < v; ++i) {
            adjacents[i] = new LinkedList();
        }
    }

    public void addEdge(int v, int e) {
        adjacents[v].add(e);
    }

    public void BFS(int start) {

        boolean visited[] = new boolean[v];
        LinkedList<Integer> queue = new LinkedList<>();
        visited[start] = true;

        queue.add(start);

        while (!queue.isEmpty()) {
            start = queue.poll();
            System.out.print(start + " ");

            Iterator<Integer> i = adjacents[start].listIterator();
            while (i.hasNext()) {
                int n = i.next();
                if (!visited[n]) {
                    visited[n] = true;
                    queue.add(n);
                }
            }
        }
    }
}
```



```
    }  
  }  
}
```

And, if we introduce the following graph (from the preceding diagram), we have the following:

```
Graph graph = new Graph(4);  
graph.addEdge(0, 3);  
graph.addEdge(0, 1);  
graph.addEdge(1, 0);  
graph.addEdge(2, 3);  
graph.addEdge(3, 0);  
graph.addEdge(3, 2);  
graph.addEdge(3, 3);
```

The output will be 0 3 1 2.

124. Trie

A Trie (also known as digital tree) is an ordered tree structure used commonly for storing strings. Its name comes from the fact that Trie is *reTrieval* data structure. Its performance is better than a binary tree.

Except for the root of the Trie, every node of a Trie contains a single character (for example, for the word **hey**, there will be three nodes). Mainly, each node of a Trie contains the following:

- A value (a character, or a digit)
- Pointers to children nodes
- A flag that is `true` if the current node completes a word
- A single root used for branching nodes

The following diagram represents the sequence of steps for building a Trie containing the words **cat**, **caret**, and **bye**:

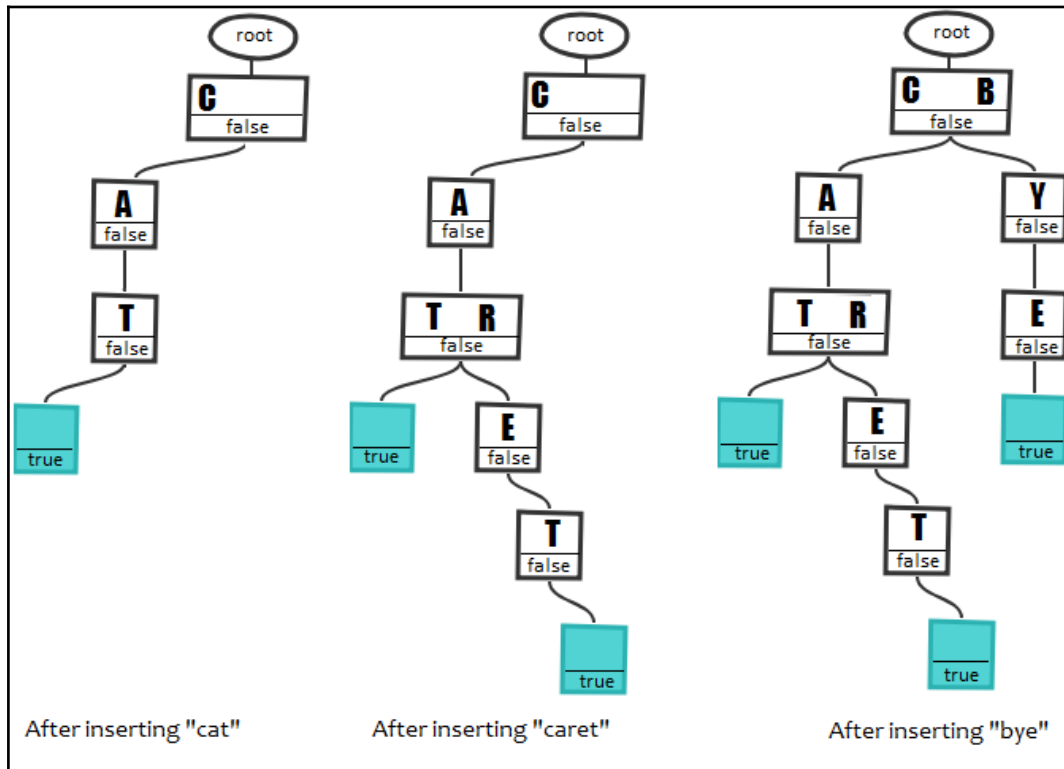

So, in code lines, a Trie node can be shaped as follows:

```
public class Node {

    private final Map<Character, Node> children = new HashMap<>();
    private boolean word;

    Map<Character, Node> getChildren() {
        return children;
    }

    public boolean isWord() {
        return word;
    }

    public void setWord(boolean word) {
        this.word = word;
    }
}
```

```
}  
}
```

Based on this class, we can define a Trie basic structure as follows:

```
class Trie {  
  
    private final Node root;  
  
    public Trie() {  
        root = new Node();  
    }  
  
    public void insert(String word) {  
        ...  
    }  
  
    public boolean contains(String word) {  
        ...  
    }  
  
    public boolean delete(String word) {  
        ...  
    }  
}
```

Inserting in a Trie

Now, let's focus on the algorithm for inserting words in a Trie:

1. Consider the current node as the root.
2. Loop the given word character by character, starting from the first character.
3. If the current node (the `Map<Character, Node>`) maps a value (a `Node`) for the current character, then simply advance to this node. Otherwise, create a new `Node`, set its character equal to the current character, and advance to this node.
4. Repeat from step 2 (pass to next character) until the end of the word.
5. Mark the current node as a node that completes the word.

In terms of code lines, we have the following:

```
public void insert(String word) {  
  
    Node node = root;  
  
    for (int i = 0; i < word.length(); i++) {  
        char ch = word.charAt(i);  
        Function function = k -> new Node();  
  
        node = node.getChildren().computeIfAbsent(ch, function);  
    }  
  
    node.setWord(true);  
}
```



The complexity of insertion is $O(n)$, where n represents the word size.

Finding in a Trie

Now, let's search for a word in a Trie:

1. Consider the current node as the root.
2. Loop the given word character by character (start from the first character).
3. For each character, check its presence in the Trie (in `Map<Character, Node>`).
4. If a character is not present, then return `false`.
5. Repeat from step 2 until the end of the word.
6. At the end of the word, return `true` if this was a word, or `false` if it was just a prefix.

In terms of code lines, we have the following:

```
public boolean contains(String word) {  
  
    Node node = root;  
  
    for (int i = 0; i < word.length(); i++) {  
        char ch = word.charAt(i);  
        node = node.getChildren().get(ch);  
    }  
}
```

```
        if (node == null) {
            return false;
        }

        return node.isWord();
    }
}
```



The complexity of finding is $O(n)$, where n represents the word size.

Deleting from a Trie

Finally, let's try to delete from a Trie:

1. Verify whether the given word is part of the Trie.
2. If it is part of the Trie, then simply remove it.

Deletion takes place in a bottom-up manner using recursion and following these rules:

- If the given word is not in the Trie, then nothing happens (return `false`)
- If the given word is unique (not part of another word), then delete all corresponding nodes (return `true`)
- If the given word is a prefix of another long word in the Trie, then set the leaf node flag to `false` (return `false`)
- If the given word has at least another word as a prefix, then delete the corresponding nodes from the end of the given word until the first leaf node of the longest prefix word (return `false`)

In terms of code lines, we have the following:

```
public boolean delete(String word) {
    return delete(root, word, 0);
}

private boolean delete(Node node, String word, int position) {

    if (word.length() == position) {
        if (!node.isWord()) {
            return false;
        }
    }
}
```

```
        node.setWord(false);

        return node.getChildren().isEmpty();
    }

    char ch = word.charAt(position);
    Node children = node.getChildren().get(ch);

    if (children == null) {
        return false;
    }

    boolean deleteChildren = delete(children, word, position + 1);

    if (deleteChildren && !children.isWord()) {
        node.getChildren().remove(ch);

        return node.getChildren().isEmpty();
    }

    return false;
}
```



The complexity of finding is $O(n)$, where n represents the word size.

Now, we can build a Trie as follows:

```
Trie trie = new Trie();
trie.insert/contains/delete(...);
```

125. Tuple

Basically, a tuple is a data structure consisting of multiple parts. Usually, a tuple has two or three parts. Typically, when more than three parts are needed, a dedicated class is a better choice.

Tuples are immutable and are used whenever we need to return multiple results from a method. For example, let's assume that we have a method that returns the minimum and maximum of an array. Normally, a method cannot return both, and using a tuple is a convenient solution.

Unfortunately, Java doesn't provide built-in tuple support. Nevertheless, Java comes with `Map.Entry<K, V>`, which is used to represent an entry from a `Map`. Moreover, starting with JDK 9, the `Map` interface was enriched with a method named `entry(K k, V v)`, which returns an unmodifiable `Map.Entry<K, V>` containing the given key and value.

For a tuple of two parts, we can write our method as follows:

```
public static <T> Map.Entry<T, T> array(
    T[] arr, Comparator<? super T> c) {

    T min = arr[0];
    T max = arr[0];

    for (T elem: arr) {
        if (c.compare(min, elem) > 0) {
            min = elem;
        } else if (c.compare(max, elem) < 0) {
            max = elem;
        }
    }

    return entry(min, max);
}
```

If this method lives in a class named `Bounds`, then we can call it as follows:

```
public class Melon {

    private final String type;
    private final int weight;

    // constructor, getters, equals(), hashCode(),
    // toString() omitted for brevity
}

Melon[] melons = {
    new Melon("Crenshaw", 2000), new Melon("Gac", 1200),
    new Melon("Bitter", 2200), new Melon("Hami", 800)
};

Comparator<Melon> byWeight = Comparator.comparing(Melon::getWeight);
Map.Entry<Melon, Melon> minmax = Bounds.array(melons, byWeight);

System.out.println("Min: " + minmax1.getKey()); // Hami(800g)
System.out.println("Max: " + minmax1.getValue()); // Bitter(2200g)
```

But we can write an implementation as well. A tuple with two parts is commonly named a *pair*; therefore, an intuitive implementation can be as follows:

```
public final class Pair<L, R> {

    final L left;
    final R right;

    public Pair(L left, R right) {
        this.left = left;
        this.right = right;
    }

    static <L, R> Pair<L, R> of (L left, R right) {

        return new Pair<>(left, right);
    }

    // equals() and hashCode() omitted for brevity
}
```

Now, we can rewrite our method that computes the minimum and maximum as follows:

```
public static <T> Pair<T, T> array(T[] arr, Comparator<? super T> c) {
    ...
    return Pair.of(min, max);
}
```

126. Union Find

The Union Find algorithm operates on a *disjoint-set* data structure.

A disjoint-set data structure defines sets of elements separated in certain disjoint subsets that are not overlapping. Graphically, we can represent a disjoint-set with three subsets, as in the following diagram:

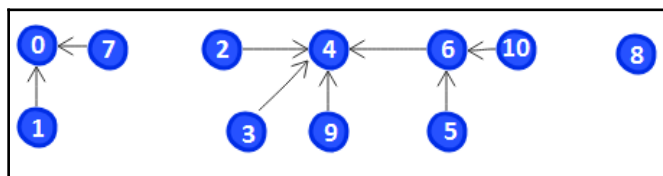

In the code, a disjoint-set is represented as follows:

- n is the total number of elements (for example, in the preceding diagram, n is 11).
- $rank$ is an array initialized with 0 that is useful to decide how to union two subsets with multiple elements (subsets with lower $rank$ become children of subsets with a higher $rank$).
- $parent$ is the array that allows us to build an array-based Union Find (initially, $parent[0] = 0; parent[1] = 1; \dots parent[10] = 10;$):

```
public DisjointSet(int n) {
    this.n = n;
    rank = new int[n];
    parent = new int[n];

    initializeDisjointSet();
}
```

Mainly, the Union Find algorithms should be capable of the following:

- Merging two subsets into a single subset
- Returning its subset for the given element (this is useful for finding elements that are in the same subset)

In order to store a disjoint-set data structure in memory, we can represent it as an array. Initially, at each index of the array, we store that index ($x[i] = i$). Each index can be mapped to a piece of meaningful information for us, but this is not mandatory. For example, such an array can be shaped as in the following diagram (initially, we have 11 subsets and each element is a parent of itself):

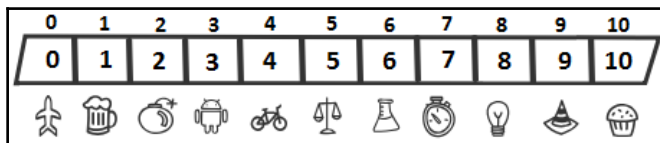

Or, if we use numbers, we can represent it in the following diagram:

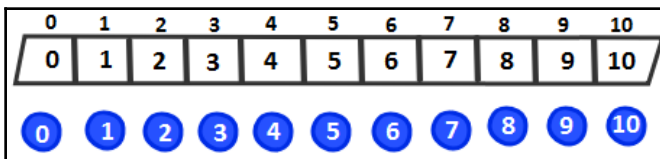

In terms of code lines, we have the following:

```
private void initializeDisjointSet () {
    for (int i = 0; i < n; i++) {
        parent[i] = i;
    }
}
```

Furthermore, we need to define our subsets via the *union* operation. We can define subsets via a sequence of (*parent*, *child*) pairs. For example, let's define the following three pairs—`union(0, 1)`; `union(4, 9)`; and `union(6, 5)`; . Each time an element (subset) becomes a child of another element (subset), it will modify its value to reflect the value of its parent, as in the following diagram:

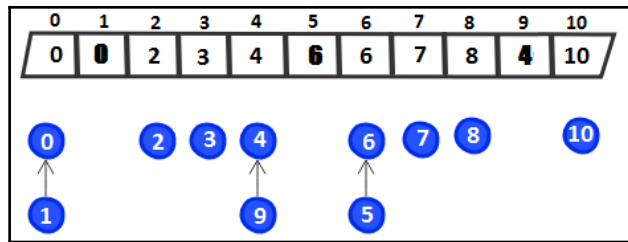

This process continues until we define all our subsets. For example, we can add more unions—`union(0, 7)`; `union(4, 3)`; `union(4, 2)`; `union(6, 10)`; and `union(4, 5)`; . This will result in the following graphical representation:

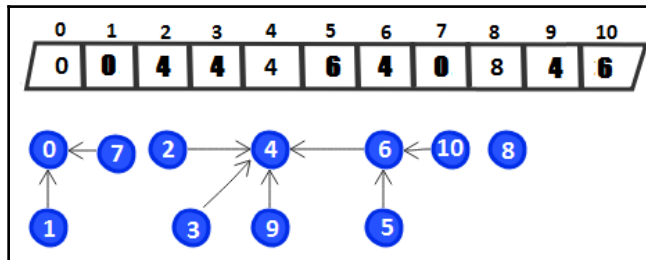

As a rule of thumb, it is advisable to union smaller subsets to larger subsets and not vice versa. For example, check the moment when we unify the subset that contains 4 with the subset that contains 5. At that moment, 4 is the parent of the subset and it has three children (2, 3, and 9), while 5 is next to 10, the two children of 6. So, the subset that contains 5 has three nodes (6, 5, 10), while the subset that contains 4 has four nodes (4, 2, 3, 9). So, 4 becomes the parent of 6 and, implicitly, the parent of 5.

In code lines, this is the job of the `rank[]` array:

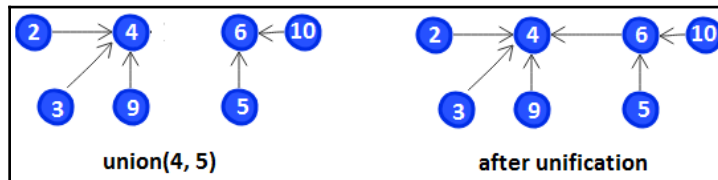

Let's now take a look at how to implement the find and union operation.

Implementing the find operation

Finding the subset of the given element is a recursive process that traverses the subset by following the parent elements until the current element is the parent of itself (root element):

```
public int find(int x) {
    if (parent[x] == x) {
        return x;
    } else {
        return find(parent[x]);
    }
}
```

Implementing the union operation

The *union* operation begins by fetching the root elements of the given subsets. Furthermore, if these two roots are different, they need to rely on their rank to decide which one will become the parent of the other one (the bigger rank becomes a parent). If they have the same rank, then choose one of them and increase its rank by 1:

```
public void union(int x, int y) {
    int xRoot = find(x);
    int yRoot = find(y);

    if (xRoot == yRoot) {
        return;
    }

    if (rank[xRoot] < rank[yRoot]) {
        parent[xRoot] = yRoot;
    }
}
```

```

    } else if (rank[yRoot] < rank[xRoot]) {
        parent[yRoot] = xRoot;
    } else {
        parent[yRoot] = xRoot;
        rank[xRoot]++;
    }
}

```

OK. Let's now define a disjoint set:

```

DisjointSet set = new DisjointSet(11);
set.union(0, 1);
set.union(4, 9);
set.union(6, 5);
set.union(0, 7);
set.union(4, 3);
set.union(4, 2);
set.union(6, 10);
set.union(4, 5);

```

And now let's play with it:

```

// is 4 and 0 friends => false
System.out.println("Is 4 and 0 friends: "
    + (set.find(0) == set.find(4)));

// is 4 and 5 friends => true
System.out.println("Is 4 and 5 friends: "
    + (set.find(4) == set.find(5)));

```

This algorithm can be optimized by compressing the paths between elements. For example, check the following diagram:

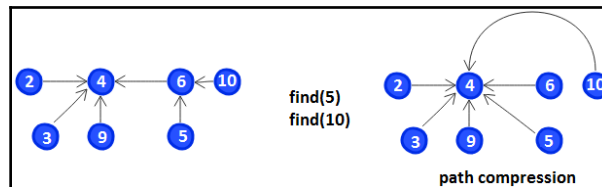

On the left-hand side, in trying to find the parent of 5, you must pass through 6 until it reaches 4. Similarly, in trying to find the parent of 10, you must pass through 6 until it reaches 4. However, on the right-hand side, we compress the paths of 5 and 10 by linking them directly to 4. This time, we can find the parent of 5 and 10 without passing through intermediary elements.

Path compression can take place in relation to the `find()` operation, as follows:

```
public int find(int x) {
    if (parent[x] != x) {
        return parent[x] = find(parent[x]);
    }
    return parent[x];
}
```

The code bundled to this book contains both applications, with and without path compression.

127. Fenwick Tree or Binary Indexed Tree

The **Fenwick Tree (FT)** or **Binary Indexed Tree (BIT)** is an array built to store sums corresponding to another given array. The built array has the same size as the given array, and each position (or node) of the built array stores the sum of some elements of the given array. Since BIT stores partial sums of the given array, it is a very efficient solution for computing the sum of elements of the given array between two given indexes (range sum/queries) by avoiding looping between the indexes and computing the sum.

The BIT can be constructed in linear time or $O(n \log n)$. Obviously, we prefer it in linear time, so let's see how we can do this. We begin with the given (original) array that can be (the subscripts represent the index in the array):

3₍₁₎, 1₍₂₎, 5₍₃₎, 8₍₄₎, 12₍₅₎, 9₍₆₎, 7₍₇₎, 13₍₈₎, 0₍₉₎, 3₍₁₀₎, 1₍₁₁₎, 4₍₁₂₎, 9₍₁₃₎, 0₍₁₄₎, 11₍₁₅₎, 5₍₁₆₎

The idea of building the BIT relies on the **Least Significant Bit (LSB)** concept. More precisely, let's assume that we are currently dealing with the element from the index, a . Then, the value immediately above us must be at index b , where $b = a + LSB(a)$. In order to apply the algorithm, the value from index 0 must be 0; therefore the array that we operate is as follows:

0₍₀₎, 3₍₁₎, 1₍₂₎, 5₍₃₎, 8₍₄₎, 12₍₅₎, 9₍₆₎, 7₍₇₎, 13₍₈₎, 0₍₉₎, 3₍₁₀₎, 1₍₁₁₎, 4₍₁₂₎, 9₍₁₃₎, 0₍₁₄₎, 11₍₁₅₎, 5₍₁₆₎

Now, let's apply a few steps of the algorithm and let's populate the BIT with sums. At index 0 in BIT, we have 0. Furthermore, we use the $b = a + LSB(a)$ formula to compute the remaining sums, as follows:

1. $a = 1$: If $a = 1 = 00001_2$, then $b = 00001_2 + 00001_2 = 1 + 1 = 2 = 00010_2$. We say that 2 is responsible for a (which is 1). Therefore, in BIT, at index 1, we store the value 3, and, at index 2, we store the value sum, $3 + 1 = 4$.
2. $a = 2$: If $a = 2 = 00010_2$, then $b = 00010_2 + 00010_2 = 2 + 2 = 4 = 00100_2$. We say that 4 is responsible for a (which is 2). Therefore, in BIT, at index 4, we store the value sum, $8 + 4 = 12$.
3. $a = 3$: If $a = 3 = 00011_2$, then $b = 00011_2 + 00001_2 = 3 + 1 = 4 = 00100_2$. We say that 4 is responsible for a (which is 3). Therefore, in BIT, at index 4, we store the value sum, $12 + 5 = 17$.
4. $a = 4$: If $a = 4 = 00100_2$, then $b = 00100_2 + 00100_2 = 4 + 4 = 8 = 01000_2$. We say that 8 is responsible for a (which is 4). Therefore, in BIT, at index 8, we store the value sum, $13 + 17 = 30$.

The algorithm will continue in the same manner until the BIT is complete. In a graphical representation, our case can be shaped as follows:

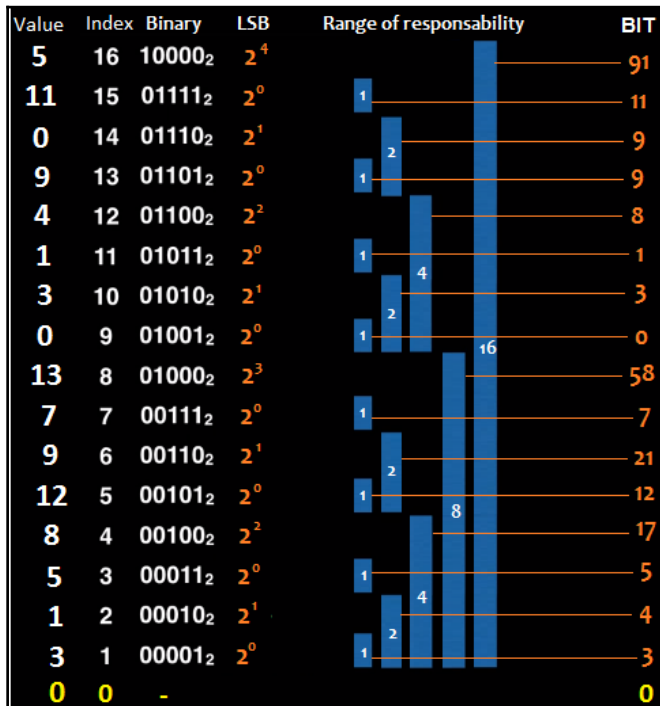



If a computed point of an index is out of bounds, then simply ignore it.

In code lines, the preceding flow can be shaped as follows (values are the given array):

```
public class FenwickTree {

    private final int n;
    private long[] tree;
    ...

    public FenwickTree(long[] values) {

        values[0] = 0 L;
        this.n = values.length;
        tree = values.clone();

        for (int i = 1; i < n; i++) {

            int parent = i + lsb(i);
            if (parent < n) {
                tree[parent] += tree[i];
            }
        }

        private static int lsb(int i) {

            return i & -i;

            // or
            // return Integer.lowestOneBit(i);
        }

        ...
    }
}
```

Now, the BIT is ready and we can perform updates and range queries.

For example, in order to perform range sums, we have to fetch the corresponding ranges and total them up. Consider a few examples on the right-hand side of the following diagram to quickly understand this process:

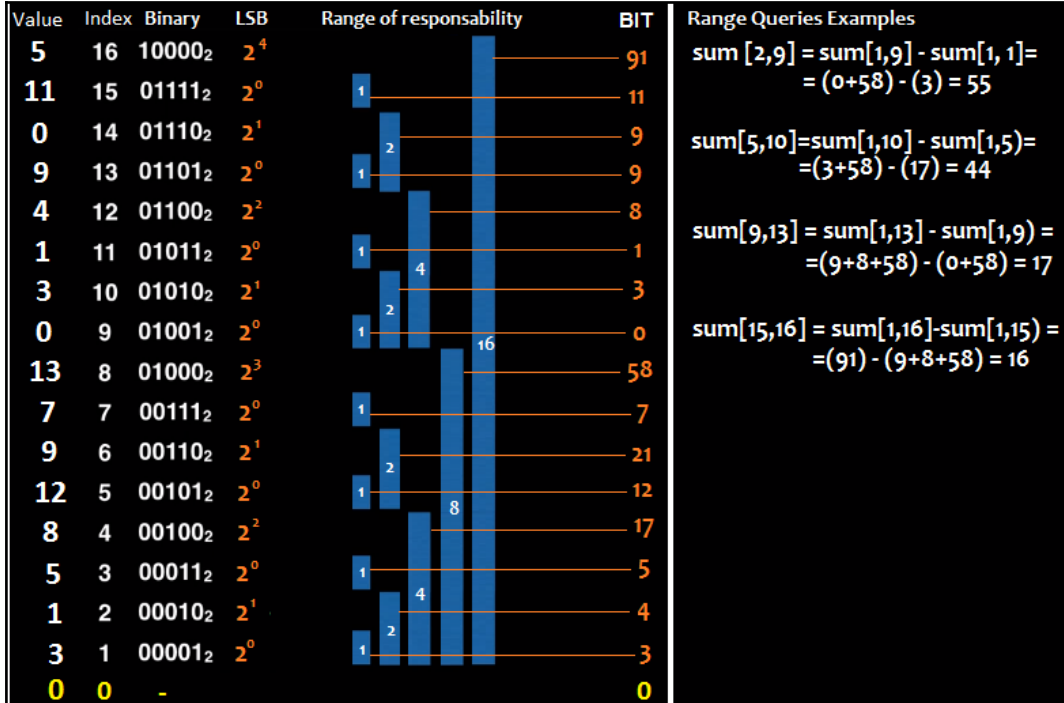

In terms of code lines, this can be easily shaped as follows:

```
public long sum(int left, int right) {
    return prefixSum(right) - prefixSum(left - 1);
}

private long prefixSum(int i) {
    long sum = 0L;

    while (i != 0) {
        sum += tree[i];
        i &= ~lsb(i); // or, i -= lsb(i);
    }

    return sum;
}
```

Moreover, we can add a new value:

```
public void add(int i, long v) {  
  
    while (i < n) {  
        tree[i] += v;  
        i += lsb(i);  
    }  
}
```

And we can also set a new value to a certain index:

```
public void set(int i, long v) {  
    add(i, v - sum(i, i));  
}
```

Having all these features in place, we can create the BIT for our array as follows:

```
FenwickTree tree = new FenwickTree(new long[] {  
    0, 3, 1, 5, 8, 12, 9, 7, 13, 0, 3, 1, 4, 9, 0, 11, 5  
});
```

And then we can play with it:

```
long sum29 = tree.sum(2, 9); // 55  
tree.set(4, 3);  
tree.add(4, 5);
```

128. Bloom filter

The Bloom filter is a fast and memory-efficient data structure capable of providing a probabilistic answer to the question *Is value X in the given set?*

Commonly, this algorithm is useful when the set is huge and most searching algorithms are facing memory and speed issues.

The speed and memory efficiency of the Bloom filter come from the fact that this data structure relies on an array of bits (for example, `java.util.BitSet`). Initially, the bits of this array are set to 0 or false.

The array of bits is the first main ingredient of the Bloom filter. The second main ingredient consists of one or more hash functions. Ideally, these are *pairwise independent* and *uniformly distributed* hash functions. Also, it is very important to be extremely fast. Murmur, the fnv series, and HashMix are some of the hash functions that respect these constraints to an acceptable extent for being used by the Bloom filter.

Now, when we add an element to the Bloom filter, we need to hash this element (pass it through each available hash function) and set the bits in the bit array at the index of those hashes to 1 or true.

The following snippet of code should clarify the main idea:

```
private BitSet bitset; // the array of bits
private static final Charset CHARSET = StandardCharsets.UTF_8;
...
public void add(T element) {

    add(element.toString().getBytes(CHARSET));
}

public void add(byte[] bytes) {

    int[] hashes = hash(bytes, numberOfHashFunctions);

    for (int hash: hashes) {
        bitset.set(Math.abs(hash % bitSetSize), true);
    }

    numberOfAddedElements++;
}
```

Now, when we search for an element, we pass this element through the same hash functions. Furthermore, we check whether the resultant values are marked in the array of bits as 1 or true. If they are not, then the element is not in the set for sure. But if they are, then we know with a certain probability that the element is in the set. This is not 100% certain since another element or combination of elements may have been flipped up those bits. Wrong answers are known as *false positives*.

In terms of code lines, we have the following:

```
private BitSet bitset; // the array of bits
private static final Charset CHARSET = StandardCharsets.UTF_8;
...

public boolean contains(T element) {
```

```

return contains(element.toString().getBytes(CHARSET));
}

public boolean contains(byte[] bytes) {

    int[] hashes = hash(bytes, numberOfHashFunctions);

    for (int hash: hashes) {
        if (!bitset.get(Math.abs(hash % bitSetSize))) {

            return false;
        }
    }

    return true;
}

```

In a graphical representation, we can represent a Bloom filter with an array of bits of size 11 and three hash functions as follows (we have added two elements):

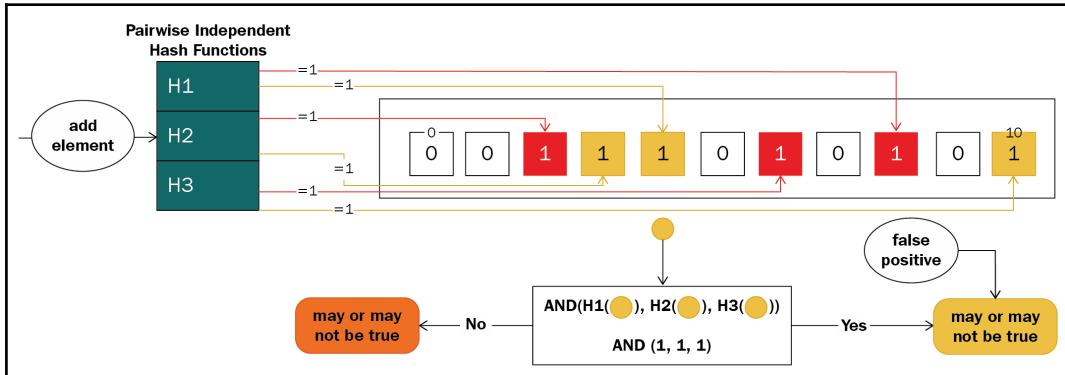

Obviously, we want to reduce the number of *false positives* as much as possible. While we cannot totally eliminate them, we can still affect their rate by joggling with the size of the bit array, the number of hash functions, and the number of elements in the set.

The following mathematical formulas can be used to shape the optimal Bloom filter:

- Number of items in the filter (can be estimated based on m , k , and p):

$$n = \text{ceil}(m / (-k / \log(1 - \exp(\log(p) / k))));$$

- Probability of *false positives*, a fraction between 0 and 1, or a number indicating 1-in-p:

```
p = pow(1 - exp(-k / (m / n)), k);
```

- Number of bits in the filter (or size in terms of KB, KiB, MB, Mb, GiB, and so on):

```
m = ceil((n * log(p)) / log(1 / pow(2, log(2))));
```

- Number of hash functions (can be estimated based on m and n):

```
k = round((m / n) * log(2));
```



As a rule of thumb, a larger filter will have fewer *false positives* than a smaller one. Moreover, by increasing the number of hash functions, we obtain fewer *false positives*, but we slow down the filter and will fill it up quickly. The performance of the Bloom filter is $O(h)$, where h is the number of hash functions.

In the code bundled to this book, there is an implementation of the Bloom filter using hash functions based on SHA-256 and murmur. Since this code is too big to be listed in this book, please consider as a starting point the example from the `Main` class.

Summary

This chapter covered 30 problems involving arrays, collections, and several data structures. While the problems covering arrays and collections are part of daily work, the problems covering data structures have introduced a few less well-known (but powerful) data structures, such as FT, Union Find, and Trie.

Download the applications from this chapter to see the results and to examine additional details.

6

Java I/O Paths, Files, Buffers, Scanning, and Formatting

This chapter includes 20 problems that involve Java I/O for files. From manipulating, walking, and watching paths to streaming files and efficient ways for reading/writing text and binary files, we will cover problems that Java developers may face on a day-to-day basis.

With the skills you will have gained from this chapter, you will be able to tackle most of the common problems that involve Java I/O files. The wide range of topics in this chapter will provide a plethora of information about how Java tackles I/O tasks.

Problems

Take a look at the following problems in order to test your Java I/O programming prowess. I strongly encourage you to give each problem a try before you turn to the solutions and download the example programs:

129. **Creating file paths:** Write several examples of creating several kinds of file paths (for example, absolute paths, relative paths, and so on).
130. **Converting file paths:** Write several examples of converting file paths (for example, converting a file path into a string, URI, file, and so on).
131. **Joining file paths:** Write several examples of joining (combining) file paths. Define a fixed path and append other different paths to it (or replace a part of it with other paths).
132. **Constructing a path between two locations:** Write several examples that construct a relative path between two given paths (from one path to another).
133. **Comparing file paths:** Write several examples of comparing the given file paths.

134. **Walking paths:** Write a program that visits all the files within a directory, including subdirectories. Moreover, write a program that searches a file by name, deletes a directory, moves a directory, and copies a directory.
135. **Watching paths:** Write several programs that watch changes that occur on a certain path (for example, create, delete, and modify).
136. **Streaming a file's content:** Write a program that streams the content of the given file.
137. **Searching for files/folders in a file tree:** Write a program that searches for the given files/folders in the given file tree.
138. **Reading/writing text files efficiently:** Write several programs to exemplify different approaches for reading and writing a text file in an efficient manner.
139. **Reading/writing binary files efficiently:** Write several programs to exemplify different approaches for reading and writing a binary file in an efficient manner.
140. **Searching in big files:** Write a program that efficiently searches the given string in a big file.
141. **Reading a JSON/CSV file as an object:** Write a program that reads the given JSON/CSV file as an object (POJO).
142. **Working with temporary files/folders:** Write several programs for working with temporary files/folders.
143. **Filtering files:** Write several user-defined filters for files.
144. **Discovering mismatches between two files:** Write a program that discovers the mismatches between two files at the byte level.
145. **Circular byte buffer:** Write a program that represents an implementation of a circular byte buffer.
146. **Tokenizing files:** Write several snippets of code to exemplify different techniques of tokenizing a file content.
147. **Writing formatted output directly to a file:** Write a program that formats the given numbers (integers and doubles) and outputs them to a file.
148. **Working with Scanner:** Write several snippets of code to reveal `Scanner` capabilities.

Solutions

The following sections describe the solutions to the preceding problems. Remember that there usually isn't a single correct way to solve a particular problem. Also, remember that the explanations that are shown here only include the most interesting and important details that are needed to solve the problems. You can download the example solutions to view additional details and experiment with the programs from <https://github.com/PacktPublishing/Java-Coding-Problems>.

129. Creating file paths

Starting with JDK 7, we can create a file path via the NIO.2 API. More precisely, a file path can be easily defined via the `Path` and `Paths` APIs.

The `Path` class is a programmatic representation of a path in a filesystem. The path string contains the following information:

- The filename
- The directories list
- The OS-dependent file delimiter (for example, a forward slash `/` on Solaris and Linux and a backslash `\` on Microsoft Windows)
- Other allowed characters, for example, the `.` (current directory) and `..` (parent directory) notations



The `Path` class works with files in different filesystems (`FileSystem`) that can use different storage places (`FileStore` is the underlying storage).

A common solution for defining a `Path` is to call one of the `get()` methods of the `Paths` helper class. Another solution relies on the `FileSystems.getDefault().getPath()` method.

A `Path` resides in a filesystem—a filesystem stores and organizes files or some form of media, generally on one or more hard drives, in such a way that they can be easily retrieved. The filesystem can be obtained through the `final` class `java.nio.file.FileSystems`, which is used to get an instance of `java.nio.file.FileSystem`. The default `FileSystem` of the JVM (commonly known as the default filesystem of the operating system) can be obtained via the `FileSystems().getDefault()` method. Once we know the filesystem and the location of a file (or directory/folder), we can create a `Path` object for it.

Another approach consists of creating a `Path` from a **Uniform Resource Identifier (URI)**. Java wraps a URI via the `URI` class; then, we can obtain a URI from a `String` via the `URI.create(String uri)` method. Furthermore, the `Paths` class provides a `get()` method that takes a URI object as an argument and returns the corresponding `Path`.

Starting with JDK 11, we can create a `Path` via two `of()` methods. One of them converts a URI into a `Path`, while the other one converts a path-string, or a sequence of strings, joined as a path-string.

In the upcoming sections, we'll take a look at the various ways we can create paths.

Creating a path relative to the file store root

A path that's relative to the current file store root (for example, `C:/`) must start with the file delimiter. In the following examples, if the current file store root is `C`, then the absolute path is `C:\learning\packt\JavaModernChallenge.pdf`:

```
Path path = Paths.get("/learning/packt/JavaModernChallenge.pdf");
Path path = Paths.get("/learning", "packt/JavaModernChallenge.pdf");

Path path = Path.of("/learning/packt/JavaModernChallenge.pdf");
Path path = Path.of("/learning", "packt/JavaModernChallenge.pdf");

Path path = FileSystems.getDefault()
    .getPath("/learning/packt", "JavaModernChallenge.pdf");
Path path = FileSystems.getDefault()
    .getPath("/learning/packt/JavaModernChallenge.pdf");

Path path = Paths.get(
    URI.create("file:///learning/packt/JavaModernChallenge.pdf"));
Path path = Path.of(
    URI.create("file:///learning/packt/JavaModernChallenge.pdf"));
```

Creating a path relative to the current folder

When we create a path that's relative to the current working folder, the path should *not* start with the file delimiter. If the current folder is named `books` and is under the C root, then the absolute path that's returned by the following snippet of code will be `C:\books\learning\packt\JavaModernChallenge.pdf`:

```
Path path = Paths.get("learning/packt/JavaModernChallenge.pdf");
Path path = Paths.get("learning", "packt/JavaModernChallenge.pdf");

Path path = Path.of("learning/packt/JavaModernChallenge.pdf");
Path path = Path.of("learning", "packt/JavaModernChallenge.pdf");

Path path = FileSystems.getDefault()
    .getPath("learning/packt", "JavaModernChallenge.pdf");
Path path = FileSystems.getDefault()
    .getPath("learning/packt/JavaModernChallenge.pdf");
```

Creating an absolute path

Creating an absolute path can be accomplished by explicitly specifying the root directory and all other subdirectories that contain the file or folder, as shown in the following examples (`C:\learning\packt\JavaModernChallenge.pdf`):

```
Path path = Paths.get("C:/learning/packt", "JavaModernChallenge.pdf");
Path path = Paths.get(
    "C:", "learning/packt", "JavaModernChallenge.pdf");
Path path = Paths.get(
    "C:", "learning", "packt", "JavaModernChallenge.pdf");
Path path = Paths.get("C:/learning/packt/JavaModernChallenge.pdf");
Path path = Paths.get(
    System.getProperty("user.home"), "downloads", "chess.exe");

Path path = Path.of(
    "C:", "learning/packt", "JavaModernChallenge.pdf");
Path path = Path.of(
    System.getProperty("user.home"), "downloads", "chess.exe");

Path path = Paths.get(URI.create(
    "file:///C:/learning/packt/JavaModernChallenge.pdf"));
Path path = Path.of(URI.create(
    "file:///C:/learning/packt/JavaModernChallenge.pdf"));
```

Creating a path using shortcuts

We understand shortcuts to be the `.` (current directory) and `..` (parent directory) notations. This kind of path can be normalized via the `normalize()` method. This method eliminates redundancies such as `.` and `directory/..`:

```
Path path = Paths.get(
    "C:/learning/packt/chapters/../JavaModernChallenge.pdf")
    .normalize();
Path path = Paths.get(
    "C:/learning/./packt/chapters/../JavaModernChallenge.pdf")
    .normalize();

Path path = FileSystems.getDefault()
    .getPath("/learning/./packt", "JavaModernChallenge.pdf")
    .normalize();

Path path = Path.of(
    "C:/learning/packt/chapters/../JavaModernChallenge.pdf")
    .normalize();
Path path = Path.of(
    "C:/learning/./packt/chapters/../JavaModernChallenge.pdf")
    .normalize();
```



Without normalization, the redundant parts of the path will not be removed.

For creating paths that are 100% compatible with the current operating system, we can rely on `FileSystems.getDefault().getPath()`, or a combination of `File.separator` (system-dependent default name separator character) and `File.listRoots()` (the available filesystem roots). For relative paths, we can rely on the following examples:

```
private static final String FILE_SEPARATOR = File.separator;
```

Alternatively, we can rely on `getSeparator()`:

```
private static final String FILE_SEPARATOR
    = FileSystems.getDefault().getSeparator();

// relative to current working folder
Path path = Paths.get("learning",
    "packt", "JavaModernChallenge.pdf");
Path path = Path.of("learning",
```

```
"packt", "JavaModernChallenge.pdf");
Path path = Paths.get(String.join(FILE_SEPARATOR, "learning",
"packt", "JavaModernChallenge.pdf"));
Path path = Path.of(String.join(FILE_SEPARATOR, "learning",
"packt", "JavaModernChallenge.pdf"));

// relative to the file store root
Path path = Paths.get(FILE_SEPARATOR + "learning",
"packt", "JavaModernChallenge.pdf");
Path path = Path.of(FILE_SEPARATOR + "learning",
"packt", "JavaModernChallenge.pdf");
```

We can also do the same for absolute paths:

```
Path path = Paths.get(File.listRoots()[0] + "learning",
"packt", "JavaModernChallenge.pdf");
Path path = Path.of(File.listRoots()[0] + "learning",
"packt", "JavaModernChallenge.pdf");
```

The list of root directories can be obtained via `FileSystems` as well:

```
FileSystems.getDefault().getRootDirectories()
```

130. Converting file paths

Converting a file path into a `String`, `URI`, `File`, and so on is a common task that can occur in a wide range of applications. Let's consider the following file path:

```
Path path = Paths.get("/learning/packt", "JavaModernChallenge.pdf");
```

Now, based on JDK 7 and the NIO.2 API, let's see how we can convert a `Path` into a `String`, a `URI`, an absolute path, a *real* path, and a file:

- Converting a `Path` into a `String` is as simple as calling (explicitly or automatically) the `Path.toString()` method. Notice that if the path was obtained via the `FileSystem.getPath()` method, then the path-string returned by `toString()` may differ from the initial `String` that was used to create the path:

```
// \learning\packt\JavaModernChallenge.pdf
String pathToString = path.toString();
```

- Converting a `Path` into a `URI` (browser format) can be accomplished via the `Path.toURI()` method. The returned `URI` wraps a path-string that can be used in the address bar of a web browser:

```
// file:///D:/learning/packt/JavaModernChallenge.pdf
URI pathToURI = path.toUri();
```

Let's say that we want to extract the filename present in a `URI/URL` as `Path` (this is a common scenario to encounter). In such cases, we can rely on the following snippets of code:

```
// JavaModernChallenge.pdf
URI uri = URI.create(
    "https://www.learning.com/packt/JavaModernChallenge.pdf");
Path URIToPath = Paths.get(uri.getPath()).getFileName();

// JavaModernChallenge.pdf
URL url = new URL(
    "https://www.learning.com/packt/JavaModernChallenge.pdf");
Path URLToPath = Paths.get(url.getPath()).getFileName();
```

Conversion of paths can be done as follows:

- Converting a relative `Path` into an absolute `Path` can be done via the `Path.toAbsolutePath()` method. If the `Path` is already absolute, then the same result will be returned:

```
// D:\learning\packt\JavaModernChallenge.pdf
Path pathToAbsolutePath = path.toAbsolutePath();
```

- Converting a `Path` into a *real* `Path` can be accomplished via the `Path.toRealPath()` method and its result is dependent on the implementation. If the file that's being pointed to doesn't exist, then this method will throw an `IOException`. But, as a rule of thumb, the result of calling this method is an absolute path without redundant elements (normalized). This method gets an argument that indicates how *symbolic links* should be treated. By default, if the filesystem supports *symbolic links*, then this method will try to resolve them. If you wish to ignore the *symbolic links*, simply pass the `LinkOption.NOFOLLOW_LINKS` constant to the method. Moreover, the path name elements will represent the actual name of the directories and the file.

For example, let's consider the following `Path` and the result of calling this method (notice that we have intentionally added several redundant elements and capitalized the `PACKT` folder):

```
Path path = Paths.get(
    "/learning/books/../PACKT/./", "JavaModernChallenge.pdf");

// D:\learning\packt\JavaModernChallenge.pdf
Path realPath = path.toRealPath(LinkOption.NOFOLLOW_LINKS);
```

- Converting a `Path` into a file can be done via the `Path.toFile()` method. For converting a file into a `Path`, we can rely on the `File.toPath()` method:

```
File pathToFile = path.toFile();
Path fileToPath = pathToFile.toPath();
```

131. Joining file paths

Joining (or combining) file paths means defining a fixed root path and appending to it a partial path or replacing a part of it (for example, a filename needs to be replaced with another filename). Basically, this is a handy technique when we want to create new paths that share a common fixed part.

This can be accomplished via NIO.2 and the `Path.resolve()` and `Path.resolveSibling()` methods.

Let's consider the following fixed root path:

```
Path base = Paths.get("D:/learning/packt");
```

Let's also assume that we want to obtain the `Path` for two different books:

```
// D:\learning\packt\JBossTools3.pdf
Path path = base.resolve("JBossTools3.pdf");

// D:\learning\packt\MasteringJSF22.pdf
Path path = base.resolve("MasteringJSF22.pdf");
```

We can use this feature to loop a set of files; for example, let's loop a `String[]` of books:

```
Path basePath = Paths.get("D:/learning/packt");
String[] books = {
    "Book1.pdf", "Book2.pdf", "Book3.pdf"
```

```
};  
  
for (String book: books) {  
    Path nextBook = basePath.resolve(book);  
    System.out.println(nextBook);  
}
```

Sometimes, the fixed root path contains the filename as well:

```
Path base = Paths.get("D:/learning/packt/JavaModernChallenge.pdf");
```

This time, we can replace the name of the file (`JavaModernChallenge.pdf`) with another name via the `resolveSibling()` method. This method resolves the given path against this path's parent path, as shown in the following example:

```
// D:\learning\packt\MasteringJSF22.pdf  
Path path = base.resolveSibling("MasteringJSF22.pdf");
```

If we bring the `Path.getParent()` method into the discussion and we chain the `resolve()` and `resolveSibling()` methods, then we can create more complex paths, as shown in the following example:

```
// D:\learning\publisher\MyBook.pdf  
Path path = base.getParent().resolveSibling("publisher")  
    .resolve("MyBook.pdf");
```

The `resolve()/resolveSibling()` method comes in two flavors – `resolve(String other) / resolveSibling(String other)` and `resolve(Path other) / resolveSibling(Path other)`, respectively.

132. Constructing a path between two locations

Constructing a relative path between two locations is a job for the `Path.relativeTo()` method.

Basically, the resulted relative path (returned by `Path.relativeTo()`) starts from a path and ends on another path. This is a powerful feature that allows us to navigate between different locations using relative paths that are resolved against the previous paths.

Let's consider the following two paths:

```
Path path1 = Paths.get("JBossTools3.pdf");
Path path2 = Paths.get("JavaModernChallenge.pdf");
```

Notice that `JBossTools3.pdf` and `JavaModernChallenge.pdf` are siblings. This means that we can navigate from one to another by going up one level and then down one level. This navigation case is revealed by the following examples as well:

```
// ..\JavaModernChallenge.pdf
Path path1ToPath2 = path1.relativeTo(path2);

// ..\JBossTools3.pdf
Path path2ToPath1 = path2.relativeTo(path1);
```

Another common case involves a common root element:

```
Path path3 = Paths.get("/learning/packt/2003/JBossTools3.pdf");
Path path4 = Paths.get("/learning/packt/2019");
```

So, `path3` and `path4` share the same common root element, `/learning`. For navigating from `path3` to `path4`, we need to go up two levels and down one level. In addition, for navigating from `path4` to `path3`, we need to go up one level and down two levels. Check out the following code:

```
// ...\2019
Path path3ToPath4 = path3.relativeTo(path4);

// ..\2003\JBossTools3.pdf
Path path4ToPath3 = path4.relativeTo(path3);
```



Both paths must include a root element. Accomplishing this requirement does not guarantee success because the construction of the relative path is implementation-dependent.

133. Comparing file paths

Depending on how we perceive the equality between two file paths, there are several solutions to this problem. Mainly, `Path` equality can be verified in different ways for different goals.

Let's assume that we have the following three paths (consider reproducing `path3` on your computer):

```
Path path1 = Paths.get("/learning/packt/JavaModernChallenge.pdf");
Path path2 = Paths.get("/LEARNING/PACKT/JavaModernChallenge.pdf");
Path path3 = Paths.get("D:/learning/packt/JavaModernChallenge.pdf");
```

In the following sections, we'll take a look at the different methods that are used to compare file paths.

Path.equals()

Is `path1` equal to `path2`? Or, is `path2` equal to `path3`? Well, if we perform these tests via `Path.equals()`, then a possible result will reveal that `path1` is equal to `path2`, but `path2` is not equal to `path3`:

```
boolean path1EqualsPath2 = path1.equals(path2); // true
boolean path2EqualsPath3 = path2.equals(path3); // false
```

The `Path.equals()` method follows the `Object.equals()` specification. While this method doesn't access the filesystem, equality depends on the filesystem implementation. For example, some filesystem implementations may compare paths in a case-sensitive manner, while others may ignore case.

Paths representing the same file/folder

However, this probably isn't the kind of comparison that we want. It is more meaningful to say that two paths are equal if they are the same file or folder. This can be accomplished via the `Files.isSameFile()` method. This method acts in two steps:

1. First, it calls `Path.equals()`, and, if this method returns `true`, then the paths are equal and need no further action.
2. Second, if `Path.equals()` returns `false`, then it checks if both paths represent the same file/folder (depending on the implementation, this action may need to open/access both files, so the files must exist in order to avoid an `IOException`).

```
//true
boolean path1IsSameFilePath2 = Files.isSameFile(path1, path2);
//true
boolean path1IsSameFilePath3 = Files.isSameFile(path1, path3);
```



```
//true
boolean path2IsSameFilePath3 = Files.isSameFile(path2, path3);
```

Lexicographical comparison

If all we want is a lexicographical comparison of the paths, then we can rely on the `Path.compareTo()` method (this can be useful for sorting).

This method returns the following information:

- 0 if the paths are equal
- A value less than zero if the first path is lexicographically less than the argument path
- A value greater than zero if the first path is lexicographically greater than the argument path:

```
int path1compareToPath2 = path1.compareTo(path2); // 0
int path1compareToPath3 = path1.compareTo(path3); // 24
int path2compareToPath3 = path2.compareTo(path3); // 24
```

Note that you may obtain different values than in the preceding example.

Furthermore, in your business logic, it is important to rely on their meaning and not on their value (for example, say `if (path1compareToPath3 > 0) { ... }` and `avoid if (path1compareToPath3 == 24) { ... }`).

Partial comparing

Partial comparing is achievable via the `Path.startsWith()` and `Path.endsWith()` methods. Using these methods, we can test whether the current path starts/ends with the given path:

```
boolean sw = path1.startsWith("/learning/packt"); // true
boolean ew = path1.endsWith("JavaModernChallenge.pdf"); // true
```

134. Walking paths

There are different solutions for walking (or visiting) paths, and one of them is provided by the NIO.2 API via the `FileVisitor` interface.

This interface exposes a set of methods that represent checkpoints in the recursive process of visiting the given path. By overriding these checkpoints, we are allowed to interfere in this process. We can process the currently visited file/folder and decide what should happen further via the `FileVisitResult` enumeration, which contains the following constants:

- `CONTINUE`: The traversal process should continue (visit next file, folder, skip a failure, and so on)
- `SKIP_SIBLINGS`: The traversal process should continue without visiting the siblings of the current file/folder
- `SKIP_SUBTREE`: The traversal process should continue without visiting the entries in the current folder
- `TERMINATE`: The traversal should brutally terminate

The methods that are exposed by `FileVisitor` are as follows:

- `FileVisitResult visitFile(T file, BasicFileAttributes attrs)` throws `IOException`: Automatically called for each visited file/folder
- `FileVisitResult preVisitDirectory(T dir, BasicFileAttributes attrs)` throws `IOException`: Automatically called for a folder before visiting its content
- `FileVisitResult postVisitDirectory(T dir, IOException exc)` throws `IOException`: Automatically called after the content in the directory (including descendants) is visited or, during the iteration of the folder, an I/O error occurred or the visit was programmatically aborted
- `FileVisitResult visitFileFailed(T file, IOException exc)` throws `IOException`: Automatically called when the file cannot be visited (accessed) for different reasons (for example, the file's attributes cannot be read or a folder cannot be opened)

Ok; so far, so good! Let's continue with several practical examples.

Trivial traversal of a folder

Implementing the `FileVisitor` interface requires that we override its four methods. However, NIO.2 comes with a built-in simple implementation of this interface called `SimpleFileVisitor`. For simple cases, extending this class is more convenient than implementing `FileVisitor` since it allows us to override only the necessary methods.

For example, let's assume that we store our e-courses in the subfolders of the `D:/learning` folder, and we want to visit each of these subfolders via the `FileVisitor` API. If something goes wrong during the iteration of a subfolder, we will simply throw the reported exception.

In order to shape this behavior, we need to override the `postVisitDirectory()` method, as follows:

```
class PathVisitor extends SimpleFileVisitor<Path> {  
  
    @Override  
    public FileVisitResult postVisitDirectory(  
        Path dir, IOException ioe) throws IOException {  
  
        if (ioe != null) {  
            throw ioe;  
        }  
  
        System.out.println("Visited directory: " + dir);  
  
        return FileVisitResult.CONTINUE;  
    }  
}
```

In order to use the `PathVisitor` class, we just need to set up the path and call one of the `Files.walkFileTree()` methods, as follows (the flavor of `walkFileTree()` that's used here gets the starting file/folder and the corresponding `FileVisitor`):

```
Path path = Paths.get("D:/learning");  
PathVisitor visitor = new PathVisitor();  
  
Files.walkFileTree(path, visitor);
```

By using the preceding code, we will receive the following output:

```
Visited directory: D:\learning\books\ajax  
Visited directory: D:\learning\books\angular  
...
```

Searching for a file by name

Searching a certain file on a computer is a common task. Typically, we rely on tools that are provided by the operating system or additional tools, but if we want to accomplish this programmatically (for example, we may want to write a file search tool with special features), then `FileVisitor` can help us achieve this in a pretty straightforward way. The stub of this application is listed as follows:

```
public class SearchFileVisitor implements FileVisitor {

    private final Path fileNameToSearch;
    private boolean fileFound;
    ...

    private boolean search(Path file) throws IOException {

        Path fileName = file.getFileName();

        if (fileNameToSearch.equals(fileName)) {
            System.out.println("Searched file was found: " +
                fileNameToSearch + " in " + file.toRealPath().toString());

            return true;
        }

        return false;
    }
}
```

Let's take a look at the main checkpoints and the implementation of searching a file by name:

- `visitFile()` is our main checkpoint. Once we have control, we can query the currently visited file for its name, extension, attributes, and so on. This information is needed in order to draw a comparison with the same information on the searched file. For example, we compare the names, and at first match, we `TERMINATE` the search. But if we search for more such files (if we know that there is more than one), then we can return `CONTINUE`:

```
@Override
public FileVisitResult visitFile(
    Object file, BasicFileAttributes attrs) throws IOException {

    fileFound = search((Path) file);
}
```

```

        if (!fileFound) {
            return FileVisitResult.CONTINUE;
        } else {
            return FileVisitResult.TERMINATE;
        }
    }
}

```



The `visitFile()` method cannot be used for finding folders. Use the `preVisitDirectory()` or `postVisitDirectory()` methods instead.

- `visitFileFailed()` is the second important checkpoint. When this method is invoked, we know that something went wrong while visiting the current file. We prefer to ignore any such issues and `CONTINUE` the search. It's pointless to stop the search process:

```

@Override
public FileVisitResult visitFileFailed(
    Object file, IOException ioe) throws IOException {
    return FileVisitResult.CONTINUE;
}

```

The `preVisitDirectory()` and `postVisitDirectory()` methods don't carry any important tasks, so we can skip them for brevity.

In order to start the search, we rely on another flavor of the `Files.walkFileTree()` method. This time, we specify the start point of the search (for example, all roots), the options that were used during searching (for example, follow *symbolic links*), the maximum number of directory levels to visit (for example, `Integer.MAX_VALUE`), and the `FileVisitor` (for example, `SearchFileVisitor`):

```

Path searchFile = Paths.get("JavaModernChallenge.pdf");

SearchFileVisitor searchFileVisitor
    = new SearchFileVisitor(searchFile);

EnumSet opts = EnumSet.of(FileVisitOption.FOLLOW_LINKS);
Iterable<Path> roots = FileSystems.getDefault().getRootDirectories();

for (Path root: roots) {
    if (!searchFileVisitor.isFileFound()) {
        Files.walkFileTree(root, opts,
            Integer.MAX_VALUE, searchFileVisitor);
    }
}

```

If you take a look at the code that's bundled with this book, the preceding search traverses all the roots (directories) of your computer in a recursive approach. The preceding example can be easily adapted for searching by extension, by a pattern, or to look inside files from some text.

Deleting a folder

Before attempting to delete a folder, we must delete all the files from it. This statement is very important since it doesn't allow us to simply call the `delete()/deleteIfExists()` methods for a folder that contains files. An elegant solution to this problem relies on a `FileVisitor` implementation that starts from the following stub:

```
public class DeleteFileVisitor implements FileVisitor {
    ...
    private static boolean delete(Path file) throws IOException {
        return Files.deleteIfExists(file);
    }
}
```

Let's take a look at the main checkpoints and the implementation of deleting a folder:

- `visitFile()` is the perfect place for deleting each file from the given folder or subfolder (if a file cannot be deleted, then we simply pass it to the next file, but feel free to adapt the code to suit your needs):

```
@Override
public FileVisitResult visitFile(
    Object file, BasicFileAttributes attrs) throws IOException {
    delete((Path) file);

    return FileVisitResult.CONTINUE;
}
```

- A folder can be deleted only if it is empty, and so `postVisitDirectory()` is the perfect place to do this (we ignore any potential `IOException`, but feel free to adapt the code to suit your needs (for example, log the names of the folders that couldn't be deleted or throw an exception to stop the process)):

```
@Override
public FileVisitResult postVisitDirectory(
```

```
        Object dir, IOException ioe) throws IOException {  
            delete((Path) dir);  
            return FileVisitResult.CONTINUE;  
        }  
    }
```

In `visitFileFailed()` and `preVisitDirectory()`, we simply return `CONTINUE`.

For deleting the folder, in `D:/learning`, we can call `DeleteFileVisitor`, as follows:

```
Path directory = Paths.get("D:/learning");  
DeleteFileVisitor deleteFileVisitor = new DeleteFileVisitor();  
EnumSet opts = EnumSet.of(FileVisitOption.FOLLOW_LINKS);  
  
Files.walkFileTree(directory, opts,  
    Integer.MAX_VALUE, deleteFileVisitor);
```



By combining `SearchFileVisitor` and `DeleteFileVisitor`, we can obtain a search-delete application.

Copying a folder

In order to copy a file, we can rely on the `Path copy(Path source, Path target, CopyOption options) throws IOException` method. This method copies a file to the target file with the `options` parameter specifying how the copy is performed.

By combining the `copy()` method with a custom `FileVisitor`, we can copy an entire folder (including all its content). The stub code of this custom `FileVisitor` is listed as follows:

```
public class CopyFileVisitor implements FileVisitor {  
  
    private final Path copyFrom;  
    private final Path copyTo;  
    ...  
  
    private static void copySubTree(  
        Path copyFrom, Path copyTo) throws IOException {  
  
        Files.copy(copyFrom, copyTo,
```

```
        REPLACE_EXISTING, COPY_ATTRIBUTES);  
    }  
}
```

Let's take a look at the main checkpoints and the implementation of copying a folder (note that we will act indulgently by copying anything that we can and avoid throwing exceptions, but feel free to adapt the code to suit your needs):

- Before copying any files from a source folder, we need to copy the source folder itself. Copying a source folder (empty or not) will result in an empty target folder. This is the perfect task to accomplish in the `preVisitDirectory()` method:

```
@Override  
public FileVisitResult preVisitDirectory(  
    Object dir, BasicFileAttributes attrs) throws IOException {  
  
    Path newDir = copyTo.resolve(  
        copyFrom.relativeTo((Path) dir));  
  
    try {  
        Files.copy((Path) dir, newDir,  
            REPLACE_EXISTING, COPY_ATTRIBUTES);  
    } catch (IOException e) {  
        System.err.println("Unable to create "  
            + newDir + " [" + e + "]);  
  
        return FileVisitResult.SKIP_SUBTREE;  
    }  
  
    return FileVisitResult.CONTINUE;  
}
```

- The `visitFile()` method is the perfect place to copy each file:

```
@Override  
public FileVisitResult visitFile(  
    Object file, BasicFileAttributes attrs) throws IOException {  
  
    try {  
        copySubTree((Path) file, copyTo.resolve(  
            copyFrom.relativeTo((Path) file)));  
    } catch (IOException e) {  
        System.err.println("Unable to copy "  
            + copyFrom + " [" + e + "]);  
    }  
}
```



```
        return FileVisitResult.CONTINUE;
    }
}
```

- Optionally, we can preserve the attributes of the source directory. This can be accomplished only after the files have been copied into the `postVisitDirectory()` method (for example, let's preserve the last modified time):

```
@Override
public FileVisitResult postVisitDirectory(
    Object dir, IOException ioe) throws IOException {

    Path newDir = copyTo.resolve(
        copyFrom.relativeTo((Path) dir));

    try {
        FileTime time = Files.getLastModifiedTime((Path) dir);
        Files.setLastModifiedTime(newDir, time);
    } catch (IOException e) {
        System.err.println("Unable to preserve
            the time attribute to: " + newDir + " [" + e + "]");
    }

    return FileVisitResult.CONTINUE;
}
}
```

- If a file cannot be visited, then `visitFileFailed()` will be invoked. This is a good moment to detect *circular links* and report them. By following links (`FOLLOW_LINKS`), we can encounter cases where the file tree has a *circular link* to a parent folder. These cases are reported via `FileSystemLoopException` exceptions in `visitFileFailed()`:

```
@Override
public FileVisitResult visitFileFailed(
    Object file, IOException ioe) throws IOException {

    if (ioe instanceof FileSystemLoopException) {
        System.err.println("Cycle was detected: " + (Path) file);
    } else {
        System.err.println("Error occurred, unable to copy:"
            + (Path) file + " [" + ioe + "]");
    }

    return FileVisitResult.CONTINUE;
}
}
```

Let's copy the `D:/learning/packt` folder to `D:/e-courses`:

```
Path copyFrom = Paths.get("D:/learning/packt");
Path copyTo = Paths.get("D:/e-courses");

CopyFileVisitor copyFileVisitor
    = new CopyFileVisitor(copyFrom, copyTo);

EnumSet opts = EnumSet.of(FileVisitOption.FOLLOW_LINKS);

Files.walkFileTree(copyFrom, opts, Integer.MAX_VALUE,
    copyFileVisitor);
```



By combining `CopyFileVisitor` and `DeleteFileVisitor`, we can easily shape an application for moving folders. In the code bundled with this book, there is a complete example of moving folders as well. Based on the expertise we've accumulated so far, the code should be pretty accessible without further details.

Pay attention when logging information regarding files (for example, as in the case of handling exceptions) since files (for example, their names, paths, and attributes) may contain sensitive information that can be exploited in a malicious fashion.

JDK 8, `Files.walk()`

Starting with JDK 8, the `Files` class has been enriched with two `walk()` methods. These methods return a `Stream` that is lazily populated with `Path`. It does this by walking the file tree that's rooted at a given starting file using the given maximum depth and options:

```
public static Stream<Path> walk(
    Path start, FileVisitOption...options)
    throws IOException

public static Stream<Path> walk(
    Path start, int maxDepth, FileVisitOption...options)
    throws IOException
```

For example, let's display all the paths from `D:/learning` that start with `D:/learning/books/cdi`:

```
Path directory = Paths.get("D:/learning");

Stream<Path> streamOfPath = Files.walk(
    directory, FileVisitOption.FOLLOW_LINKS);

streamOfPath.filter(e -> e.startsWith("D:/learning/books/cdi"))
    .forEach(System.out::println);
```

Now, let's compute the size in bytes for a folder (for example, `D:/learning`):

```
long folderSize = Files.walk(directory)
    .filter(f -> f.toFile().isFile())
    .mapToLong(f -> f.toFile().length())
    .sum();
```



This method is *weakly consistent*. It doesn't freeze the file tree during the iteration process. The potential updates to the file tree may or may not be reflected.

135. Watching paths

Watching paths for changes is just one of the thread-safe goals that can be accomplished via the JDK 7 NIO.2, low-level `WatchService` API.

In a nutshell, a path can be watched for changes by following two major steps:

1. Register a folder (or folders) to be watched for different kinds of event types.
2. When a registered event type is detected by `WatchService`, it is handled in a separate thread, so the watch service is not blocked.

At the API level, the starting point is the `WatchService` interface. This interface comes in different flavors for different file/operating systems.

This interface works hand-in-hand with two main classes. Together, they provide a convenient approach that you can implement to add watching capabilities to a certain context (for example, to the filesystem):

- `Watchable`: Any object that implements this interface is a *watchable object*, and so it can be watched for changes (for example, `Path`)

- `StandardWatchEventKinds`: This class defines the standard *event types* (these are the event types that we can register for notifications):
 - `ENTRY_CREATE`: Directory entry created
 - `ENTRY_DELETE`: Directory entry deleted
 - `ENTRY_MODIFY`: Directory entry modified; what is considered as a modification is somewhat platform-specific, but actually modifying the content of a file should always trigger this event type
 - `OVERFLOW`: A special event to indicate that events may have been lost or discarded

`WatchService` is known as the *watcher*, and we say that the *watcher* watches *watchables*. In the following examples, `WatchService` will be created through the `FileSystem` class and will watch the registered `Path`.

Watching a folder for changes

Let's start with a stub method that gets the `Path` of the folder that should be monitored for changes as an argument:

```
public void watchFolder(Path path)
    throws IOException, InterruptedException {
    ...
}
```

`WatchService` will notify us when any of the `ENTRY_CREATE`, `ENTRY_DELETE`, and `ENTRY_MODIFY` event types occur on the given folder. For this, we need to follow several steps:

1. Create `WatchService` so that we can monitor the filesystem—this is accomplished via `FileSystem.newWatchService()`, as follows:

```
WatchService watchService
    = FileSystems.getDefault().newWatchService();
```

2. Register the event types that should be notified—this is accomplished via `Watchable.register()`:

```
path.register(watchService,
    StandardWatchEventKinds.ENTRY_CREATE,
    StandardWatchEventKinds.ENTRY_MODIFY,
    StandardWatchEventKinds.ENTRY_DELETE);
```



For each *watchable object*, we receive a registration token as a `WatchKey` instance (*watch key*). We receive this *watch key* at registration time, but `WatchService` returns the relevant `WatchKey` every time an event is triggered.

3. Now, we need to wait for incoming events. This is accomplished in an infinite loop (when an event occurs, the *watcher* is responsible for queuing the corresponding *watch key* for later retrieval and changing its status to *signaled*):

```
while (true) {  
    // process the incoming event types  
}
```

4. Now, we need to retrieve a *watch key* – there are at least three methods dedicated to retrieving a *watch key*:
 - `poll()`: Returns the next key from the queue and removes it (alternatively, it will return `null` if no key is present).
 - `poll(long timeout, TimeUnit unit)`: Returns the next key from the queue and removes it; if no key is present, then it waits for the specified timeout and tries again. If a key still isn't available, then it returns `null`.
 - `take()`: Returns the next key from the queue and removes it; if no key is present, then it will wait until a key is queued or the infinite loop is stopped:

```
WatchKey key = watchService.take();
```

5. Next, we need to retrieve the pending events of a *watch key*. A *watch key* in *signaled* status has at least one pending event; we can retrieve and remove all the events of a certain *watch key* via the `WatchKey.pollEvents()` method (each event is represented by a `WatchEvent` instance):

```
for (WatchEvent<?> watchEvent : key.pollEvents()) {  
    ...  
}
```

6. Then, we retrieve information about the *event type*. For each event, we can obtain different information (for example, the event type, number of occurrences, and context-specific information (for example, the filename that caused the event)), which is useful for processing the event):

```
Kind<?> kind = watchEvent.kind();
WatchEvent<Path> watchEventPath = (WatchEvent<Path>)
watchEvent;
Path filename = watchEventPath.context();
```

7. Next, we reset the *watch key*. A *watch key* has a status that can be either *ready* (initial status at creation), *signaled*, or *invalid*. Once *signaled*, a *watch key* remains like this until we call the `reset()` method, which attempts to put it back in the *ready* status to accept the event's state. If the transition from *signaled* to *ready* (resume waiting events) was successful, then the `reset()` method returns `true`; otherwise, it returns `false`, which means that the *watch key* may be *invalid*. A *watch key* can be in an *invalid* state if it is no longer active (inactivity can be caused by explicitly calling the `close()` method of the *watch key*, closing the watcher, the directory was deleted, and so on):

```
boolean valid = key.reset();

if (!valid) {
    break;
}
```



When there is a single *watch key* in an *invalid* state, then there is no reason to stay in the infinite loop. Simply call `break` to jump out of the loop.

8. Finally, we close the *watcher*. This can be accomplished by explicitly calling the `close()` method of `WatchService` or relying on *try-with-resources*, as follows:

```
try (WatchService watchService
    = FileSystems.getDefault().newWatchService()) {
    ...
}
```

The code that's bundled with this book glues all these snippets of code into a single class named `FolderWatcher`. The result will be a *watcher* that's capable of reporting the create, delete, and modify events that occurred on the specified path.

In order to watch the path, that is, `D:/learning/packt`, we just call the `watchFolder()` method:

```
Path path = Paths.get("D:/learning/packt");

FolderWatcher watcher = new FolderWatcher();
watcher.watchFolder(path);
```

Running the application will display the following message:

```
Watching: D:\learning\packt
```

Now, we can create, delete, or modify a file directly under this folder and check the notifications. For example, if we simply copy-paste a file called `resources.txt`, then the output will be as follows:

```
ENTRY_CREATE -> resources.txt
ENTRY_MODIFY -> resources.txt
```

In the end, don't forget to stop the application, since it will run indefinitely (in theory).

Starting with this application, the source code bundled with this book comes with two more applications. One of them is a simulation of a video capture system, while the other is a simulation of a printer tray watcher. By relying on the knowledge that we've accumulated during this section, it should be pretty straightforward to understand these two applications without further details.

136. Streaming a file's content

Streaming a file's content is a problem that can be solved via JDK 8 using the `Files.lines()` and `BufferedReader.lines()` methods.

`Stream<String> Files.lines(Path path, Charset cs)` reads all the lines from a file as a `Stream`. This happens lazily, as the stream is consumed. During the execution of the Terminal stream operation, the file's content should not be modified; otherwise, the result is undefined.

Let's take a look at an example that reads the content of the `D:/learning/packt/resources.txt` file and displays it on the screen (notice that we run the code in a *try-with-resources*, and so the file is closed by closing the stream):

```
private static final String FILE_PATH
    = "D:/learning/packt/resources.txt";
```

```
...
try (Stream<String> filesStream = Files.lines(
    Paths.get(FILE_PATH), StandardCharsets.UTF_8)) {

    filesStream.forEach(System.out::println);
} catch (IOException e) {
    // handle IOException if needed, otherwise remove the catch block
}
```

A similar method without arguments is available in the `BufferedReader` class:

```
try (BufferedReader brStream = Files.newBufferedReader(
    Paths.get(FILE_PATH), StandardCharsets.UTF_8)) {

    brStream.lines().forEach(System.out::println);
} catch (IOException e) {
    // handle IOException if needed, otherwise remove the catch block
}
```

137. Searching for files/folders in a file tree

Searching for files or folders in a file tree is a common task that's needed in a lot of situations. Thanks to JDK 8 and the new `Files.find()` method, we can accomplish this pretty easily.

The `Files.find()` method returns a `Stream<Path>` which is lazily populated with the paths that match the provided finding constraints:

```
public static Stream<Path> find(
    Path start,
    int maxDepth,
    BiPredicate<Path, BasicFileAttributes > matcher,
    FileVisitOption...options
) throws IOException
```

This method acts as the `walk()` method, and so it traverses the current file tree, starting from the given path (`start`), and reaching the maximum given depth (`maxDepth`). During the iteration of the current file tree, this method applies the given predicate (`matcher`). Via this predicate, we specify the constraints that must be matched by each file that goes in the final stream. Optionally, we can specify a set of visiting options (`options`).

```
Path startPath = Paths.get("D:/learning");
```

Let's take a look at some examples that are meant to clarify the usage of this method:

- Find all the files ending with the `.properties` extension and follow the *symbolic links*:

```
Stream<Path> resultAsStream = Files.find(
    startPath,
    Integer.MAX_VALUE,
    (path, attr) -> path.toString().endsWith(".properties"),
    FileVisitOption.FOLLOW_LINKS
);
```

- Find all the regular files whose names start with `application`:

```
Stream<Path> resultAsStream = Files.find(
    startPath,
    Integer.MAX_VALUE,
    (path, attr) -> attr.isRegularFile() &&
    path.getFileName().toString().startsWith("application")
);
```

- Find all the directories that were created after 16 March 2019:

```
Stream<Path> resultAsStream = Files.find(
    startPath,
    Integer.MAX_VALUE,
    (path, attr) -> attr.isDirectory() &&
    attr.creationTime().toInstant()
    .isAfter(LocalDate.of(2019, 3, 16).atStartOfDay()
    .toInstant(ZoneOffset.UTC))
);
```

If we prefer to express the constraints as an expression (for example, a regular expression), then we can use the `PathMatcher` interface. This interface comes with a method called `matches(Path path)`, which can tell if the given path matches this matcher's pattern.

A `FileSystem` implementation supports the *glob* and *regex* syntaxes (and may support others) via `FileSystem.getPathMatcher(String syntaxPattern)`. The constraints take the form of `syntax:pattern`.

Based on `PathMatcher`, we can write helper methods that are capable of covering a wide range of constraints. For example, the following helper method only fetches files that respect the given constraint as a `syntax:pattern`:

```
public static Stream<Path> fetchFilesMatching(Path root,
      String syntaxPattern) throws IOException {

    final PathMatcher matcher
        = root.getFileSystem().getPathMatcher(syntaxPattern);

    return Files.find(root, Integer.MAX_VALUE, (path, attr)
        -> matcher.matches(path) &&& !attr.isDirectory());
}
```

Finding all Java files via the *glob* syntax can be achieved as follows:

```
Stream<Path> resultAsStream
    = fetchFilesMatching(startPath, "glob:**/*.*java");
```

If all we want to do is list the files from the current folder (without any constraints and a single level deep), then we can rely on the `Files.list()` method, as shown in the following example:

```
try (Stream<Path> allfiles = Files.list(startPath)) {
    ...
}
```

138. Reading/writing text files efficiently

In Java, reading files efficiently is a matter of choosing the right approach. For a better understanding of the following example, let's assume that our platform's default charset is UTF-8. Programmatically, the platform's default charset can be obtained via `Charset.defaultCharset()`.

First, we need to distinguish between raw binary data and text files from a Java perspective. Dealing with raw binary data is the job of two abstract classes, that is, `InputStream` and `OutputStream`. For streaming files of raw binary data, we focus on the `FileInputStream` and `FileOutputStream` classes, which read/write a byte (8 bits) at a time. For famous types of binary data, we also have dedicated classes (for example, an audio file should be processed via `AudioInputStream` instead of `FileInputStream`).

While these classes are doing a spectacular job for raw binary data, they are not good for text files because they are slow and may produce wrong outputs. This becomes pretty clear if we think that streaming a text file via these classes means that each byte is read from the text file and processed (the same tedious flow is needed for writing a byte). Moreover, if a char has more than 1 byte, then it is possible to see some weird characters. In other words, decoding and encoding 8 bits independent of the charset (for example, Latin, Chinese, and so on) may produce unexpected output.

For example, let's suppose that we have the following Chinese poem saved in UTF-16:

```
Path chineseFile = Paths.get("chinese.txt");
和毛泽东 << 重上井冈山 >>. 严永欣, 一九八八年.
久有归天愿
终过鬼门关
千里来寻归宿
...
```

The following code will not display it as expected:

```
try (InputStream is = new FileInputStream(chineseFile.toString())) {

    int i;
    while ((i = is.read()) != -1) {
        System.out.print((char) i);
    }
}
```

So, in order to fix this, we should specify the proper charset. While `InputStream` doesn't have support for this, we can rely on `InputStreamReader` (or `OutputStreamReader`, respectively). This class is a bridge from raw byte streams to character streams and allows us to specify the charset:

```
try (InputStreamReader isr = new InputStreamReader(
    new FileInputStream(chineseFile.toFile()),
    StandardCharsets.UTF_16)) {

    int i;
    while ((i = isr.read()) != -1) {
        System.out.print((char) i);
    }
}
```

Things are back on track but are still slow! Now, the application can read more than one single byte at once (depending on the charset) and decodes them into characters using the specified charset. But a few more bytes are still slow.

`InputStreamReader` is a bridge between raw binary data streams and character streams. But Java provides the `FileReader` class as well. Its goal is to eliminate this bridge for character streams that are represented by character files.

For text files, we have a dedicated class known as the `FileReader` class (or `FileWriter`, respectively). This class reads 2 or 4 bytes (depending on the used charset) at a time. Actually, before JDK 11, `FileReader` didn't support an explicit charset. It simply used the platform's default charset. This isn't good for us because the following code will not produce the expected output:

```
try (FileReader fr = new FileReader(chineseFile.toFile())) {

    int i;
    while ((i = fr.read()) != -1) {
        System.out.print((char) i);
    }
}
```

But starting with JDK 11, the `FileReader` class was enriched with two more constructors that support an explicit charset:

- `FileReader(File file, Charset charset)`
- `FileReader(String fileName, Charset charset)`

This time, we can rewrite the preceding snippet of code and obtain the expected output:

```
try (FileReader frch = new FileReader(
    chineseFile.toFile(), StandardCharsets.UTF_16)) {

    int i;
    while ((i = frch.read()) != -1) {
        System.out.print((char) i);
    }
}
```

Reading 2 or 4 bytes at a time is still better than reading 1, but it's still slow. Moreover, notice that the preceding solutions use an `int` to store the retrieved char, and we need to explicitly cast it to `char` in order to display it. Basically, the retrieved char from the input file is converted into an `int`, and we convert it back into a `char`.

This is where *buffering streams* enter the scene. Think about what happens when we watch a video online. While we are watching the video, the browser is buffering the incoming bytes ahead of time. This way, we have a smooth experience because we can see the bytes from the buffer and avoid the potential interruptions caused by seeing the bytes during network transfer:

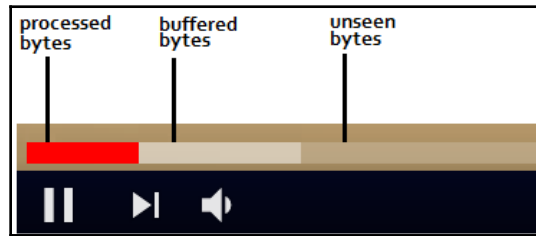

The same principle is used by classes such as `BufferedInputStream`, `BufferedOutputStream` for raw binary streams and `BufferedReader`, and `BufferedWriter` for character streams. The main idea is to buffer the data before processing. This time, `FileReader` returns the data to `BufferedReader` until it hits the end of the line (for example, `\n` or `\n\r`). `BufferedReader` uses RAM to store the buffered data:

```
try (BufferedReader br = new BufferedReader(
    new FileReader(chineseFile.toFile(), StandardCharsets.UTF_16))) {

    String line;
    // keep buffering and print
    while ((line = br.readLine()) != null) {
        System.out.println(line);
    }
}
```

So, instead of reading 2 bytes at a time, we read a complete line, which is much faster. This is a really efficient way of reading text files.



For further optimization, we can set the size of the buffer via dedicated constructors.

Notice that the `BufferedReader` class knows how to create and deal with the buffer in the context of the incoming data but is independent of the source of data. In our example, the source of data is `FileReader`, which is a file, but the same `BufferedReader` can buffer data from different sources (for example, network, file, console, printer, sensor, and so on). In the end, we read what we buffered.

The preceding examples represent the main approaches for reading text files in Java. Starting with JDK 8, a new set of methods were added to make our life easier. In order to create a `BufferedReader`, we can rely on `Files.newBufferedReader(Path path, Charset cs)` as well:

```
try (BufferedReader br = Files.newBufferedReader(
    chineseFile, StandardCharsets.UTF_16)) {

    String line;
    while ((line = br.readLine()) != null) {
        System.out.println(line);
    }
}
```

For `BufferedWriter`, we have `Files.newBufferedWriter()`. The advantage of these methods is that they support `Path` directly.

For fetching a text file's content as a `Stream<T>`, take a look at the problem in the *Streaming a file's content* section.

Another valid solution that may cause eye strain is as follows:

```
try (BufferedReader br = new BufferedReader(new InputStreamReader(
    new FileInputStream(chineseFile.toFile()),
    StandardCharsets.UTF_16)) {

    String line;
    while ((line = br.readLine()) != null) {
        System.out.println(line);
    }
}
```

Now, it's time to talk about reading text files directly into memory.

Reading text files in memory

The `Files` class comes with two methods that can read an entire text file in memory. One of them is `List<String> readAllLines(Path path, Charset cs)`:

```
List<String> lines = Files.readAllLines(
    chineseFile, StandardCharsets.UTF_16);
```

Moreover, we can read the entire content in a `String` via `Files.readString(Path path, Charset cs)`:

```
String content = Files.readString(chineseFile,
    StandardCharsets.UTF_16);
```

While these methods are very convenient for relatively small files, they are not a good choice for large files. Trying to fetch large files in memory is prone to `OutOfMemoryError` and, obviously, will consume a lot of memory. Alternatively, in the case of huge files (for example, 200 GB), we can focus on memory-mapped files (`MappedByteBuffer`). `MappedByteBuffer` allows us to create and modify huge files and treat them as very big arrays. They look like they are in memory, even if they are not. Everything happens at the native level:

```
// or use, Files.newByteChannel()
try (FileChannel fileChannel = (FileChannel.open(chineseFile,
    EnumSet.of(StandardOpenOption.READ)))) {

    MappedByteBuffer mbBuffer = fileChannel.map(
        FileChannel.MapMode.READ_ONLY, 0, fileChannel.size());

    if (mbBuffer != null) {
        String bufferContent
            = StandardCharsets.UTF_16.decode(mbBuffer).toString();

        System.out.println(bufferContent);
        mbBuffer.clear();
    }
}
```

For huge files, it is advisable to traverse the buffer with a fixed size, as follows:

```
private static final int MAP_SIZE = 5242880; // 5 MB in bytes

try (FileChannel fileChannel = (FileChannel.open(chineseFile,
    EnumSet.of(StandardOpenOption.READ)))) {

    int position = 0;
    long length = fileChannel.size();
```

```
while (position < length) {
    long remaining = length - position;
    int bytestomap = (int) Math.min(MAP_SIZE, remaining);

    MappedByteBuffer mbBuffer = fileChannel.map(
        MapMode.READ_ONLY, position, bytestomap);

    ... // do something with the current buffer

    position += bytestomap;
}
}
```



JDK 13 prepares the release of non-volatile MappedByteBuffers. Stay tuned!

Writing text files

For each class/method dedicated to reading a text file (for example, `BufferedReader` and `readString()`) Java provides its counterpart for writing a text file (for example, `BufferedWriter` and `writeString()`). Here is an example of writing a text file via `BufferedWriter`:

```
Path textFile = Paths.get("sample.txt");

try (BufferedWriter bw = Files.newBufferedWriter(
    textFile, StandardCharsets.UTF_8, StandardOpenOption.CREATE,
    StandardOpenOption.WRITE)) {
    bw.write("Lorem ipsum dolor sit amet, ... ");
    bw.newLine();
    bw.write("sed do eiusmod tempor incididunt ...");
}
```

A very handy method for writing an `Iterable` into a text file is `Files.write(Path path, Iterable<? extends CharSequence> lines, Charset cs, OpenOption... options)`. For example, let's write the content of a list into a text file (each element from the list is written on a line in the file):

```
List<String> linesToWrite = Arrays.asList("abc", "def", "ghi");
Path textFile = Paths.get("sample.txt");
Files.write(textFile, linesToWrite, StandardCharsets.UTF_8,
    StandardOpenOption.CREATE, StandardOpenOption.WRITE);
```

Finally, to write a `String` to a file, we can rely on the `Files.writeString(Path path, CharSequence csq, OpenOption... options)` method:

```
Path textFile = Paths.get("sample.txt");

String lineToWrite = "Lorem ipsum dolor sit amet, ...";
Files.writeString(textFile, lineToWrite, StandardCharsets.UTF_8,
    StandardOpenOption.CREATE, StandardOpenOption.WRITE);
```



Via `StandardOpenOption`, we can control how the file is opened. In the preceding examples, the files were created if they didn't exist (`CREATE`) and they were opened for write access (`WRITE`). Many other options are available (for example, `APPEND`, `DELETE_ON_CLOSE`, and so on).

Finally, writing a text file via `MappedByteBuffer` can be accomplished as follows (this can be useful for writing huge text files):

```
Path textFile = Paths.get("sample.txt");
CharBuffer cb = CharBuffer.wrap("Lorem ipsum dolor sit amet, ...");

try (FileChannel fileChannel = (FileChannel) Files.newByteChannel(
    textFile, EnumSet.of(StandardOpenOption.CREATE,
        StandardOpenOption.READ, StandardOpenOption.WRITE)) {

    MappedByteBuffer mbBuffer = fileChannel
        .map(FileChannel.MapMode.READ_WRITE, 0, cb.length());

    if (mbBuffer != null) {
        mbBuffer.put(StandardCharsets.UTF_8.encode(cb));
    }
}
```

139. Reading/writing binary files efficiently

In the previous problem, *Reading/writing text files efficiently*, we talked about *buffering streaming* (for a clear picture, consider reading that problem before this one). Things work the same for binary files too, and so we can jump directly into some examples.

Let's consider the following binary file and its size in bytes:

```
Path binaryFile = Paths.get(
    "build/classes/modern/challenge/Main.class");

int fileSize = (int) Files.readAttributes(
    binaryFile, BasicFileAttributes.class).size();
```

We can read the file's content in a `byte []` via `FileInputStream` (this doesn't use buffering):

```
final byte[] buffer = new byte[fileSize];
try (InputStream is = new FileInputStream(binaryFile.toString())) {

    int i;
    while ((i = is.read(buffer)) != -1) {
        System.out.print("\nReading ... ");
    }
}
```

However, the preceding example isn't very efficient. Achieving high efficiency when it comes to reading the `buffer.length` bytes from this input stream into a byte array can be done via `BufferedInputStream`, as follows:

```
final byte[] buffer = new byte[fileSize];

try (BufferedInputStream bis = new BufferedInputStream(
    new FileInputStream(binaryFile.toFile()))) {

    int i;
    while ((i = bis.read(buffer)) != -1) {
        System.out.print("\nReading ... " + i);
    }
}
```

`FileInputStream` can be obtained via the `Files.newInputStream()` method as well. The advantage of this method consists of the fact that it supports `Path` directly:

```
final byte[] buffer = new byte[fileSize];

try (BufferedInputStream bis = new BufferedInputStream(
    Files.newInputStream(binaryFile))) {

    int i;
    while ((i = bis.read(buffer)) != -1) {
        System.out.print("\nReading ... " + i);
    }
}
```

If the file is too large to fit in a buffer of the file size, then it is preferable to read it via a smaller buffer with a fixed size (for example, 512 bytes) and the `read()` flavors, which are as follows:

- `read(byte[] b)`
- `read(byte[] b, int off, int len)`
- `readNBytes(byte[] b, int off, int len)`
- `readNBytes(int len)`



The `read()` method without arguments will read the input stream byte by byte. This is the most inefficient way, especially without using buffering.

Alternatively, if our goal is to read the input stream as a byte array, we can rely on `ByteArrayInputStream` (it uses an internal buffer, so there is no need to use `BufferedInputStream`):

```
final byte[] buffer = new byte[fileSize];

try (ByteArrayInputStream bais = new ByteArrayInputStream(buffer)) {

    int i;
    while ((i = bais.read(buffer)) != -1) {
        System.out.print("\nReading ... ");
    }
}
```

The preceding approaches are a good fit for raw binary data, but sometimes, our binary files contain certain data (for example, ints, floats, and so on). In such cases, `DataInputStream` and `DataOutputStream` provide convenient methods for reading and writing certain data types. Let's consider that we have a file, `data.bin`, that contains float numbers. We can efficiently read it as follows:

```
Path dataFile = Paths.get("data.bin");

try (DataInputStream dis = new DataInputStream(
    new BufferedInputStream(Files.newInputStream(dataFile)))) {

    while (dis.available() > 0) {
        float nr = dis.readFloat();
        System.out.println("Read: " + nr);
    }
}
```



These two classes are just two of the *data filters* provided by Java. For an overview of all the supported *data filters*, check out the subclasses of `FilterInputStream`. Moreover, the `Scanner` class is a good alternative for reading certain types of data. Check out the problem in the *Working with Scanner* section for more information.

Now, let's see how we can read binary files directly into memory.

Reading binary files into memory

Reading an entire binary file into memory can be accomplished via `Files.readAllBytes()`:

```
byte[] bytes = Files.readAllBytes(binaryFile);
```

A similar method exists in the `InputStream` class as well.

While these methods are very convenient for relatively small files, they are not a good choice for large files. Trying to fetch large files into memory is prone to OOM errors and, obviously, will consume a lot of memory. Alternatively, in the case of huge files (e.g., 200 GB), we can focus on memory-mapped files (`MappedByteBuffer`). `MappedByteBuffer` allows us to create and modify huge files and treat them as a very big array. They look like they are in memory even if they are not. Everything happens at the native level:

```
try (FileChannel fileChannel = (FileChannel.open(binaryFile,
    EnumSet.of(StandardOpenOption.READ)))) {

    MappedByteBuffer mbBuffer = fileChannel.map(
        FileChannel.MapMode.READ_ONLY, 0, fileChannel.size());

    System.out.println("\nRead: " + mbBuffer.limit() + " bytes");
}
```

For huge files it is advisable to traverse the buffer with a fixed size as follows:

```
private static final int MAP_SIZE = 5242880; // 5 MB in bytes

try (FileChannel fileChannel = FileChannel.open(
    binaryFile, StandardOpenOption.READ)) {

    int position = 0;
    long length = fileChannel.size();

    while (position < length) {
```

```
        long remaining = length - position;
        int bytestomap = (int) Math.min(MAP_SIZE, remaining);

        MappedByteBuffer mbBuffer = fileChannel.map(
            MapMode.READ_ONLY, position, bytestomap);

        ... // do something with the current buffer

        position += bytestomap;
    }
}
```

Writing binary files

An efficient way of writing binary files is by using `BufferedOutputStream`. For example, writing a `byte[]` to a file can be accomplished as follows:

```
final byte[] buffer...;
Path classFile = Paths.get(
    "build/classes/modern/challenge/Main.class");

try (BufferedOutputStream bos = newBufferedOutputStream(
    Files.newOutputStream(classFile, StandardOpenOption.CREATE,
        StandardOpenOption.WRITE))) {

    bos.write(buffer);
}
```



If you're writing byte by byte, use the `write(int b)` method, and, if you're writing a chunk of data, use the `write(byte[] b, int off, int len)` method.

A very handy method for writing a `byte[]` to a file is `Files.write(Path path, byte[] bytes, OpenOption... options)`. For example, let's write the content of the preceding buffer:

```
Path classFile = Paths.get(
    "build/classes/modern/challenge/Main.class");

Files.write(classFile, buffer,
    StandardOpenOption.CREATE, StandardOpenOption.WRITE);
```

Writing a binary file via `MappedByteBuffer` can be accomplished as follows (this can be useful for writing huge text files):

```
Path classFile = Paths.get(
    "build/classes/modern/challenge/Main.class");
try (FileChannel fileChannel = (FileChannel) Files.newByteChannel(
    classFile, EnumSet.of(StandardOpenOption.CREATE,
        StandardOpenOption.READ, StandardOpenOption.WRITE)) {

    MappedByteBuffer mbBuffer = fileChannel
        .map(FileChannel.MapMode.READ_WRITE, 0, buffer.length);

    if (mbBuffer != null) {
        mbBuffer.put(buffer);
    }
}
```

Finally, if we are writing a certain piece of data (not raw binary data), then we can rely on `DataOutputStream`. This class comes with `writeFoo()` methods for different kinds of data. For example, let's write several floats into a file:

```
Path floatFile = Paths.get("float.bin");

try (DataOutputStream dis = new DataOutputStream(
    new BufferedOutputStream(Files.newOutputStream(floatFile)))) {
    dis.writeFloat(23.56f);
    dis.writeFloat(2.516f);
    dis.writeFloat(56.123f);
}
```

140. Searching in big files

Searching and counting the number of occurrences of a certain string in a file is a common task. Trying to achieve this as fast as possible is a mandatory requirement, especially if the file is big (for example, 200 GB).

Note that the following implementations assume that string *11* occurs only once in *111*, not twice. Moreover, the first three implementations rely on the following helper method from Chapter 1, *Strings, Numbers, and Math*, the *Counting a string in another string* section:

```
private static int countStringInString(String string, String tofind) {
    return string.split(Pattern.quote(tofind), -1).length - 1;
}
```

With that being said, let's take a look at several approaches to this problem.

Solution based on `BufferedReader`

We already know from the previous problems that `BufferedReader` is very efficient for reading text files. Therefore, we can use it to read a big file as well. While reading, for each line obtained via `BufferedReader.readLine()`, we need to count the number of occurrences of the searched string via `countStringInString()`:

```
public static int countOccurrences(Path path, String text, Charset ch)
    throws IOException {

    int count = 0;

    try (BufferedReader br = Files.newBufferedReader(path, ch)) {
        String line;
        while ((line = br.readLine()) != null) {
            count += countStringInString(line, text);
        }
    }

    return count;
}
```

Solution based on `Files.readAllLines()`

If memory (RAM) is not a problem for us, then we can try to read the entire file into memory (via `Files.readAllLines()`) and process it from there. Having the entire file in memory sustains parallel processing. Therefore, if our hardware can be highlighted by parallel processing, then we can try to rely on `parallelStream()`, as follows:

```
public static int countOccurrences(Path path, String text, Charset ch)
    throws IOException {

    return Files.readAllLines(path, ch).parallelStream()
        .mapToInt((p) -> countStringInString(p, text))
        .sum();
}
```



If `parallelStream()` doesn't come with any benefits, then we can simply switch to `stream()`. It is just a matter of benchmarking.

Solution based on Files.lines()

We can try to take advantage of streams via `Files.lines()` as well. This time, we fetch the file as a lazy `Stream<String>`. If we can take advantage of parallel processing (benchmarking reveals better performances), then it is very simple to parallelize `Stream<String>` by calling the `parallel()` method:

```
public static int countOccurrences(Path path, String text, Charset ch)
    throws IOException {

    return Files.lines(path, ch).parallel()
        .mapToInt((p) -> countStringInString(p, text))
        .sum();
}
```

Solution based on Scanner

Starting with JDK 9, the `Scanner` class comes with a method that returns a stream of delimiter-separated tokens, `Stream<String> tokens()`. If we treat the text to search as the delimiter of `Scanner` and we count the entries of the `Stream` returned by `tokens()`, then we obtain the correct result:

```
public static long countOccurrences(
    Path path, String text, Charset ch) throws IOException {

    long count;

    try (Scanner scanner = new Scanner(path, ch)
        .useDelimiter(Pattern.quote(text))) {

        count = scanner.tokens().count() - 1;
    }

    return count;
}
```



The constructors for scanner that support an explicit charset were added in JDK 10.

Solution based on MappedByteBuffer

The last solution that we'll talk about here is based on Java NIO.2, `MappedByteBuffer`, and `FileChannel`. This solution opens a memory-mapped byte buffer (`MappedByteBuffer`) from a `FileChannel` on the given file. We traverse the fetched byte buffer and look for matches with the searched string (this string is converted into a `byte[]` and searching take place byte by byte).

For small files, it is faster to load the entire file into memory. For large/huge files, it is faster to load and process the files in chunks (for example, a chunk of 5 MB). Once we have loaded a chunk, we have to count the number of occurrences of the searched string. We store the result and pass it to the next chunk of data. We repeat this until the entire file has been traversed.

Let's take a look at the core lines of this implementation (take a look at the source code bundled with this book for the complete code):

```
private static final int MAP_SIZE = 5242880; // 5 MB in bytes

public static int countOccurrences(Path path, String text)
    throws IOException {

    final byte[] texttofind = text.getBytes(StandardCharsets.UTF_8);
    int count = 0;

    try (FileChannel fileChannel = FileChannel.open(path,
        StandardOpenOption.READ)) {

        int position = 0;
        long length = fileChannel.size();

        while (position < length) {
            long remaining = length - position;
            int bytestomap = (int) Math.min(MAP_SIZE, remaining);

            MappedByteBuffer mbBuffer = fileChannel.map(
                MapMode.READ_ONLY, position, bytestomap);

            int limit = mbBuffer.limit();
            int lastSpace = -1;
            int firstChar = -1;

            while (mbBuffer.hasRemaining()) {
                // spaghetti code omitted for brevity
                ...
            }
        }
    }
}
```

```
    }  
  
    return count;  
}
```

This solution is extremely fast because the file is read directly from the operating system's memory without having to be loaded into the JVM. The operations take place at the native level, called the operating system level. Note that this implementation works only for the UTF-8 charset, but it can be adapted for other charsets as well.

141. Reading a JSON/CSV file as an object

JSON and CSV files are everywhere these days. Reading (deserialize) JSON/CSV files can be a day-to-day task that typically precedes our business logic. Writing (serialize) JSON/CSV files is also a popular task that typically occurs at the end of the business logic. Between reading and writing such files, an application uses the data as objects.

Read/write a JSON file as an object

Let's start with three text files that represent typical JSON-like mappings:

Raw JSON	Array-like JSON	Map-like JSON
<pre>{ "type": "Gac", "weight": 2000 } { "type": "Hemi", "weight": 1200 }</pre>	<pre>[{ "type": "Gac", "weight": 2000 }, { "type": "Hemi", "weight": 1200 }]</pre>	<pre>{ "A": { "type": "Gac", "weight": 2000 }, "B": { "type": "Hemi", "weight": 1200 } }</pre>
melons_raw.json	melons_array.json	melons_map.json

In `melons_raw.json`, we have a JSON entry per line. Each line is a piece of JSON that's independent of the previous line but has the same schema. In `melons_array.json`, we have a JSON array, and in `melons_map.json`, we have a JSON that fits well in a Java `Map`.

For each of these files, we have a `Path`, as follows:

```
Path pathArray = Paths.get("melons_array.json");
Path pathMap = Paths.get("melons_map.json");
Path pathRaw = Paths.get("melons_raw.json");
```

Now, let's take a look at three dedicated libraries for reading the contents of these files as `Melon` instances:

```
public class Melon {

    private String type;
    private int weight;

    // getters and setters omitted for brevity
}
```

Using JSON-B

Java EE 8 comes with a JAXB-like, declarative JSON binding called JSON-B (JSR-367). JSON-B is consistent with JAXB and other Java EE/SE APIs. Jakarta EE takes Java EE 8 JSON (P and B) to the next level. Its API is exposed via the `javax.json.bind.Jsonb` and `javax.json.bind.JsonbBuilder` classes:

```
Jsonb jsonb = JsonbBuilder.create();
```

For deserialization, we use `Jsonb.fromJson()`, while, for serialization, we use `Jsonb.toJson()`:

- Let's read `melons_array.json` as an Array of `Melon`:

```
Melon[] melonsArray = jsonb.fromJson(Files.newBufferedReader(
    pathArray, StandardCharsets.UTF_8), Melon[].class);
```

- Let's read `melons_array.json` as a List of `Melon`:

```
List<Melon> melonsList
    = jsonb.fromJson(Files.newBufferedReader(
        pathArray, StandardCharsets.UTF_8), ArrayList.class);
```

- Let's read `melons_map.json` as a Map of `Melon`:

```
Map<String, Melon> melonsMap
    = jsonb.fromJson(Files.newBufferedReader(
        pathMap, StandardCharsets.UTF_8), HashMap.class);
```

- Let's read `melons_raw.json` line by line into a `Map`:

```
Map<String, String> stringMap = new HashMap<>();

try (BufferedReader br = Files.newBufferedReader(
    pathRaw, StandardCharsets.UTF_8)) {

    String line;

    while ((line = br.readLine()) != null) {
        stringMap = jsonb.fromJson(line, HashMap.class);
        System.out.println("Current map is: " + stringMap);
    }
}
```

- Let's read `melons_raw.json` line by line into a `Melon`:

```
try (BufferedReader br = Files.newBufferedReader(
    pathRaw, StandardCharsets.UTF_8)) {

    String line;

    while ((line = br.readLine()) != null) {
        Melon melon = jsonb.fromJson(line, Melon.class);
        System.out.println("Current melon is: " + melon);
    }
}
```

- Let's write an object into a JSON file (`melons_output.json`):

```
Path path = Paths.get("melons_output.json");

jsonb.toJson(melonsMap, Files.newBufferedWriter(path,
    StandardCharsets.UTF_8, StandardOpenOption.CREATE,
    StandardOpenOption.WRITE));
```

Using Jackson

Jackson is a popular and fast library dedicated to processing (serializing/deserializing) JSON data. The Jackson API relies on `com.fasterxml.jackson.databind.ObjectMapper`. Let's go over the preceding examples again, but this time using Jackson:

```
ObjectMapper mapper = new ObjectMapper();
```

For deserialization, we use `ObjectMapper.readValue()`, while for serialization, we use `ObjectMapper.writeValue()`:

- Let's read `melons_array.json` as an Array of `Melon`:

```
Melon[] melonsArray
    = mapper.readValue(Files.newBufferedReader(
        pathArray, StandardCharsets.UTF_8), Melon[].class);
```

- Let's read `melons_array.json` as a List of `Melon`:

```
List<Melon> melonsList
    = mapper.readValue(Files.newBufferedReader(
        pathArray, StandardCharsets.UTF_8), ArrayList.class);
```

- Let's read `melons_map.json` as a Map of `Melon`:

```
Map<String, Melon> melonsMap
    = mapper.readValue(Files.newBufferedReader(
        pathMap, StandardCharsets.UTF_8), HashMap.class);
```

- Let's read `melons_raw.json` line by line into a Map:

```
Map<String, String> stringMap = new HashMap<>();

try (BufferedReader br = Files.newBufferedReader(
    pathRaw, StandardCharsets.UTF_8)) {

    String line;

    while ((line = br.readLine()) != null) {
        stringMap = mapper.readValue(line, HashMap.class);
        System.out.println("Current map is: " + stringMap);
    }
}
```

- Let's read `melons_raw.json` line by line into a `Melon`:

```
try (BufferedReader br = Files.newBufferedReader(
    pathRaw, StandardCharsets.UTF_8)) {

    String line;

    while ((line = br.readLine()) != null) {
        Melon melon = mapper.readValue(line, Melon.class);
        System.out.println("Current melon is: " + melon);
    }
}
```

- Let's write an object into a JSON file (`melons_output.json`):

```
Path path = Paths.get("melons_output.json");

mapper.writeValue(Files.newBufferedWriter(path,
    StandardCharsets.UTF_8, StandardOpenOption.CREATE,
    StandardOpenOption.WRITE), melonsMap);
```

Using Gson

Gson is another fast library dedicated to processing (serializing/deserializing) JSON data. In a Maven project, it can be added as a dependency in `pom.xml`. Its API relies on a class name, `com.google.gson.Gson`. The code that's bundled with this book provides a suite of examples for it.

Reading a CSV file as an object

The simplest CSV file looks like the file in the following illustration (lines of data separated by commas):



```
melon.csv
CSV
Gaac,2000
Heml,1500
Cantaloupe,800
Golden Prize,2300
Crenshaw,3000
```

A simple and efficient solution to deserializing this kind of CSV file relies on the `BufferedReader` and `String.split()` methods. We can read each line from the file via `BufferedReader.readLine()` and split it with a comma delimiter via `String.split()`. The result (each line of content) can be stored in a `List<String>`. The final result will be a `List<List<String>>`, as follows:

```
public static List<List<String>> readAsObject(
    Path path, Charset cs, String delimiter) throws IOException {

    List<List<String>> content = new ArrayList<>();

    try (BufferedReader br = Files.newBufferedReader(path, cs)) {

        String line;

        while ((line = br.readLine()) != null) {
            String[] values = line.split(delimiter);
```

```
        content.add(Arrays.asList(values));
    }
}

return content;
}
```

If the CSV data has POJOs correspondents (for example, our CSV is the result of serializing a bunch of `Melon` instances), then it can be deserialized, as shown in the following example:

```
public static List<Melon> readAsMelon(
    Path path, Charset cs, String delimiter) throws IOException {

    List<Melon> content = new ArrayList<>();

    try (BufferedReader br = Files.newBufferedReader(path, cs)) {

        String line;

        while ((line = br.readLine()) != null) {
            String[] values = line.split(Pattern.quote(delimiter));
            content.add(new Melon(values[0], Integer.valueOf(values[1])));
        }

    }

    return content;
}
```



For complex CSV files, it is advisable to rely on dedicated libraries (for example, `OpenCSV`, `Apache Commons CSV`, `Super CSV`, and so on).

142. Working with temporary files/folders

The Java NIO.2 API provides support for working with temporary folders/files. For example, we can easily locate the default location for temporary folders/files as follows:

```
String defaultBaseDir = System.getProperty("java.io.tmpdir");
```

Commonly, in Windows, the default temporary folder is `C:\Temp`, `%Windows%\Temp`, or a temporary directory per user in `Local Settings\Temp` (this location is usually controlled via the `TEMP` environment variable). In Linux/Unix, the global temporary directories are `/tmp` and `/var/tmp`. The preceding line of code will return the default location, depending on the operating system.

In the next section, we'll learn how to create a temporary folder/file.

Creating a temporary folder/file

Creating a temporary folder can be accomplished using `Path createTempDirectory(Path dir, String prefix, FileAttribute<?>... attrs)`. This is a static method in the `Files` class that can be used as follows:

- Let's create a temporary folder in the OS's default location with no prefix:

```
// C:\Users\Anghel\AppData\Local\Temp\8083202661590940905
Path tmpNoPrefix = Files.createTempDirectory(null);
```

- Let's create a temporary folder in the OS's default location with a custom prefix:

```
// C:\Users\Anghel\AppData\Local\Temp\logs_5825861687219258744
String customDirPrefix = "logs_";
Path tmpCustomPrefix
    = Files.createTempDirectory(customDirPrefix);
```

- Let's create a temporary folder in a custom location with a custom prefix:

```
// D:\tmp\logs_10153083118282372419
Path customBaseDir
    = FileSystems.getDefault().getPath("D:/tmp");
String customDirPrefix = "logs_";
Path tmpCustomLocationAndPrefix
    = Files.createTempDirectory(customBaseDir, customDirPrefix);
```

Creating a temporary file can be accomplished via `Path createTempFile(Path dir, String prefix, String suffix, FileAttribute<?>... attrs)`. This is a static method in the `Files` class that can be used as follows:

- Let's create a temporary file in the OS's default location with no prefix and suffix:

```
// C:\Users\Anghel\AppData\Local\Temp\16106384687161465188.tmp
Path tmpNoPrefixSuffix = Files.createTempFile(null, null);
```

- Let's create a temporary file in the OS's default location with a custom prefix and suffix:

```
// C:\Users\Anghel\AppData\Local\Temp\log_402507375350226.txt
String customFilePrefix = "log_";
String customFileSuffix = ".txt";
Path tmpCustomPrefixAndSuffix
    = Files.createTempFile(customFilePrefix, customFileSuffix);
```

- Let's create a temporary file in a custom location with a custom prefix and suffix:

```
// D:\tmp\log_13299365648984256372.txt
Path customBaseDir
    = FileSystems.getDefault().getPath("D:/tmp");
String customFilePrefix = "log_";
String customFileSuffix = ".txt";
Path tmpCustomLocationPrefixSuffix = Files.createTempFile(
    customBaseDir, customFilePrefix, customFileSuffix);
```

In the following sections, we'll take a look at the different ways we can delete a temporary folder/file.

Deleting a temporary folder/file via shutdown-hook

Deleting a temporary folder/file is a task that can be accomplished by the operating system or specialized tools. However, sometimes, we need to control this programmatically and delete a folder/file based on different design considerations.

A solution to this problem relies on the *shutdown-hook* mechanism, which can be implemented via the `Runtime.getRuntime().addShutdownHook()` method. This mechanism is useful whenever we need to complete certain tasks (for example, cleanup tasks) right before the JVM shuts down. It is implemented as a Java thread whose `run()` method is invoked when the *shutdown-hook* is executed by JVM at shut down. This is shown in the following code:

```
Path customBaseDir = FileSystems.getDefault().getPath("D:/tmp");
String customDirPrefix = "logs_";
String customFilePrefix = "log_";
String customFileSuffix = ".txt";

try {
    Path tmpDir = Files.createTempDirectory(
        customBaseDir, customDirPrefix);
    Path tmpFile1 = Files.createTempFile(
```

```
    tmpDir, customFilePrefix, customFileSuffix);
Path tmpFile2 = Files.createTempFile(
    tmpDir, customFilePrefix, customFileSuffix);

Runtime.getRuntime().addShutdownHook(new Thread() {
    @Override
    public void run() {
        try (DirectoryStream<Path> ds
            = Files.newDirectoryStream(tmpDir)) {
            for (Path file: ds) {
                Files.delete(file);
            }

            Files.delete(tmpDir);
        } catch (IOException e) {
            ...
        }
    }
});

//simulate some operations with temp file until delete it
Thread.sleep(10000);
} catch (IOException | InterruptedException e) {
    ...
}
```



A *shutdown-hook* will not be executed in the case of abnormal/forced terminations (for example, JVM crashes, Terminal operations are triggered, and so on). It runs when all the threads finish or when `System.exit(0)` is called. It is advisable to run it fast since they can be forcibly stopped before completion if something goes wrong (for example, the OS shuts down). Programmatically, a *shutdown-hook* can only be stopped by `Runtime.halt()`.

Deleting a temporary folder/file via `deleteOnExit()`

Another solution for deleting a temporary folder/file relies on the `File.deleteOnExit()` method. By calling this method, we can register for the deletion of a folder/file. The deletion action happens when JVM shuts down:

```
Path customBaseDir = FileSystems.getDefault().getPath("D:/tmp");
String customDirPrefix = "logs_";
String customFilePrefix = "log_";
String customFileSuffix = ".txt";
```

```
try {
    Path tmpDir = Files.createTempDirectory(
        customBaseDir, customDirPrefix);
    System.out.println("Created temp folder as: " + tmpDir);
    Path tmpFile1 = Files.createTempFile(
        tmpDir, customFilePrefix, customFileSuffix);
    Path tmpFile2 = Files.createTempFile(
        tmpDir, customFilePrefix, customFileSuffix);

    try (DirectoryStream<Path> ds = Files.newDirectoryStream(tmpDir)) {
        tmpDir.toFile().deleteOnExit();

        for (Path file: ds) {
            file.toFile().deleteOnExit();
        }
    } catch (IOException e) {
        ...
    }

    // simulate some operations with temp file until delete it
    Thread.sleep(10000);
} catch (IOException | InterruptedException e) {
    ...
}
```



It is advisable to only rely on this method (`deleteOnExit()`) when the application manages a small number of temporary folders/files. This method may consume a lot of memory (it consumes memory for each temporary resource that's registered for deletion) and this memory may not be released until JVM terminates. Pay attention, since this method needs to be called in order to register each temporary resource, and the deletion takes place in reverse order of registration (for example, we must register a temporary folder before registering its content).

Deleting a temporary file via `DELETE_ON_CLOSE`

Another solution when it comes to deleting a temporary file relies on `StandardOpenOption.DELETE_ON_CLOSE` (this deletes the file when the stream is closed). For example, the following piece of code creates a temporary file via the `createTempFile()` method and opens a buffered writer stream for it with `DELETE_ON_CLOSE` explicitly specified:

```
Path customBaseDir = FileSystems.getDefault().getPath("D:/tmp");
String customFilePrefix = "log_";
```

```
String customFileSuffix = ".txt";
Path tmpFile = null;

try {
    tmpFile = Files.createTempFile(
        customBaseDir, customFilePrefix, customFileSuffix);
} catch (IOException e) {
    ...
}

try (BufferedWriter bw = Files.newBufferedWriter(tmpFile,
    StandardCharsets.UTF_8, StandardOpenOption.DELETE_ON_CLOSE)) {

    //simulate some operations with temp file until delete it
    Thread.sleep(10000);
} catch (IOException | InterruptedException e) {
    ...
}
```



This solution can be adopted for any file. It is not specific to temporary resources.

143. Filtering files

Filtering files from a `Path` is a very common task. For example, we may only want the files of a specific type, with a certain name pattern, modified today, and so on.

Filtering via `Files.newDirectoryStream()`

Without any kind of filter, we can easily loop a folder's content (one level deep) via the `Files.newDirectoryStream(Path dir)` method. This method returns a `DirectoryStream<Path>`, which is an object that we can use to iterate over the entries in a directory:

```
Path path = Paths.get("D:/learning/books/spring");

try (DirectoryStream<Path> ds = Files.newDirectoryStream(path)) {

    for (Path file: ds) {
        System.out.println(file.getFileName());
    }
}
```

If we want to enrich this snippet of code with a filter, then we have at least two solutions. One solution relies on another flavor of the `newDirectoryStream()` method, `newDirectoryStream(Path dir, String glob)`. Besides `Path`, this method receives a filter by using the *glob* syntax. For example, we can filter the `D:/learning/books/spring` folder for files that are of the PNG, JPG, and BMP types:

```
try (DirectoryStream<Path> ds =
    Files.newDirectoryStream(path, "*. {png,jpg,bmp}")) {

    for (Path file: ds) {
        System.out.println(file.getFileName());
    }
}
```

When *glob* syntax cannot help us anymore, it's time to use another flavor of `newDirectoryStream()` that gets a `Filter`, that is, `newDirectoryStream(Path dir, DirectoryStream.Filter<? super Path> filter)`. First, let's define a filter for files larger than 10 MB:

```
DirectoryStream.Filter<Path> sizeFilter
    = new DirectoryStream.Filter<>() {

    @Override
    public boolean accept(Path path) throws IOException {
        return (Files.size(path) > 1024 * 1024 * 10);
    }
};
```

We can also do this in functional-style:

```
DirectoryStream.Filter<Path> sizeFilter
    = p -> (Files.size(p) > 1024 * 1024 * 10);
```

Now, we can apply this filter like so:

```
try (DirectoryStream<Path> ds =
    Files.newDirectoryStream(path, sizeFilter)) {

    for (Path file: ds) {
        System.out.println(file.getFileName() + " " +
            Files.readAttributes(file, BasicFileAttributes.class).size()
            + " bytes");
    }
}
```

Let's check out a few more filters that we can use with this technique:

- The following is a user-defined filter for folders:

```
DirectoryStream.Filter<Path> folderFilter
    = new DirectoryStream.Filter<>() {

    @Override
    public boolean accept(Path path) throws IOException {
        return (Files.isDirectory(path, NOFOLLOW_LINKS));
    }
};
```

- The following is a user-defined filter for files that have been modified today:

```
DirectoryStream.Filter<Path> todayFilter
    = new DirectoryStream.Filter<>() {

    @Override
    public boolean accept(Path path) throws IOException {
        FileTime lastModified = Files.readAttributes(path,
            BasicFileAttributes.class).lastModifiedTime();

        LocalDate lastModifiedDate = lastModified.toInstant()
            .atOffset(ZoneOffset.UTC).toLocalDate();
        LocalDate todayDate = Instant.now()
            .atOffset(ZoneOffset.UTC).toLocalDate();

        return lastModifiedDate.equals(todayDate);
    }
};
```

- The following is a user-defined filter for hidden files/folders:

```
DirectoryStream.Filter<Path> hiddenFilter
    = new DirectoryStream.Filter<>() {

    @Override
    public boolean accept(Path path) throws IOException {
        return (Files.isHidden(path));
    }
};
```

In the following sections, we'll take a look at the different ways we can filter a file.

Filtering via FilenameFilter

The `FilenameFilter` functional interface can be used to filter files from a folder as well. First, we need to define a filter (for example, the following is a filter for files of the PDF type):

```
String[] files = path.toFile().list(new FilenameFilter() {  
  
    @Override  
    public boolean accept(File folder, String fileName) {  
        return fileName.endsWith(".pdf");  
    }  
});
```

We can do the same in functional-style:

```
FilenameFilter filter = (File folder, String fileName)  
    -> fileName.endsWith(".pdf");
```

Let's make this more concise:

```
FilenameFilter filter = (f, n) -> n.endsWith(".pdf");
```

In order to use this filter, we need to pass it to the overloaded `File.list(FilenameFilter filter)` or `File.listFiles(FilenameFilter filter)` method:

```
String[] files = path.toFile().list(filter);
```

The files array will only contain the names of the PDF files.



For fetching the result as a `File[]`, we should call `listFiles()` instead of `list()`.

Filtering via FileFilter

`FileFilter` is another functional interface that can be used to filter files and folders. For example, let's filter only folders:

```
File[] folders = path.toFile().listFiles(new FileFilter() {  
  
    @Override  
    public boolean accept(File file) {  
        return file.isDirectory();  
    }  
});
```

```
    }
  });
```

We can do the same in functional-style:

```
File[] folders = path.toFile().listFiles((File file)
    -> file.isDirectory());
```

Let's make this more concise:

```
File[] folders = path.toFile().listFiles(f -> f.isDirectory());
```

Finally, we can do this via member reference:

```
File[] folders = path.toFile().listFiles(File::isDirectory);
```

144. Discovering mismatches between two files

The solution to this problem is comparing the content of two files (a byte by byte comparison) until the first mismatch is found or the EOF is reached.

Let's consider the following four text files:

This is a file for testing mismatches between two files!	This is a file for testing mismatches between two files!	This is a file for testing mismatches between two files!	This is a file for testing mismatches between two files.
file1.txt	file2.txt	file3.txt	file4.txt

Only the first two files (`file1.txt` and `file2.txt`) are identical. Any other comparison should reveal the presence of at least one mismatch.

One solution is to use `MappedByteBuffer`. This solution is super-fast and easy to implement. We just open two `FileChannels` (one for each file) and perform a byte by byte comparison until we find the first mismatch or EOF. If the files don't have the same length in terms of bytes, then we assume that the files are not the same and return immediately:

```
private static final int MAP_SIZE = 5242880; // 5 MB in bytes

public static boolean haveMismatches(Path p1, Path p2)
    throws IOException {
```



```
try (FileChannel channel1 = (FileChannel.open(p1,
    EnumSet.of(StandardOpenOption.READ)))) {

    try (FileChannel channel2 = (FileChannel.open(p2,
        EnumSet.of(StandardOpenOption.READ)))) {

        long length1 = channel1.size();
        long length2 = channel2.size();

        if (length1 != length2) {
            return true;
        }

        int position = 0;
        while (position < length1) {
            long remaining = length1 - position;
            int bytestomap = (int) Math.min(MAP_SIZE, remaining);

            MappedByteBuffer mbBuffer1 = channel1.map(
                MapMode.READ_ONLY, position, bytestomap);
            MappedByteBuffer mbBuffer2 = channel2.map(
                MapMode.READ_ONLY, position, bytestomap);

            while (mbBuffer1.hasRemaining()) {
                if (mbBuffer1.get() != mbBuffer2.get()) {
                    return true;
                }
            }

            position += bytestomap;
        }
    }
}

return false;
}
```



JDK 13 has prepared the release of non-volatile
MappedByteBuffers. Stay tuned!

Starting with JDK 12, the `Files` class has been enriched with a new method dedicated to pointing mismatches between two files. This method has the following signature:

```
public static long mismatch(Path path, Path path2) throws IOException
```

This method finds and returns the position of the first mismatched byte in the content of two files. If there is no mismatch, then it returns `-1`:

```
long mismatches12 = Files.mismatch(file1, file2); // -1
long mismatches13 = Files.mismatch(file1, file3); // 51
long mismatches14 = Files.mismatch(file1, file4); // 60
```

145. Circular byte buffer

The Java NIO.2 API comes with an implementation of a byte buffer called `java.nio.ByteBuffer`. Basically, this is an array of bytes (`byte[]`) that's wrapped with a suite of methods dedicated to manipulating this array (for example, `get()`, `put()`, and so on). A circular buffer (cyclic buffer, ring buffer, or circular queue) is a fixed-size buffer that's connected end-to-end. The following diagram shows us what a circular queue looks like:

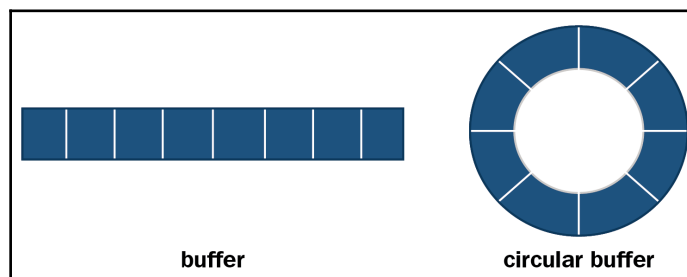

A circular buffer relies on a pre-allocated array (pre-allocated capacity), but some implementations may require a resizing capability as well. The elements are written/added to the back (*tail*) and removed/read from the front (*head*); this can be seen in the following diagram:

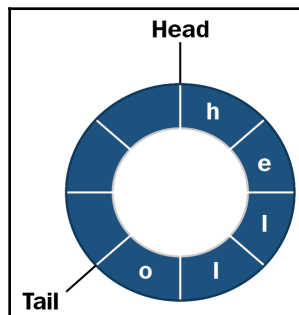

For the main operations, that is, read (get) and write (put), a circular buffer maintains a pointer (a read pointer and a write pointer). Both pointers are wrapped around the buffer capacity. We can find out how many elements are available to be read and how many free slots can be written whenever we like. This operation takes place in $O(1)$.

A circular byte buffer is a circular buffer of bytes; it can be of chars or some other type. This is exactly what we want to implement here. We can start by writing a stub of our implementation, as follows:

```
public class CircularByteBuffer {

    private int capacity;
    private byte[] buffer;
    private int readPointer;
    private int writePointer;
    private int available;

    CircularByteBuffer(int capacity) {
        this.capacity = capacity;
        buffer = new byte[capacity];
    }

    public synchronized int available() {
        return available;
    }

    public synchronized int capacity() {
        return capacity;
    }

    public synchronized int slots() {
        return capacity - available;
    }

    public synchronized void clear() {
        readPointer = 0;
        writePointer = 0;
        available = 0;
    }
    ...
}
```

Now, let's focus on putting (writing) new bytes and reading (getting) existing bytes. For example, a circular byte buffer that has a capacity of 8 can be represented like so:

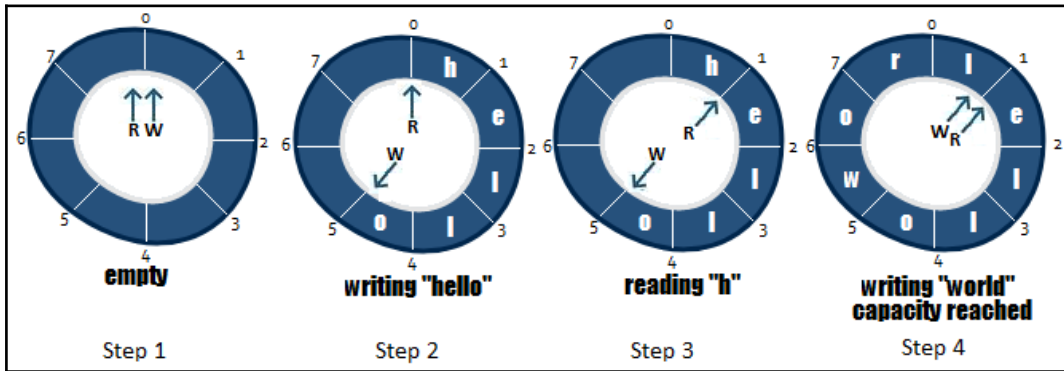

Let's take a look at what's happening at each step:

1. The circular byte buffer is empty and both pointers point to slot 0 (the first slot).
2. We put the 5 bytes corresponding to **hello** in the buffer. `readPointer` remains in the same position, while `writePointer` points to slot 5.
3. We get the bytes corresponding with the **h**, so `readPointer` moves to slot 1.
4. Finally, we attempt to put the bytes of **world** in the buffer. This word is made up of 5 bytes, but we have only four free slots until we reach the buffer capacity. This means we can only write the bytes that correspond with **world**.

Now, let's take a look at the scenario in the following diagram:

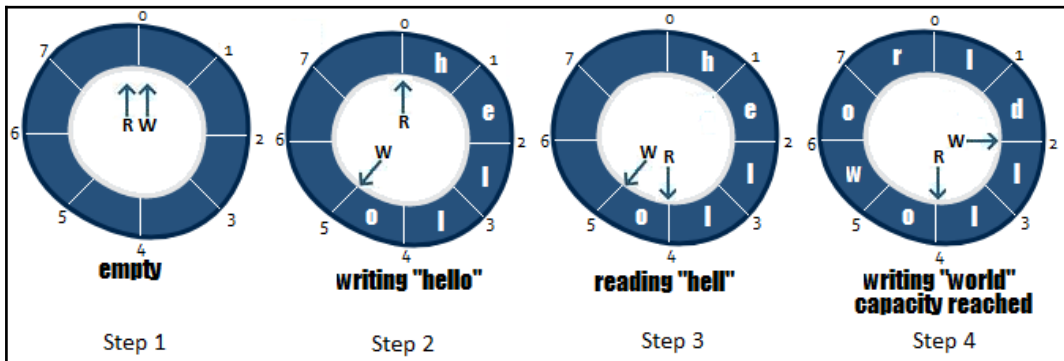

From left to right, the steps are as follows::

1. The first two steps are the same as the ones from the previous scenario.
2. We get the bytes for **hell**. This will move `readPointer` to position 4.
3. Finally, we put the bytes of **world** in the buffer. This time, the word fits in the buffer and `writePointer` moves to slot 2.

Based on this flow, we can easily implement a method that puts one byte in the buffer and another that gets one byte from the buffer, as follows:

```
public synchronized boolean put(int value) {
    if (available == capacity) {
        return false;
    }

    buffer[writePointer] = (byte) value;
    writePointer = (writePointer + 1) % capacity;
    available++;

    return true;
}

public synchronized int get() {
    if (available == 0) {
        return -1;
    }

    byte value = buffer[readPointer];
    readPointer = (readPointer + 1) % capacity;
    available--;

    return value;
}
```

If we check the Java NIO.2 `ByteBuffer` API, we'll notice that it exposes several flavors of the `get()` and `put()` methods. For example, we should be able to pass a `byte[]` to the `get()` method and this method should copy a range of elements from the buffer into this `byte[]`. The elements are read from the buffer, starting with the current `readPointer`, and are written in the given `byte[]`, starting from the specified `offset`.

The following diagram exposes a case where `writePointer` is greater than `readPointer`:

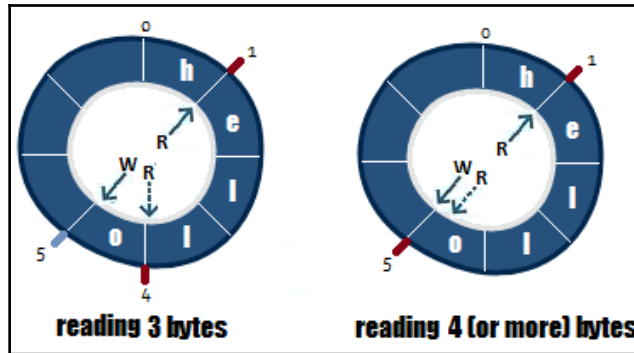

On the left-hand side, we are reading 3 bytes. This moves `readPointer` from its initial slot, 1, to slot 4. On the right-hand side, we are reading 4 (or more than 4) bytes. Since there are only 4 bytes available, `readPointer` is moved from its initial slot to the same slot as `writePointer` (slot 5).

Now, let's analyze a case where `writePointer` is less than `readPointer`:

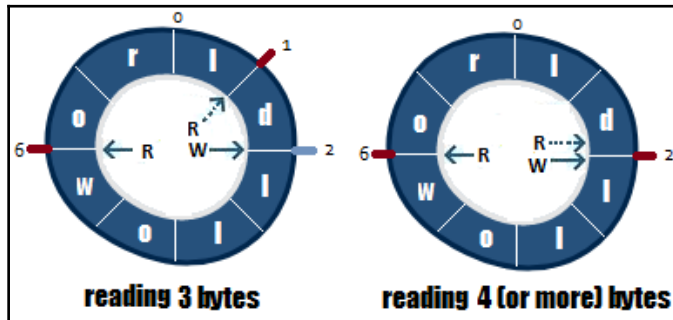

On the left-hand side, we are reading 3 bytes. This moves `readPointer` from its initial slot, 6, to slot 1. On the right-hand side, we are reading 4 (or more than 4) bytes. This moves `readPointer` from its initial slot, 6, to slot 2 (the same slot as `writePointer`).

Now that we have these two use cases in mind, we can write a `get()` method in order to copy a range of bytes from the buffer into the given `byte[]`, as follows (this method attempts to read `len` bytes from the buffer and write them into the given `byte[]`, starting from the given `offset`):

```
public synchronized int get(byte[] dest, int offset, int len) {  
  
    if (available == 0) {  
        return 0;  
    }  
  
    int maxPointer = capacity;  
  
    if (readPointer < writePointer) {  
        maxPointer = writePointer;  
    }  
  
    int countBytes = Math.min(maxPointer - readPointer, len);  
    System.arraycopy(buffer, readPointer, dest, offset, countBytes);  
    readPointer = readPointer + countBytes;  
  
    if (readPointer == capacity) {  
        int remainingBytes = Math.min(len - countBytes, writePointer);  
  
        if (remainingBytes > 0) {  
            System.arraycopy(buffer, 0, dest,  
                offset + countBytes, remainingBytes);  
            readPointer = remainingBytes;  
            countBytes = countBytes + remainingBytes;  
        } else {  
            readPointer = 0;  
        }  
    }  
  
    available = available - countBytes;  
  
    return countBytes;  
}
```

Now, let's focus on putting the given `byte[]` into the buffer. The elements are read from the given `byte[]` starting from the specified `offset` and are written into the buffer starting from the current `writePointer`. The following diagram exposes a case where `writePointer` is greater than `readPointer`:

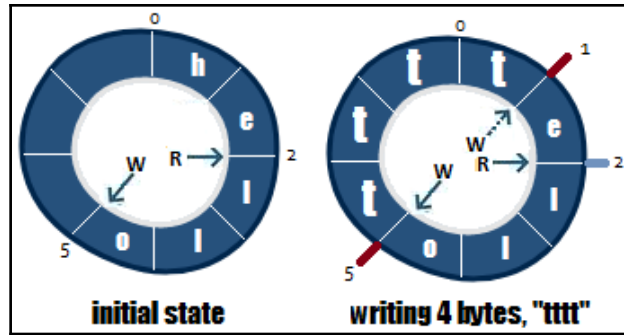

On the left-hand side, we have the initial state of the buffer. So, `readPointer` points to slot 2, and `writePointer` points to slot 5. After writing 4 bytes (on the right-hand side), we can see that `readPointer` was not affected and that `writePointer` points to slot 1.

The other use case assumes that `readPointer` is greater than `writePointer`:

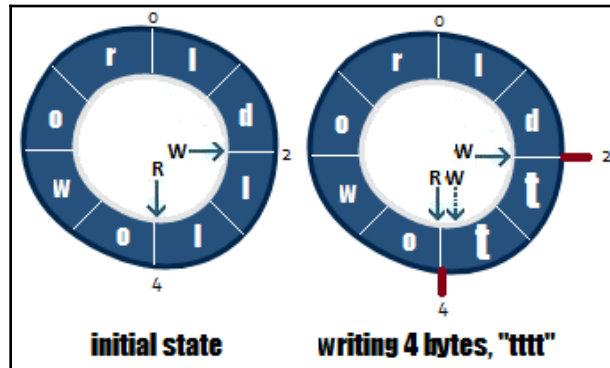

On the left-hand side, we have the initial state of the buffer. So, `readPointer` points to slot 4, and `writePointer` points to slot 2. After writing 4 bytes (on the right-hand side), we can see that `readPointer` was not affected and that `writePointer` points to slot 4. Notice that only two bytes were successfully written. This has happened because we reached the maximum capacity of the buffer before writing all 4 bytes.

Now that we have these two use cases in mind, we can write a `put()` method in order to copy a range of bytes from the given `byte[]` into the buffer, as follows (the method attempts to read `len` bytes from the given `byte[]` starting from the given offset and attempts to write them into the buffer starting from the current `writePointer`):

```
public synchronized int put(byte[] source, int offset, int len) {  
    if (available == capacity) {  
        return 0;  
    }  
  
    int maxPointer = capacity;  
  
    if (writePointer < readPointer) {  
        maxPointer = readPointer;  
    }  
  
    int countBytes = Math.min(maxPointer - writePointer, len);  
    System.arraycopy(source, offset, buffer, writePointer, countBytes);  
    writePointer = writePointer + countBytes;  
  
    if (writePointer == capacity) {  
        int remainingBytes = Math.min(len - countBytes, readPointer);  
  
        if (remainingBytes > 0) {  
            System.arraycopy(source, offset + countBytes,  
                buffer, 0, remainingBytes);  
            writePointer = remainingBytes;  
            countBytes = countBytes + remainingBytes;  
        } else {  
            writePointer = 0;  
        }  
    }  
  
    available = available + countBytes;  
  
    return countBytes;  
}
```

As we mentioned earlier, sometimes, we need to resize the buffer. For example, we may want to double its size by simply calling the `resize()` method. Basically, this means copying all the available bytes (elements) into a new buffer with double capacity:

```
public synchronized void resize() {  
  
    byte[] newBuffer = new byte[capacity * 2];  
  
    if (readPointer < writePointer) {  
        System.arraycopy(buffer, readPointer, newBuffer, 0, available);  
    } else {  
        int bytesToCopy = capacity - readPointer;  
        System.arraycopy(buffer, readPointer, newBuffer, 0, bytesToCopy);  
        System.arraycopy(buffer, 0, newBuffer, bytesToCopy, writePointer);  
    }  
  
    buffer = newBuffer;  
    capacity = buffer.length;  
    readPointer = 0;  
    writePointer = available;  
}
```

Check the source code bundled with this book to see how it works in full.

146. Tokenizing files

The content in a file is not always received in a way that means it can be processed immediately and will require some additional steps so that it can be prepared for processing. Typically, we need to tokenize the file and extract information from different data structures (arrays, lists, maps, and so on).

For example, let's consider a file, `clothes.txt`:

```
Path path = Paths.get("clothes.txt");
```

Its content is as follows:

```
Top|white\10/XXL&Swimsuit|black\5/L  
Coat|red\11/M&Golden Jacket|yellow\12/XLDenim|Blue\22/M
```

This file contains some clothing articles and their details separated by the `&` character. A single article is represented as follows:

```
article name | color \ no. available items / size
```

Here, we have several delimiters (&#x27;, |, \, /) and a very specific format.

Now, let's take a look at several solutions for extracting and tokenizing the information from this file as a `List`. We'll collect this information in a utility class, `FileTokenizer`.

One solution for fetching the articles in a `List` relies on the `String.split()` method. Basically, we have to read the file line by line and apply `String.split()` to each line. The result of tokenizing each line is collected in a `List` via the `List.addAll()` method:

```
public static List<String> get(Path path,
    Charset cs, String delimiter) throws IOException {

    String delimiterStr = Pattern.quote(delimiter);
    List<String> content = new ArrayList<>();

    try (BufferedReader br = Files.newBufferedReader(path, cs)) {

        String line;
        while ((line = br.readLine()) != null) {
            String[] values = line.split(delimiterStr);
            content.addAll(Arrays.asList(values));
        }
    }

    return content;
}
```

Calling this method with the `&#x27;` delimiter will produce the following output:

```
[Top|white\10/XXL, Swimsuit|black\5/L, Coat|red\11/M, Golden
Jacket|yellow\12/XL, Denim|Blue\22/M]
```

Another flavor of the preceding solution can rely on `Collectors.toList()` instead of `Arrays.asList()`:

```
public static List<String> get(Path path,
    Charset cs, String delimiter) throws IOException {

    String delimiterStr = Pattern.quote(delimiter);
    List<String> content = new ArrayList<>();

    try (BufferedReader br = Files.newBufferedReader(path, cs)) {

        String line;
        while ((line = br.readLine()) != null) {
```

```
        content.addAll(Stream.of(line.split(delimiterStr))
            .collect(Collectors.toList()));
    }
}

return content;
}
```

Alternatively, we can process the content in a lazy manner via `Files.lines()`:

```
public static List<String> get(Path path,
    Charset cs, String delimiter) throws IOException {

    try (Stream<String> lines = Files.lines(path, cs)) {

        return lines.map(l -> l.split(Pattern.quote(delimiter)))
            .flatMap(Arrays::stream)
            .collect(Collectors.toList());
    }
}
```

For relatively small files, we can load it in memory and process it accordingly:

```
Files.readAllLines(path, cs).stream()
    .map(l -> l.split(Pattern.quote(delimiter)))
    .flatMap(Arrays::stream)
    .collect(Collectors.toList());
```

Another solution can rely on JDK 8's `Pattern.splitAsStream()` method. This method creates a stream from the given input sequence. For the sake of variation, this time, let's collect the resulted list via `Collectors.joining(";")`:

```
public static List<String> get(Path path,
    Charset cs, String delimiter) throws IOException {

    Pattern pattern = Pattern.compile(Pattern.quote(delimiter));
    List<String> content = new ArrayList<>();

    try (BufferedReader br = Files.newBufferedReader(path, cs)) {

        String line;
        while ((line = br.readLine()) != null) {
            content.add(pattern.splitAsStream(line)
                .collect(Collectors.joining(";")));
        }
    }
    return content;
}
```

Let's call this method with the `&` delimiter:

```
List<String> tokens = FileTokenizer.get(
    path, StandardCharsets.UTF_8, "&");
```

The result is as follows:

```
[Top|white\10/XXL;Swimsuit|black\5/L, Coat|red\11/M;Golden
Jacket|yellow\12/XL, Denim|Blue\22/M]
```

So far, the presented solutions obtain a list of articles by applying a single delimiter. But sometimes, we need to apply more delimiters. For example, let's assume that we want to obtain the following output (list):

```
[Top, white, 10, XXL, Swimsuit, black, 5, L, Coat, red, 11, M, Golden
Jacket, yellow, 12, XL, Denim, Blue, 22, M]
```

In order to obtain this list, we have to apply several delimiters (`&`, `|`, `\`, and `/`). This can be accomplished by using `String.split()` and passing a regular expression based on the logical OR operator (`x|y`) to it:

```
public static List<String> getWithMultipleDelimiters(
    Path path, Charset cs, String...delimiters) throws IOException {

    String[] escapedDelimiters = new String[delimiters.length];
    Arrays.setAll(escapedDelimiters, t -> Pattern.quote(delimiters[t]));
    String delimiterStr = String.join("|", escapedDelimiters);

    List<String> content = new ArrayList<>();

    try (BufferedReader br = Files.newBufferedReader(path, cs)) {

        String line;
        while ((line = br.readLine()) != null) {
            String[] values = line.split(delimiterStr);
            content.addAll(Arrays.asList(values));
        }

    }

    return content;
}
```

Let's call this method with our delimiters (`&`, `|`, `\`, and `/`) to obtain the required result:

```
List<String> tokens = FileTokenizer.getWithMultipleDelimiters(
    path, StandardCharsets.UTF_8,
    new String[] {"&", "|", "\\", "/"});
```

Ok; so far, so good! All of these solutions are based on `String.split()` and `Pattern.splitAsStream()`. Another set of solutions can rely on the `StringTokenizer` class (it doesn't excel at performance, so use it carefully). This class can apply a delimiter (or more than one) to the given string and expose the two main methods for controlling it, that is, `hasMoreElements()` and `nextToken()`:

```
public static List<String> get(Path path,
    Charset cs, String delimiter) throws IOException {

    StringTokenizer st;
    List<String> content = new ArrayList<>();

    try (BufferedReader br = Files.newBufferedReader(path, cs)) {

        String line;
        while ((line = br.readLine()) != null) {
            st = new StringTokenizer(line, delimiter);
            while (st.hasMoreElements()) {
                content.add(st.nextToken());
            }
        }
    }

    return content;
}
```

It can be used in conjunction with `Collectors` as well:

```
public static List<String> get(Path path,
    Charset cs, String delimiter) throws IOException {

    List<String> content = new ArrayList<>();

    try (BufferedReader br = Files.newBufferedReader(path, cs)) {

        String line;
        while ((line = br.readLine()) != null) {
            content.addAll(Collections.list(
                new StringTokenizer(line, delimiter)).stream()
                .map(t -> (String) t)
                .collect(Collectors.toList()));
        }
    }

    return content;
}
```

Multiple delimiters can be used if we separate them using `//`:

```
public static List<String> getWithMultipleDelimiters(
    Path path, Charset cs, String...delimiters) throws IOException {

    String delimiterStr = String.join("//", delimiters);
    StringTokenizer st;
    List<String> content = new ArrayList<>();

    try (BufferedReader br = Files.newBufferedReader(path, cs)) {

        String line;
        while ((line = br.readLine()) != null) {
            st = new StringTokenizer(line, delimiterStr);
            while (st.hasMoreElements()) {
                content.add(st.nextToken());
            }
        }
    }

    return content;
}
```



For better performance and regular expression support (that is, high flexibility) it is advisable to rely on `String.split()` instead of `StringTokenizer`. From the same category, consider the *Working with Scanner* section as well.

147. Writing formatted output directly to a file

Let's suppose that we have 10 numbers (integers and doubles) and we want them to be nicely formatted (have an indentation, alignment, and a number of decimals that sustain readability and usefulness) in a file.

In our first attempt, we wrote them to the file like so (no formatting was applied):

```
Path path = Paths.get("noformatter.txt");

try (BufferedWriter bw = Files.newBufferedWriter(path,
    StandardCharsets.UTF_8, StandardOpenOption.CREATE,
    StandardOpenOption.WRITE)) {

    for (int i = 0; i < 10; i++) {
        bw.write("| " + intValues[i] + " | " + doubleValues[i] + " | ");
        bw.newLine();
    }
}
```

```

    }
}

```

The output of the preceding code is similar to what's shown on the left-hand side of the following diagram:

Obtained		Wanted	
78910	0.9276730641526881	78910	0.928
83222	0.28423903775300785	83222	0.284
5593	0.866538798997145	5593	0.867
57329	0.9145723363689985	57329	0.915
61443	0.41527451214386724	61443	0.415
9043	0.8442927124583571	9043	0.844
474	0.9159122616950742	474	0.916
45763	0.04448867226365116	45763	0.044
26671	0.4648636732351614	26671	0.465
24096	0.12870733626570974	24096	0.129

However, we want to obtain the result that's shown on the right-hand side of the preceding diagram. In order to solve this problem, we need to use the `String.format()` method. This method allows us to specify the format rules as a string that respects the following pattern:

```
%[flags][width][.precision]conversion-character
```

Now, let's take a look at what represents each component of this pattern:

- `[flags]` is optional and consists of standard approaches for modifying the output. Often, they are used for formatting integers and floating-point numbers.
- `[width]` is optional and sets the field width for our output (the minimum number of characters written to the output).
- `[.precision]` is optional and specifies the number of digits of precision for floating-point values (or the length of a substring to extract from a `String`).
- `conversion-character` is mandatory and tells us how the argument will be formatted. The most used conversion-characters are as follows:
 - `s`: Used for formatting strings
 - `d`: Used for formatting decimal integers
 - `f`: Used for formatting floating-point numbers
 - `t`: Used for formatting date/time values



As a line separator, we can use `%n`.

With this knowledge of formatting rules, we can obtain what we want as follows (`%6s` is used for the integers while `%.3f` is used for the doubles):

```
Path path = Paths.get("withformatter.txt");

try (BufferedWriter bw = Files.newBufferedWriter(path,
    StandardCharsets.UTF_8, StandardOpenOption.CREATE,
    StandardOpenOption.WRITE)) {

    for (int i = 0; i < 10; i++) {
        bw.write(String.format("| %6s | %.3f |",
            intValues[i], doubleValues[i]));
        bw.newLine();
    }
}
```

Another solution can be provided via the `Formatter` class. This class is dedicated to format strings and uses the same formatting rules as `String.format()`. It has a `format()` method, which we can use to rewrite the preceding snippet of code:

```
Path path = Paths.get("withformatter.txt");

try (Formatter output = new Formatter(path.toFile())) {

    for (int i = 0; i < 10; i++) {
        output.format("| %6s | %.3f |%n", intValues[i], doubleValues[i]);
    }
}
```

How about formatting only the integer's numbers?

78,910 bytes
83,222 bytes
5,593 bytes
57,329 bytes
61,443 bytes
9,043 bytes
474 bytes
45,763 bytes
26,671 bytes
24,096 bytes

Well, we can obtain this by applying a `DecimalFormat` and a string formatter, as follows:

```
Path path = Paths.get("withformatter.txt");
DecimalFormat formatter = new DecimalFormat("###,### bytes");

try (Formatter output = new Formatter(path.toFile())) {

    for (int i = 0; i < 10; i++) {
        output.format("%12s%n", formatter.format(intValues[i]));
    }
}
```

148. Working with Scanner

`Scanner` exposes an API for parsing text from strings, files, the console, and so on. Parsing is the process of tokenizing the given input and returning it as needed (for example, integers, floats, doubles, and so on). By default, `Scanner` parses the given input by using a white space (default delimiter) and exposes the tokens via a suite of `nextFoo()` methods (for example, `next()`, `nextLine()`, `nextInt()`, `nextDouble()`, and so on).



From the same category of problems, consider the *Tokenizing files* section as well.

For example, let's assume that we have a file (`doubles.txt`) that contains double numbers separated by spaces, as shown in the following illustration:

```
doubles.txt
23.4556 1.23 4.55 2.33
5.663 956.34343 23.2333
0.3434 0.788
```

If we want to obtain this text as doubles, then we can read it and rely on a snippet of *spaghetti* code to tokenize and convert it into doubles. Alternatively, we can rely on `Scanner` and its `nextDouble()` method, as follows:

```
try (Scanner scanDoubles = new Scanner(
    Path.of("doubles.txt"), StandardCharsets.UTF_8)) {

    while (scanDoubles.hasNextDouble()) {
```

```
        double number = scanDoubles.nextDouble();
        System.out.println(number);
    }
}
```

The output of the preceding code is as follows:

```
23.4556
1.23
...
```

However, a file may contain mixed information of different types. For example, the file (`people.txt`) in the following illustration contains strings and integers that are separated by different delimiters (a comma and a semicolon):

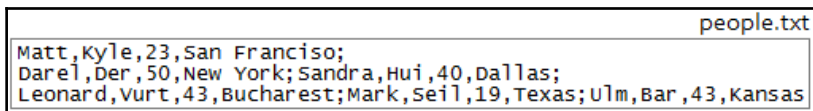

```
people.txt
Matt,Kyle,23,San Francisco;
Darel,Der,50,New York;Sandra,Hui,40,Dallas;
Leonard,Vurt,43,Bucharest;Mark,Seil,19,Texas;Ulm,Bar,43,Kansas
```

`Scanner` exposes a method called `useDelimiter()`. This method takes an argument of the `String` or `Pattern` type in order to specify the delimiter(s) that should be used as a regular expression:

```
try (Scanner scanPeople = new Scanner(Path.of("people.txt"),
    StandardCharsets.UTF_8).useDelimiter(";|,")) {

    while (scanPeople.hasNextLine()) {
        System.out.println("Name: " + scanPeople.next().trim());
        System.out.println("Surname: " + scanPeople.next());
        System.out.println("Age: " + scanPeople.nextInt());
        System.out.println("City: " + scanPeople.next());
    }
}
```

The output of using this method is as follows:

```
Name: Matt
Surname: Kyle
Age: 23
City: San Francisco
...
```

Starting with JDK 9, `Scanner` exposes a new method called `tokens()`. This method returns a stream of delimiter-separated tokens from `Scanner`. For example, we can use it to parse the `people.txt` file and print it on the console, as follows:

```
try (Scanner scanPeople = new Scanner(Path.of("people.txt"),
    StandardCharsets.UTF_8).useDelimiter(";|, ")) {

    scanPeople.tokens().forEach(t -> System.out.println(t.trim()));
}
```

The output of using the preceding method is as follows:

```
Matt
Kyle
23
San Francisco
...
```

Alternatively, we can join the tokens by space:

```
try (Scanner scanPeople = new Scanner(Path.of("people.txt"),
    StandardCharsets.UTF_8).useDelimiter(";|, ")) {

    String result = scanPeople.tokens()
        .map(t -> t.trim())
        .collect(Collectors.joining(" "));
}
```



In the *Searching in big files* section, there is an example of how to use this method to search for a certain piece of text in a file.

The output of using the preceding method is as follows:

```
Matt Kyle 23 San Francisco Darel Der 50 New York ...
```

In terms of the `tokens()` methods, JDK 9 also comes with a method called `findAll()`. This is a very handy method for finding all the tokens that respect a certain regular expression (provided as a `String` or `Pattern`). This method returns a `Stream<MatchResult>` and can be used like so:

```
try (Scanner sc = new Scanner(Path.of("people.txt"))) {

    Pattern pattern = Pattern.compile("[0-9]");

    List<String> ages = sc.findAll(pattern)
```

```
        .map(MatchResult::group)
        .collect(Collectors.toList());

    System.out.println("Ages: " + ages);
}
```

The preceding code selects all the tokens that represent ages between 40 and 49 years old, that is, 40, 43, and 43.

`Scanner` is a convenient approach to use if we wish to parse the input that's provided in the console:

```
Scanner scanConsole = new Scanner(System.in);

String name = scanConsole.nextLine();
String surname = scanConsole.nextLine();
int age = scanConsole.nextInt();
// an int cannot include "\n" so we need
// the next line just to consume the "\n"
scanConsole.nextLine();
String city = scanConsole.nextLine();
```



Note that, for numeric inputs (read via `nextInt()`, `nextFloat()`, and so on), we need to consume the newline character as well (this occurs when we hit *Enter*). Basically, `Scanner` will not fetch this character when parsing a number, and so it will go in the next token. If we don't consume it by adding a `nextLine()` code line then, from this point forward, the inputs will become unaligned and lead to an exception of the `InputMismatchException` type or come to a premature end.

The `Scanner` constructors that support charsets were introduced in JDK 10.

Let's take a look at the difference between `Scanner` and `BufferedReader`.

Scanner versus BufferedReader

So, should we use `Scanner` or `BufferedReader`? Well, if we need to parse the file, then `Scanner` is the way to go; otherwise, `BufferedReader` is more suitable. A head-to-head comparison of them will reveal the following:

- `BufferedReader` is faster than `Scanner` since it doesn't perform any parsing operations.
- `BufferedReader` excels when it comes to reading while `Scanner` excels when it comes to parsing.
- By default, `BufferedReader` uses a buffer of 8 KB, while `Scanner` uses a buffer of 1 KB.
- `BufferedReader` is a good fit for reading long strings, while `Scanner` is better for short inputs.
- `BufferedReader` is synchronized, but `Scanner` is not.
- A `Scanner` can use a `BufferedReader`, while the opposite is not possible. This is shown in the following code:

```
try (Scanner scanDoubles = new Scanner(Files.newBufferedReader(
    Path.of("doubles.txt"), StandardCharsets.UTF_8)) {
    ...
}
```

Summary

We've reached the end of this chapter, where we covered various I/O-specific problems. From manipulating, walking, and watching paths to streaming files and efficient ways of reading/writing text and binary files, we have covered a lot.

Download the applications from this chapter to view the results and additional details.

7

Java Reflection Classes, Interfaces, Constructors, Methods, and Fields

This chapter includes 17 problems that involve the Java Reflection API. From classical topics such as inspecting and instantiating Java artifacts (for example, modules, packages, classes, interfaces, superclasses, constructors, methods, annotations, and arrays) to *synthetic* and *bridge* constructs or nest-based access control (JDK 11), this chapter provides solid coverage of the Java Reflection API. By the end of this chapter, the Java Reflection API will have no secrets left unturned, and you will be ready to show your colleagues what reflection can do.

Problems

Use the following problems to test your Java Reflection API programming prowess. I strongly encourage you to give each problem a try before you turn to the solutions and download the example programs:

149. **Inspecting packages:** Write several examples for inspecting Java packages (for example, names, a list of classes, and so on).
150. **Inspecting classes and superclasses:** Write several examples for inspecting classes and superclasses (for example, get `Class` via the class name, modifiers, implemented interfaces, constructors, methods, and fields).
151. **Instantiating via a reflected constructor:** Write a program that creates instances via reflection.

152. **Getting the annotation of a receiver type:** Write a program that gets the annotation on a receiver type.
153. **Getting synthetic and bridge constructs:** Write a program that gets *synthetic* and *bridge* constructs via reflection.
154. **Checking the variable number of arguments:** Write a program that checks whether a method gets a variable number of arguments.
155. **Checking default methods:** Write a program that checks whether a method is default.
156. **Nest-based access control via reflection:** Write a program that provides access to nest-based constructs via reflection.
157. **Reflection for getters and setters:** Write several examples that invoke getters and setters via reflection. Additionally, write a program that generates getters and setters via reflection.
158. **Reflecting annotations:** Write several examples of fetching different kinds of annotations via reflection.
159. **Invoking an instance method:** Write a program that invokes an instance method via reflection.
160. **Getting `static` methods:** Write a program that groups the `static` methods of the given class and invokes one of them via reflection.
161. **Getting generic types of methods, fields, and exceptions:** Write a program that fetches the generic types of the given methods, fields, and exceptions via reflection.
162. **Getting public and private fields:** Write a program that fetches the `public` and `private` fields of the given class via reflection.
163. **Working with arrays:** Write several examples for working with arrays via reflection.
164. **Inspecting modules:** Write several examples for inspecting Java 9 modules via reflection.
165. **Dynamic proxies:** Write a program that relies on *dynamic proxies* for counting the number of invocations of the methods of the given interfaces.

Solutions

The following sections describe the solutions to the preceding problems. Remember that there usually isn't a single correct way to solve a particular problem. Also, remember that the explanations that are shown here only include the most interesting and important details that are needed to solve the problems. You can download the example solutions to view additional details and experiment with the programs from <https://github.com/PacktPublishing/Java-Coding-Problems>.

149. Inspecting packages

The `java.lang.Package` class is our main focus when we need to obtain information about a specific package. Using this class, we can find out the package's name, the vendor that implemented this package, its title, the version of the package, and so on.

This class is commonly used to find the name of a package that contains a certain class. For example, the package name of the `Integer` class can be easily obtained as follows:

```
Class clazz = Class.forName("java.lang.Integer");
Package packageOfClazz = clazz.getPackage();

// java.lang
String packageNameOfClazz = packageOfClazz.getName();
```

Now, let's find the package name of the `File` class:

```
File file = new File(".");
Package packageOfFile = file.getClass().getPackage();

// java.io
String packageNameOfFile = packageOfFile.getName();
```



If we are trying to find the package name of the current class, then we can rely on `this.getClass().getPackage().getName()`. This works in a non-static context.

But if all we want is to quickly list all the packages of the current class loader, then we can rely on the `getPackages()` method, as follows:

```
Package[] packages = Package.getPackages();
```

Based on the `getPackages()` method, we can list all the packages defined by the caller's class loader, as well as its ancestors, which start with a given prefix, as follows:

```
public static List<String> fetchPackagesByPrefix(String prefix) {  
  
    return Arrays.stream(Package.getPackages())  
        .map(Package::getName)  
        .filter(n -> n.startsWith(prefix))  
        .collect(Collectors.toList());  
}
```

If this method lives in a utility class named `Packages`, then we can call it as follows:

```
List<String> packagesSamePrefix  
    = Packages.fetchPackagesByPrefix("java.util");
```

You will see output similar to the following:

```
java.util.function, java.util.jar, java.util.concurrent.locks,  
java.util.spi, java.util.logging, ...
```

Sometimes, we just want to list all the classes of a package in the system class loader. Let's see how we can do this.

Getting the classes of a package

For example, we may want to list the classes from one of the packages of the current application (for example, the `modern.challenge` package) or the classes from one of the packages from our compile-time libraries (for example, `commons-lang-2.4.jar`).

Classes are wrapped in packages that can be archived in JARs, though they don't have to be. In order to cover both cases, we need to discover whether the given package lives in a JAR or not. We can do this by loading the resource via `ClassLoader.getSystemClassLoader().getResource(package_path)` and checking the returned URL of the resource. If the package doesn't live in a JAR, then a resource will be a URL starting with the `file:` scheme, as in the following example (we are using `modern.challenge`):

```
file:/D:/Java%20Modern%20Challenge/Code/Chapter%207/Inspect%20packages  
/build/classes/modern/challenge
```

But if the package is inside a JAR (for example, `org.apache.commons.lang3.builder`), then the URL will start with the `jar:` scheme, as in the following example:

```
jar:file:/D:/.../commons-  
lang3-3.9.jar!/org/apache/commons/lang3/builder
```

If we take into consideration that a resource of a package from a JAR starts with the `jar:` prefix, then we can write a method to distinguish between them, as follows:

```
private static final String JAR_PREFIX = "jar:";  
  
public static List<Class<?>> fetchClassesFromPackage(  
    String packageName) throws URISyntaxException, IOException {  
  
    List<Class<?>> classes = new ArrayList<>();  
    String packagePath = packageName.replace('.', '/');  
  
    URL resource = ClassLoader  
        .getSystemClassLoader().getResource(packagePath);  
  
    if (resource != null) {  
        if (resource.toString().startsWith(JAR_PREFIX)) {  
            classes.addAll(fetchClassesFromJar(resource, packageName));  
        } else {  
            File file = new File(resource.toURI());  
            classes.addAll(fetchClassesFromDirectory(file, packageName));  
        }  
    } else {  
        throw new RuntimeException("Resource not found for package: "  
            + packageName);  
    }  
  
    return classes;  
}
```

So, if the given package is in a JAR, then we call another helper method, `fetchClassesFromJar()`; otherwise, we call this helper method, `fetchClassesFromDirectory()`. As their names suggest, these helpers know how to extract the classes of the given package from a JAR or from a directory.

Mainly, these two methods are just some snippets of *spaghetti* code that are meant to identify the files that have the `.class` extension. Each class is passed through `Class.forName()` to ensure that it is returned as `Class`, not as `String`. Both methods are available in the code bundled with this book.

How about listing the classes from packages that are not in the system class loader, for example, a package from an external JAR? A convenient way to accomplish this relies on `URLClassLoader`. This class is used to load classes and resources from a search path of URLs that refer to both JAR files and directories. We will deal only with JARs, but it is pretty straightforward to do this for directories as well.

So, based on the given path, we need to fetch all the JARs and return them as `URL[]` (this array is needed to define `URLClassLoader`). For example, we can rely on the `Files.find()` method to traverse the given path and extract all the JARs, like so:

```
public static URL[] fetchJarsUrlsFromClasspath(Path classpath)
    throws IOException {

    List<URL> urlsOfJars = new ArrayList<>();
    List<File> jarFiles = Files.find(
        classpath,
        Integer.MAX_VALUE,
        (path, attr) -> !attr.isDirectory() &&
            path.toString().toLowerCase().endsWith(JAR_EXTENSION))
        .map(Path::toFile)
        .collect(Collectors.toList());

    for (File jarFile: jarFiles) {

        try {
            urlsOfJars.add(jarFile.toURI().toURL());
        } catch (MalformedURLException e) {
            logger.log(Level.SEVERE, "Bad URL for{0} {1}",
                new Object[] {
                    jarFile, e
                });
        }
    }

    return urlsOfJars.toArray(URL[]::new);
}
```

Notice that we are scanning all the subdirectories, starting with the given path. Of course, this is a design decision and it is easy to parameterize the depth of searching. For now, let's fetch the JARs from the `tomcat8/lib` folder (there is no need to install Tomcat especially for this; just use any other local directory of JARs and do the proper modifications):

```
URL[] urls = Packages.fetchJarsUrlsFromClasspath(
    Path.of("D:/tomcat8/lib"));
```

Now, we can instantiate `URLClassLoader`:

```
URLClassLoader urlClassLoader = new URLClassLoader(  
    urls, Thread.currentThread().getContextClassLoader());
```

This will construct a new `URLClassLoader` object for the given URLs and will use the current class loader for delegation (the second argument can be `null` as well). Our `URL[]` points only to JARs, but as a rule of thumb, any `jar: scheme` URL is assumed to refer to a JAR file, and any `file: scheme` URL that ends with `/` is assumed to refer to a directory.

One of the JARs that's present in the `tomcat8/lib` folder is called `tomcat-jdbc.jar`. In this JAR, there is a package called `org.apache.tomcat.jdbc.pool`. Let's list the classes of this package:

```
List<Class<?>> classes = Packages.fetchClassesFromPackage(  
    "org.apache.tomcat.jdbc.pool", urlClassLoader);
```

The `fetchClassesFromPackage()` method is a helper that simply scans the `URL[]` array of `URLClassLoader` and fetches the classes that are in the given package. Its source code is available with the code bundled with this book.

Inspecting packages inside modules

If we go with Java 9 modularity, then our packages will live inside modules. For example, if we have a class called `Manager` in a package called `com.management` in a module called `org.tournament`, then we can fetch all the packages of this module like so:

```
Manager mgt = new Manager();  
Set<String> packages = mgt.getClass().getModule().getPackages();
```

In addition, if we want to create a class, then we need the following `Class.forName()` flavor:

```
Class<?> clazz = Class.forName(mgt.getClass()  
    .getModule(), "com.management.Manager");
```

Keep in mind that each module is represented on disk as a directory with the same name. For example, the `org.tournament` module is on disk a folder with this name. Moreover, each module is mapped as a separate JAR with this name (for example, `org.tournament.jar`). By having these coordinates in mind, it is pretty straightforward to adapt the code from this section so that it lists all the classes of a given package of a given module.

150. Inspecting classes

By using the Java Reflection API, we can examine the details of a class—an object's class name, modifiers, constructors, methods, fields, implemented interfaces, and so on.

Let's assume that we have the following `Pair` class:

```
public final class Pair<L, R> extends Tuple implements Comparable {  
  
    final L left;  
    final R right;  
  
    public Pair(L left, R right) {  
        this.left = left;  
        this.right = right;  
    }  
  
    public class Entry<L, R> {}  
    ...  
}
```

Let's also assume that we have an instance of it:

```
Pair pair = new Pair(1, 1);
```

Now, let's use reflection to get the name of the `Pair` class.

Get the name of the `Pair` class via an instance

By having an instance (an object) of `Pair`, we can find out the name of its class by calling the `getClass()` method, as well as `Class.getName()`, `Class.getSimpleName()`, and `Class.getCanonicalName()`, as shown in the following example:

```
Class<?> clazz = pair.getClass();  
  
// modern.challenge.Pair  
System.out.println("Name: " + clazz.getName());  
  
// Pair  
System.out.println("Simple name: " + clazz.getSimpleName());  
  
// modern.challenge.Pair  
System.out.println("Canonical name: " + clazz.getCanonicalName());
```



An anonymous class doesn't have simple and canonical names.

Notice that `getSimpleName()` returns the unqualified class name. Alternatively, we can obtain the class as follows:

```
Class<Pair> clazz = Pair.class;
Class<?> clazz = Class.forName("modern.challenge.Pair");
```

Getting the Pair class modifiers

In order to get the modifiers (`public`, `protected`, `private`, `final`, `static`, `abstract`, and `interface`) of a class, we can call the `Class.getModifiers()` method. This method returns an `int` value representing each modifier as a flag bit. For decoding the result, we rely on the `Modifier` class, as follows:

```
int modifiers = clazz.getModifiers();

System.out.println("Is public? "
    + Modifier.isPublic(modifiers)); // true
System.out.println("Is final? "
    + Modifier.isFinal(modifiers)); // true
System.out.println("Is abstract? "
    + Modifier.isAbstract(modifiers)); // false
```

Getting the Pair class implemented interfaces

In order to obtain the interfaces that are directly implemented by a class or interface represented by an object, we simply call `Class.getInterfaces()`. This method returns an array. Since the `Pair` class implements a single interface (`Comparable`), the returned array will contain a single element:

```
Class<?>[] interfaces = clazz.getInterfaces();

// interface java.lang.Comparable
System.out.println("Interfaces: " + Arrays.toString(interfaces));

// Comparable
System.out.println("Interface simple name: "
    + interfaces[0].getSimpleName());
```

Getting the Pair class constructors

The public constructors of a class can be obtained via the `Class.getConstructors()` class. The returned result is `Constructor<?>[]`:

```
Constructor<?>[] constructors = clazz.getConstructors();

// public modern.challenge.Pair(java.lang.Object, java.lang.Object)
System.out.println("Constructors: " + Arrays.toString(constructors));
```



For fetching all the declared constructors (for example, private and protected constructors), call `getDeclaredConstructors()`.

When searching for a certain constructor, call `getConstructor(Class<?>... parameterTypes)` or `getDeclaredConstructor(Class<?>... parameterTypes)`.

Getting the Pair class fields

All the fields of a class are accessible via the `Class.getDeclaredFields()` method. This method returns an array of `Field`:

```
Field[] fields = clazz.getDeclaredFields();

// final java.lang.Object modern.challenge.Pair.left
// final java.lang.Object modern.challenge.Pair.right
System.out.println("Fields: " + Arrays.toString(fields));
```

For fetching the actual name of the fields, we can easily provide a helper method:

```
public static List<String> getFieldNames(Field[] fields) {

    return Arrays.stream(fields)
        .map(Field::getName)
        .collect(Collectors.toList());
}
```

Now, we only receive the names of the fields:

```
List<String> fieldsName = getFieldNames(fields);

// left, right
System.out.println("Fields names: " + fieldsName);
```

Getting the value of a field can be done via a general method named `Object.get(Object obj)` and via a set of `getFoo()` methods (consider documentation for details). The `obj` represents a static or instance field. For example, let's assume the `ProcedureOutputs` class that has a private field named `callableStatement` which is of type `CallableStatement`. Let's use `Field.get()` method to access this field for checking if the `CallableStatement` is closed:

```
ProcedureOutputs procedureOutputs
    = storedProcedure.unwrap(ProcedureOutputs.class);

Field csField = procedureOutputs.getClass()
    .getDeclaredField("callableStatement");
csField.setAccessible(true);

CallableStatement cs
    = (CallableStatement) csField.get(procedureOutputs);

System.out.println("Is closed? " + cs.isClosed());
```



For fetching only the public fields, call `getFields()`. For searching for a certain field, call `getField(String fieldName)` or `getDeclaredField(String name)`.

Getting the Pair class methods

The public methods of a class are accessible via the `Class.getMethods()` method. This method returns an array of `Method`:

```
Method[] methods = clazz.getMethods();
// public boolean modern.challenge.Pair.equals(java.lang.Object)
// public int modern.challenge.Pair.hashCode()
// public int modern.challenge.Pair.compareTo(java.lang.Object)
// ...
System.out.println("Methods: " + Arrays.toString(methods));
```

For fetching the actual name of the methods, we can quickly provide a helper method:

```
public static List<String> getMethodNames(Method[] methods) {

    return Arrays.stream(methods)
        .map(Method::getName)
        .collect(Collectors.toList());
}
```

Now, we only retrieve the names of the methods:

```
List<String> methodsName = getMethodNames(methods);

// equals, hashCode, compareTo, wait, wait,
// wait, toString, getClass, notify, notifyAll
System.out.println("Methods names: " + methodsName);
```



For fetching all the declared methods (for example, private and protected), call `getDeclaredMethods()`. For searching for a certain method, call `getMethod(String name, Class<?>... parameterTypes)` or `getDeclaredMethod(String name, Class<?>... parameterTypes)`.

Getting the Pair class module

If we go with JDK 9 modularity, then our classes will live inside modules. The `Pair` class is not in a module, but we can easily get the module of a class via JDK 9's `Class.getModule()` method (if the class is not in a module, then this method returns `null`):

```
// null, since Pair is not in a Module
Module module = clazz.getModule();
```

Getting the Pair class superclass

The `Pair` class extends the `Tuple` class; therefore, the `Tuple` class is a superclass of `Pair`. We can obtain it via the `Class.getSuperclass()` method, as follows:

```
Class<?> superClass = clazz.getSuperclass();
// modern.challenge.Tuple
System.out.println("Superclass: " + superClass.getName());
```

Getting the name of a certain type

Starting with JDK 8, we can get an informative string for the name of a certain type.

This method returns the same string as one or more of `getName()`, `getSimpleName()`, or `getCanonicalName()`:

- For primitives, it returns the same for all three methods:

```
System.out.println("Type: " + int.class.getTypeName()); // int
```

- For `Pair`, it returns the same thing as `getName()` and `getCanonicalName()`:

```
// modern.challenge.Pair
System.out.println("Type name: " + clazz.getTypeName());
```

- For inner classes (like `Entry` is for `Pair`), it returns the same thing as `getName()`:

```
// modern.challenge.Pair$Entry
System.out.println("Type name: "
    + Pair.Entry.class.getTypeName());
```

- For an anonymous class, it returns the same thing as `getName()`:

```
Thread thread = new Thread() {
    public void run() {
        System.out.println("Child Thread");
    }
};

// modern.challenge.Main$1
System.out.println("Anonymous class type name: "
    + thread.getClass().getTypeName());
```

- For arrays, it returns the same thing as `getCanonicalName()`:

```
Pair[] pairs = new Pair[10];
// modern.challenge.Pair[]
System.out.println("Array type name: "
    + pairs.getClass().getTypeName());
```

Getting a string that describes the class

Starting with JDK 8, we can obtain a quick description of a class (containing modifiers, name, types parameters, and so on) via the `Class.toGenericString()` method.

Let's take a look at several examples:

```
// public final class modern.challenge.Pair<L,R>
System.out.println("Description of Pair: "
    + clazz.toGenericString());

// public abstract interface java.lang.Runnable
System.out.println("Description of Runnable: "
    + Runnable.class.toGenericString());

// public abstract interface java.util.Map<K,V>
System.out.println("Description of Map: "
    + Map.class.toGenericString());
```

Getting the type descriptor string for a class

Starting with JDK 12, we can obtain the type descriptor of a class as a `String` object via the `Class.descriptorString()` method:

```
// Lmodern/challenge/Pair;
System.out.println("Type descriptor of Pair: "
    + clazz.descriptorString());

// Ljava/lang/String;
System.out.println("Type descriptor of String: "
    + String.class.descriptorString());
```

Getting the component type of an array

For arrays only, JDK 12 provides the `Class<?> componentType()` method. This method returns the component type of the array, as shown in the following two examples:

```
Pair[] pairs = new Pair[10];
String[] strings = new String[] {"1", "2", "3"};

// class modern.challenge.Pair
System.out.println("Component type of Pair[]: "
    + pairs.getClass().componentType());
```

```
// class java.lang.String
System.out.println("Component type of String[]: "
    + strings.getClass().componentType());
```

Getting a class for an array type whose component type is described by Pair

Starting with JDK 12, we can get `Class` for an array type whose component type is described by the given class via `Class.arrayType()`:

```
Class<?> arrayClazz = clazz.arrayType();

// modern.challenge.Pair<L,R>[]
System.out.println("Array type: " + arrayClazz.toGenericString());
```

151. Instantiating via a reflected constructor

We can instantiate a class via `Constructor.newInstance()` using the Java Reflection API.

Let's consider the following class, which has four constructors:

```
public class Car {

    private int id;
    private String name;
    private Color color;

    public Car() {}

    public Car(int id, String name) {
        this.id = id;
        this.name = name;
    }

    public Car(int id, Color color) {
        this.id = id;
        this.color = color;
    }

    public Car(int id, String name, Color color) {
        this.id = id;
        this.name = name;
        this.color = color;
    }
}
```

```
    }  
  
    // getters and setters omitted for brevity  
}
```

A `Car` instance can be created via one of these four constructors. The `Constructor` class exposes a method that takes the types of the parameters of a constructor and returns a `Constructor` object that reflects the matched constructor. This method is called `getConstructor(Class<?>... parameterTypes)`.

Let's call each of the preceding constructors:

```
Class<Car> clazz = Car.class;  
  
Constructor<Car> emptyCnstr  
    = clazz.getConstructor();  
  
Constructor<Car> idNameCnstr  
    = clazz.getConstructor(int.class, String.class);  
  
Constructor<Car> idColorCnstr  
    = clazz.getConstructor(int.class, Color.class);  
  
Constructor<Car> idNameColorCnstr  
    = clazz.getConstructor(int.class, String.class, Color.class);
```

Furthermore, `Constructor.newInstance(Object... initargs)` can return an instance of `Car` that corresponds with the invoked constructor:

```
Car carViaEmptyCnstr = emptyCnstr.newInstance();  
  
Car carViaIdNameCnstr = idNameCnstr.newInstance(1, "Dacia");  
  
Car carViaIdColorCnstr = idColorCnstr  
    .newInstance(1, new Color(0, 0, 0));  
  
Car carViaIdNameColorCnstr = idNameColorCnstr  
    .newInstance(1, "Dacia", new Color(0, 0, 0));
```

Now, is time to see how we can instantiate a `private` constructor via reflection.

Instantiating a class via a private constructor

The Java Reflection API can be used to instantiate a class via its `private` constructor as well. For example, let's suppose that we have a utility class called `Cars`. Following best practices, we will define this class as `final` and with a `private` constructor to not allow instances:

```
public final class Cars {  
  
    private Cars() {}  
    // static members  
}
```

Fetching this constructor can be accomplished via `Class.getDeclaredConstructor()`, as follows:

```
Class<Cars> carsClass = Cars.class;  
Constructor<Cars> emptyCarsCnstr = carsClass.getDeclaredConstructor();
```

Calling `newInstance()` at this instance will throw `IllegalAccessException` since the invoked constructor has `private` access. However, Java Reflection allows us to modify the access level via the `flag` method, `Constructor.setAccessible()`. This time, the instantiation works as expected:

```
emptyCarsCnstr.setAccessible(true);  
Cars carsViaEmptyCnstr = emptyCarsCnstr.newInstance();
```

In order to block this approach, it is advisable to throw an error from a `private` constructor, as follows:

```
public final class Cars {  
  
    private Cars() {  
        throw new AssertionError("Cannot be instantiated");  
    }  
  
    // static members  
}
```

This time, the instantiation attempt will fail with `AssertionError`.

Instantiating a class from a JAR

Let's suppose that we have the Guava JAR in the `D:/Java Modern Challenge/Code/lib/` folder, and we want to create an instance of `CountingInputStream` and read one byte from a file.

First, we define a `URL[]` array for the Guava JAR, as follows:

```
URL[] classLoaderUrls = new URL[] {
    new URL(
        "file:///D:/Java Modern Challenge/Code/lib/guava-16.0.1.jar")
};
```

Then, we will define `URLClassLoader` for this `URL[]` array:

```
URLClassLoader urlClassLoader = new URLClassLoader(classLoaderUrls);
```

Next, we will load the target class (`CountingInputStream` is a class that counts the number of bytes that are read from `InputStream`):

```
Class<?> cisClass = urlClassLoader.loadClass(
    "com.google.common.io.CountingInputStream");
```

Once the target class has been loaded, we can fetch its constructor (`CountingInputStream` has a single constructor that wraps the given `InputStream`):

```
Constructor<?> constructor
    = cisClass.getConstructor(InputStream.class);
```

Furthermore, we can create an instance of `CountingInputStream` via this constructor:

```
Object instance = constructor.newInstance(
    new FileInputStream(Path.of("test.txt").toFile()));
```

In order to ensure that the returned instance is operational, let's call two of its methods (the `read()` method reads a single byte at once, while the `getCount()` method returns the number of read bytes):

```
Method readMethod = cisClass.getMethod("read");
Method countMethod = cisClass.getMethod("getCount");
```

Next, let's read a single byte and see what `getCount ()` returns:

```
readMethod.invoke(instance);
Object readBytes = countMethod.invoke(instance);
System.out.println("Read bytes (should be 1): " + readBytes); // 1
```

Useful snippets of code

As a bonus, let's look at several snippets of code that are commonly needed when working with reflection and constructors.

First, let's fetch the number of available constructors:

```
Class<Car> clazz = Car.class;
Constructor<?>[] cnstrs = clazz.getConstructors();
System.out.println("Car class has "
    + cnstrs.length + " constructors"); // 4
```

Now, let's see how many parameters have each of these four constructors:

```
for (Constructor<?> cnstr : cnstrs) {
    int paramCount = cnstr.getParameterCount();
    System.out.println("\nConstructor with "
        + paramCount + " parameters");
}
```

In order to get details about each parameter of a constructor, we can call `Constructor.getParameters ()`. This method returns an array of `Parameter` (this class was added in JDK 8 and it provides a comprehensive list of methods for *dissecting* a parameter):

```
for (Constructor<?> cnstr : cnstrs) {
    Parameter[] params = cnstr.getParameters();
    ...
}
```

If we just need to know the types of the parameters, then `Constructor.getParameterTypes ()` will do the job:

```
for (Constructor<?> cnstr : cnstrs) {
    Class<?>[] typesOfParams = cnstr.getParameterTypes();
    ...
}
```

152. Getting the annotation of a receiver type

Starting with JDK 8, we can use explicit *receiver* parameters. Mainly, this means that we can declare an instance method that takes a parameter of the enclosing type with the `this` Java keyword.

Via explicit *receiver* parameters, we can attach type annotations to `this`. For example, let's assume that we have the following annotation:

```
@Target({ElementType.TYPE_USE})
@Retention(RetentionPolicy.RUNTIME)
public @interface Ripe {}
```

Let's use it to annotate `this` in the `eat()` method of the `Melon` class:

```
public class Melon {
    ...
    public void eat(@Ripe Melon this) {}
    ...
}
```

In other words, we can only call the `eat()` method if the instance of `Melon` represents a ripe melon:

```
Melon melon = new Melon("Gac", 2000);

// works only if the melon is ripe
melon.eat();
```

Getting the annotation on an explicit *receiver* parameter using reflection can be accomplished via JDK 8 with the `java.lang.reflect.Executable.getAnnotatedReceiverType()` method. This method is available in the `Constructor` and `Method` classes as well, and so we can use it like so:

```
Class<Melon> clazz = Melon.class;
Method eatMethod = clazz.getDeclaredMethod("eat");

AnnotatedType annotatedType = eatMethod.getAnnotatedReceiverType();

// modern.challenge.Melon
System.out.println("Type: " + annotatedType.getType().getTypeName());

// [@modern.challenge.Ripe()]
System.out.println("Annotations: "
    + Arrays.toString(annotatedType.getAnnotations()));
```

```
// [interface java.lang.reflect.AnnotatedType]
System.out.println("Class implementing interfaces: "
    + Arrays.toString(annotatedType.getClass().getInterfaces()));

AnnotatedType annotatedOwnerType
    = annotatedType.getAnnotatedOwnerType();

// null
System.out.println("\nAnnotated owner type: " + annotatedOwnerType);
```

153. Getting synthetic and bridge constructs

By using *synthetic* constructs, we can understand almost any construct that's added by the compiler. More precisely, conforming to the Java language specification: *any constructs introduced by a Java compiler that do not have a corresponding construct in the source code must be marked as synthetic, except for default constructors, the class initialization method, and the values and valueOf() methods of the Enum class.*

There are different kinds of *synthetic* constructs (for example, fields, methods, and constructors), but let's take a look at an example of a *synthetic* field. Let's assume that we have the following class:

```
public class Melon {
    ...
    public class Slice {}
    ...
}
```

Notice that we have an inner class called `Slice`. When the code is compiled, the compiler will alter this class by adding a *synthetic* field that's meant to reference the top-level class. This *synthetic* field facilitates access to the enclosing class members from a nested class.

In order to check the presence of this *synthetic* field, let's fetch all the declared fields and count them:

```
Class<Melon.Slice> clazzSlice = Melon.Slice.class;
Field[] fields = clazzSlice.getDeclaredFields();

// 1
System.out.println("Number of fields: " + fields.length);
```

Even if we didn't explicitly declare any fields, notice that one field has been reported. Let's see whether it is *synthetic* and take a look at its name:

```
// true
System.out.println("Is synthetic: " + fields[0].isSynthetic());

// this$0
System.out.println("Name: " + fields[0].getName());
```



Similar to this example, we can check whether a method or a constructor is *synthetic* via the `Method.isSynthetic()` and `Constructor.isSynthetic()` methods.

Now, let's talk about *bridge* methods. These methods are also *synthetic*, and their goal is to handle the *type-erasure* of generics.

Consider the following `Melon` class:

```
public class Melon implements Comparator<Melon> {

    @Override
    public int compare(Melon m1, Melon m2) {
        return Integer.compare(m1.getWeight(), m2.getWeight());
    }
    ...
}
```

Here, we implement the `Comparator` interface and override the `compare()` method. Moreover, we explicitly specified that the `compare()` method takes two `Melon` instances. The compiler will proceed to perform *type-erasure* and create a new method that takes two objects, as follows:

```
public int compare(Object m1, Object m2) {
    return compare((Melon) m1, (Melon) m2);
}
```

This method is known as a *synthetic bridge* method. We can't see it, but the Java Reflection API can:

```
Class<Melon> clazz = Melon.class;
Method[] methods = clazz.getDeclaredMethods();
Method compareBridge = Arrays.asList(methods).stream()
    .filter(m -> m.isSynthetic() && m.isBridge())
    .findFirst()
    .orElseThrow();
```

```
// public int modern.challenge.Melon.compare(  
// java.lang.Object, java.lang.Object)  
System.out.println(compareBridge);
```

154. Checking the variable number of arguments

In Java, a method can receive a variable number of arguments if its signature contains an argument of the `varargs` type.

For example, the `plantation()` method takes a variable number of arguments, for example, `Seed... seeds`:

```
public class Melon {  
    ...  
    public void plantation(String type, Seed...seeds) {}  
    ...  
}
```

Now, the Java Reflection API can tell whether this method supports a variable number of arguments via the `Method.isVarArgs()` method, as follows:

```
Class<Melon> clazz = Melon.class;  
Method[] methods = clazz.getDeclaredMethods();  
  
for (Method method: methods) {  
    System.out.println("Method name: " + method.getName()  
        + " varargs? " + method.isVarArgs());  
}
```

You will receive output similar to the following:

```
Method name: plantation, varargs? true  
Method name: getWeight, varargs? false  
Method name: toString, varargs? false  
Method name: getType, varargs? false
```

155. Checking default methods

Java 8 has enriched the concept of interfaces with `default` methods. These methods are written inside interfaces and have a default implementation. For example, the `Slicer` interface has a default method called `slice()`:

```
public interface Slicer {  
  
    public void type();  
  
    default void slice() {  
        System.out.println("slice");  
    }  
}
```

Now, any implementation of `Slicer` must implement the `type()` method and, optionally, can override the `slice()` method or rely on the default implementation.

The Java Reflection API can identify a default method via the `Method.isDefault()` flag method:

```
Class<Slicer> clazz = Slicer.class;  
Method[] methods = clazz.getDeclaredMethods();  
  
for (Method method: methods) {  
    System.out.println("Method name: " + method.getName()  
        + ", is default? " + method.isDefault());  
}
```

We will receive the following output:

```
Method name: type, is default? false  
Method name: slice, is default? true
```

156. Nest-based access control via reflection

Among the features of JDK 11, we have several *hotspots* (changes at bytecode level). One of these *hotspots* is known as JEP 181, or **nest-based access control (nests)**. Basically, the *nest* term defines a new access control context that *allows classes that are logically part of the same code entity, but which are compiled with distinct class files, to access each other's private members without the need for compilers to insert accessibility-broadening bridge methods*.

So, in other words, *nests* allow nested classes to be compiled to different class files that belong to the same enclosing class. These are then allowed to access each other's private classes without the use of *synthetic/bridge* methods.

Let's consider the following code:

```
public class Car {  
  
    private String type = "Dacia";  
  
    public class Engine {  
  
        private String power = "80 hp";  
  
        public void addEngine() {  
            System.out.println("Add engine of " + power  
                + " to car of type " + type);  
        }  
    }  
}
```

Let's run `javap` (the Java class file disassembler tool that allows us to analyze the bytecode) for `Car.class` in JDK 10. The following screenshot highlights the important part of this code:

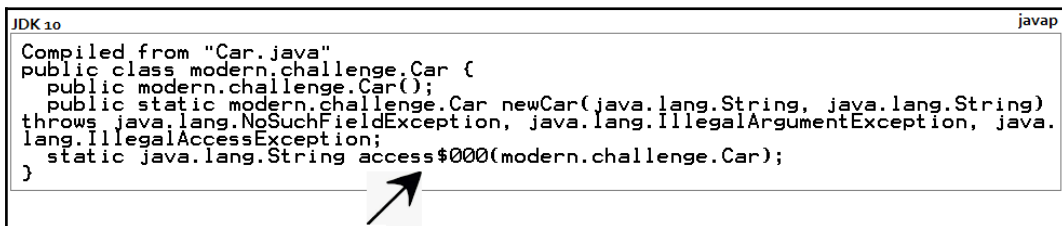

```
JDK10 javap  
Compiled from "Car.java"  
public class modern.challenge.Car {  
    public modern.challenge.Car();  
    public static modern.challenge.Car newCar(java.lang.String, java.lang.String)  
    throws java.lang.NoSuchFieldException, java.lang.IllegalArgumentException, java.  
    lang.IllegalAccessException;  
    static java.lang.String access$000(modern.challenge.Car);  
}
```

As we can see, to access the enclosing class field, `Car.type`, from the `Engine.addEngine()` method, Java has altered the code and added a *bridge* package-private method known as `access$000()`. Mainly, this is synthetically generated and can be seen via reflection using the `Method.isSynthetic()` and `Method.isBridge()` methods.

Even if we see (or perceive) the `Car` (outer) and `Engine` (nested) classes as being in the same class, they are compiled to different files (`Car.class` and `Car$Engine.class`). Conforming to this statement, our expectations imply that the outer and the nested classes can access each other's private members.

But being in separate files, this is not possible. In order to sustain our expectations, Java adds the *synthetic bridge* package-private method, `access$000()`.

However, Java 11 introduces the *nests* access control context, which provides support for `private` access within outer and nested classes. This time, the outer and nested classes are linked to two attributes and they form a *nest* (we say that they are *nestmates*). Mainly, nested classes are linked to the `NestMembers` attribute, while the outer class is linked to the `NestHost` attribute. No extra *synthetic* method is generated.

In the following screenshot, we can see `javap` being executed in JDK 11 for `Car.class` (notice the `NestMembers` attribute):

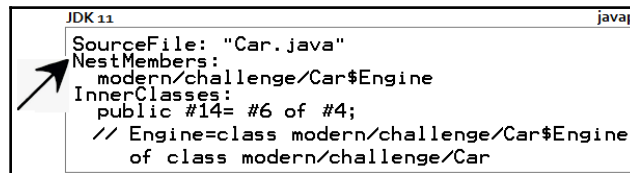

```
JDK 11                                     javap
SourceFile: "Car.java"
NestMembers:
  modern/challenge/Car$Engine
InnerClasses:
  public #14= #6 of #4;
  // Engine=class modern/challenge/Car$Engine
  of class modern/challenge/Car
```

The following screenshot shows the `javap` output in JDK 11 for `Car$Engine.class` (notice the `NestHost` attribute):

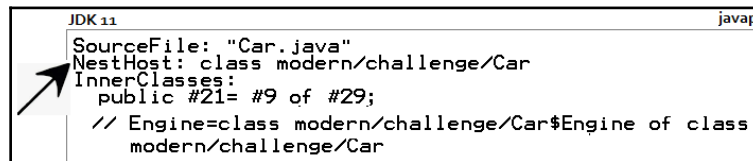

```
JDK 11                                     javap
SourceFile: "Car.java"
NestHost: class modern/challenge/Car
InnerClasses:
  public #21= #9 of #29;
  // Engine=class modern/challenge/Car$Engine of class
  modern/challenge/Car
```

Access via the Reflection API

Without nest-based access control, reflection capabilities are also limited. For example, before JDK 11, the following snippet of code would throw `IllegalAccessException`:

```
Car newCar = new Car();
Engine engine = newCar.new Engine();

Field powerField = Engine.class.getDeclaredField("power");
powerField.set(engine, power);
```

We can allow access by explicitly calling `powerField.setAccessible(true)`:

```
...
Field powerField = Engine.class.getDeclaredField("power");
powerField.setAccessible(true);
powerField.set(engine, power);
...
```

Starting with JDK 11, there is no need to call `setAccessible()`.

Moreover, JDK 11 comes with three methods that enrich the Java Reflection API with support for *nests*. These methods are `Class.getNestHost()`, `Class.getNestMembers()`, and `Class.isNestmateOf()`.

Let's consider the following `Melon` class with several nested classes (`Slice`, `Peeler`, and `Juicer`):

```
public class Melon {
    ...
    public class Slice {
        public class Peeler {}
    }

    public class Juicer {}
    ...
}
```

Now, let's define a `Class` for each of them:

```
Class<Melon> clazzMelon = Melon.class;
Class<Melon.Slice> clazzSlice = Melon.Slice.class;
Class<Melon.Juicer> clazzJuicer = Melon.Juicer.class;
Class<Melon.Slice.Peeler> clazzPeeler = Melon.Slice.Peeler.class;
```

In order to see `NestHost` of each class, we need to call `Class.getNestHost()`:

```
// class modern.challenge.Melon
Class<?> nestClazzOfMelon = clazzMelon.getNestHost();

// class modern.challenge.Melon
Class<?> nestClazzOfSlice = clazzSlice.getNestHost();

// class modern.challenge.Melon
Class<?> nestClazzOfPeeler = clazzPeeler.getNestHost();

// class modern.challenge.Melon
Class<?> nestClazzOfJuicer = clazzJuicer.getNestHost();
```

Two things should be highlighted here. First, note that `NestHost` of `Melon` is `Melon` itself. Second, note that `NestHost` of `Peeler` is `Melon`, not `Slice`. Since `Peeler` is an inner class of `Slice`, we may think that its `NestHost` is `Slice`, but this assumption is not true.

Now, let's list `NestMembers` of each class:

```
Class<?>[] nestMembersOfMelon = clazzMelon.getNestMembers();
Class<?>[] nestMembersOfSlice = clazzSlice.getNestMembers();
Class<?>[] nestMembersOfJuicer = clazzJuicer.getNestMembers();
Class<?>[] nestMembersOfPeeler = clazzPeeler.getNestMembers();
```

All of them will return same `NestMembers`:

```
[class modern.challenge.Melon, class modern.challenge.Melon$Juicer,
class modern.challenge.Melon$Slice, class
modern.challenge.Melon$$Slice$Peeler]
```

Finally, let's check *nestmates*:

```
boolean melonIsNestmateOfSlice
    = clazzMelon.isNestmateOf(clazzSlice); // true

boolean melonIsNestmateOfJuicer
    = clazzMelon.isNestmateOf(clazzJuicer); // true

boolean melonIsNestmateOfPeeler
    = clazzMelon.isNestmateOf(clazzPeeler); // true

boolean sliceIsNestmateOfJuicer
    = clazzSlice.isNestmateOf(clazzJuicer); // true

boolean sliceIsNestmateOfPeeler
    = clazzSlice.isNestmateOf(clazzPeeler); // true

boolean juicerIsNestmateOfPeeler
    = clazzJuicer.isNestmateOf(clazzPeeler); // true
```

157. Reflection for getters and setters

Just as a quick reminder, getters and setters are methods (also known as accessors) that are used for accessing the fields of a class (for example, `private` fields).

First, let's see how we can fetch the existing getters and setters. Later on, we will try to generate the missing getters and setters via reflection.

Fetching getters and setters

Mainly, there are several solutions for obtaining the getters and setters of a class via reflection. Let's assume that we want to fetch the getters and setters of the following Melon class:

```
public class Melon {

    private String type;
    private int weight;
    private boolean ripe;
    ...

    public String getType() {
        return type;
    }

    public void setType(String type) {
        this.type = type;
    }

    public int getWeight() {
        return weight;
    }

    public void setWeight(int weight) {
        this.weight = weight;
    }

    public boolean isRipe() {
        return ripe;
    }

    public void setRipe(boolean ripe) {
        this.ripe = ripe;
    }
    ...
}
```

Let's start with a solution that gets all the declared methods of a class via reflection (for example, via `Class.getDeclaredMethods()`). Now, loop `Method[]` and filter it by constraints that are specific to getters and setters (for example, start with the `get/set` prefix, return `void` or a certain type, and so on).

Another solution is getting all the declared fields of a class via reflection (for example, via `Class.getDeclaredFields()`). Now, loop `Field[]` and try to obtain the getters and setters via `Class.getDeclaredMethod()` by passing the name of the field (prefixed with `get/set/is` and the first letter capitalized) and the type of the field (in the case of setters) to it.

Finally, a more elegant solution will rely on the `PropertyDescriptor` and `Introspector` APIs. These APIs are available in the `java.beans.*` package and are dedicated to working with JavaBeans.



Many of the features that are exposed by these two classes rely on reflection behind the scene.

The `PropertyDescriptor` class can return the method that's used for reading a JavaBean property via `getReadMethod()`. Moreover, it can return the method that's used for writing a JavaBean property via `getWriteMethod()`. Relying on these two methods, we can fetch the getters and setters of the `Melon` class, as follows:

```
for (PropertyDescriptor pd:
    Introspector.getBeanInfo(Melon.class).getPropertyDescriptors()) {

    if (pd.getReadMethod() != null && !"class".equals(pd.getName())) {
        System.out.println(pd.getReadMethod());
    }

    if (pd.getWriteMethod() != null && !"class".equals(pd.getName())) {
        System.out.println(pd.getWriteMethod());
    }
}
```

The output is as follows:

```
public boolean modern.challenge.Melon.isRipe()
public void modern.challenge.Melon.setRipe(boolean)
public java.lang.String modern.challenge.Melon.getType()
public void modern.challenge.Melon.setType(java.lang.String)
public int modern.challenge.Melon.getWeight()
public void modern.challenge.Melon.setWeight(int)
```

Now, let's assume that we have the following `Melon` instance:

```
Melon melon = new Melon("Gac", 1000);
```

Here, we want to call the `getType ()` getter:

```
// the returned type is Gac
Object type = new PropertyDescriptor("type",
    Melon.class).getReadMethod().invoke(melon);
```

Now, let's call the `setWeight ()` setter:

```
// set weight of Gac to 2000
new PropertyDescriptor("weight", Melon.class)
    .getWriteMethod().invoke(melon, 2000);
```

Calling for an inexistent property will cause `IntrospectionException`:

```
try {
    Object shape = new PropertyDescriptor("shape",
        Melon.class).getReadMethod().invoke(melon);
    System.out.println("Melon shape: " + shape);
} catch (IntrospectionException e) {
    System.out.println("Property not found: " + e);
}
```

Generating getters and setters

Let's assume that `Melon` has three fields (`type`, `weight`, and `ripe`) and defines only a getter for `type` and a setter for `ripe`:

```
public class Melon {

    private String type;
    private int weight;
    private boolean ripe;
    ...

    public String getType() {
        return type;
    }

    public void setRipe(boolean ripe) {
        this.ripe = ripe;
    }
    ...
}
```

In order to generate the missing getters and setters, we start by identifying them. The following solution loops the declared fields of the given class and assumes that a `foo` field doesn't have a getter if the following apply:

- There is no `get/isFoo()` method
- The return type is not the same as the field type
- The number of arguments is not 0

For each missing getter, this solution adds in a map an entry containing the field name and type:

```
private static Map<String, Class<?>>
    fetchMissingGetters(Class<?> clazz) {

    Map<String, Class<?>> getters = new HashMap<>();
    Field[] fields = clazz.getDeclaredFields();
    String[] names = new String[fields.length];
    Class<?>[] types = new Class<?>[fields.length];

    Arrays.setAll(names, i -> fields[i].getName());
    Arrays.setAll(types, i -> fields[i].getType());

    for (int i = 0; i < names.length; i++) {
        String getterAccessor = fetchIsOrGet(names[i], types[i]);

        try {
            Method getter = clazz.getDeclaredMethod(getterAccessor);
            Class<?> returnType = getter.getReturnType();

            if (!returnType.equals(types[i]) ||
                getter.getParameterCount() != 0) {
                getters.put(names[i], types[i]);
            }
        } catch (NoSuchMethodException ex) {
            getters.put(names[i], types[i]);
            // log exception
        }
    }

    return getters;
}
```

Further, the solution loops the declared fields of the given class and assume that a `foo` field doesn't have a setter if the following apply:

- The field is not `final`
- There is no `setFoo()` method
- The method returns `void`
- The method has a single parameter
- The parameter type is the same as the field type
- If the parameter name is present, it should be the same as the name of the field

For each missing setter, this solution adds an entry containing the field name and type in a map:

```
private static Map<String, Class<?>>
    fetchMissingSetters(Class<?> clazz) {

    Map<String, Class<?>> setters = new HashMap<>();
    Field[] fields = clazz.getDeclaredFields();
    String[] names = new String[fields.length];
    Class<?>[] types = new Class<?>[fields.length];

    Arrays.setAll(names, i -> fields[i].getName());
    Arrays.setAll(types, i -> fields[i].getType());

    for (int i = 0; i < names.length; i++) {
        Field field = fields[i];
        boolean finalField = !Modifier.isFinal(field.getModifiers());

        if (finalField) {
            String setterAccessor = fetchSet(names[i]);

            try {
                Method setter = clazz.getDeclaredMethod(
                    setterAccessor, types[i]);

                if (setter.getParameterCount() != 1 ||
                    !setter.getReturnType().equals(void.class)) {

                    setters.put(names[i], types[i]);
                    continue;
                }

                Parameter parameter = setter.getParameters()[0];
                if ((parameter.isNamePresent() &&
```

```

        !parameter.getName().equals(names[i])) ||
        !parameter.getType().equals(types[i])) {
            setters.put(names[i], types[i]);
        }
    } catch (NoSuchMethodException ex) {
        setters.put(names[i], types[i]);
        // log exception
    }
}
}
}

return setters;
}

```

Well, so far, we know what fields don't have getters and setters. Their names and types are stored in a map. Let's loop the map and generate the getters:

```

public static StringBuilder generateGetters(Class<?> clazz) {

    StringBuilder getterBuilder = new StringBuilder();
    Map<String, Class<?>> accessors = fetchMissingGetters(clazz);

    for (Entry<String, Class<?>> accessor: accessors.entrySet()) {
        Class<?> type = accessor.getValue();
        String field = accessor.getKey();
        String getter = fetchIsOrGet(field, type);

        getterBuilder.append("\npublic ")
            .append(type.getSimpleName()).append(" ")
            .append(getter)
            .append("(") .append("\n")
            .append("\treturn ")
            .append(field)
            .append("; \n")
            .append("} \n");
    }

    return getterBuilder;
}

```

And let's generate the setters:

```

public static StringBuilder generateSetters(Class<?> clazz) {

    StringBuilder setterBuilder = new StringBuilder();
    Map<String, Class<?>> accessors = fetchMissingSetters(clazz);

    for (Entry<String, Class<?>> accessor: accessors.entrySet()) {

```



```
Class<?> type = accessor.getValue();
String field = accessor.getKey();
String setter = fetchSet(field);

setterBuilder.append("\npublic void ")
    .append(setter)
    .append("(").append(type.getSimpleName()).append(" ")
    .append(field).append(") {\n")
    .append("\tthis.")
    .append(field).append(" = ")
    .append(field)
    .append(";\n")
    .append("}\n");
}

return setterBuilder;
}
```

The preceding solution relies on three simple helpers listed in the following. The code is straightforward:

```
private static String fetchIsOrGet(String name, Class<?> type) {
    return "boolean".equalsIgnoreCase(type.getSimpleName()) ?
        "is" + uppercase(name) : "get" + uppercase(name);
}

private static String fetchSet(String name) {
    return "set" + uppercase(name);
}

private static String uppercase(String name) {
    return name.substring(0, 1).toUpperCase() + name.substring(1);
}
```

Now, let's call it for the `Melon` class:

```
Class<?> clazz = Melon.class;
StringBuilder getters = generateGetters(clazz);
StringBuilder setters = generateSetters(clazz);
```

The output will reveal the following generated getters and setters:

```
public int getWeight() {
    return weight;
}

public boolean isRipe() {
    return ripe;
}
```

```
}

public void setWeight(int weight) {
    this.weight = weight;
}

public void setType(String type) {
    this.type = type;
}
```

158. Reflecting annotations

Java annotations have got a lot of attention from the Java Reflection API. Let's see several solutions for inspecting several kinds of annotations (for example, package, class, and method).

Mainly, all major Reflection API classes that represent artifacts that support annotation (for example, `Package`, `Constructor`, `Class`, `Method`, and `Field`) reveal a set of common methods for working with annotations. Common methods include:

- `getAnnotations()`: Return all annotations specific to a certain artifact
- `getDeclaredAnnotations()`: Return all annotations declared directly to a certain artifact
- `getAnnotation()`: Return an annotation by type
- `getDeclaredAnnotation()`: Return an annotation by type declared directly to a certain artifact (JDK 1.8)
- `getDeclaredAnnotationsByType()`: Return all annotations by type declared directly to a certain artifact (JDK 1.8)
- `isAnnotationPresent()`: Return `true` if an annotation for the specified type is found on the given artifact



`getAnnotatedReceiverType()` was discussed earlier in the *Get annotation on receiver type* section.

In the next sections, let's talk about inspecting annotations of packages, classes, methods, and so on.

Inspecting package annotations

Annotations specific to packages are added in `package-info.java` as in the following screenshot. Here, the `modern.challenge` package was annotated with the `@Packt` annotation:

```
@Packt
package modern.challenge;
```

A convenient solution to inspect the annotations of a package starts from one of its classes. For example, if, in this package (`modern.challenge`), we have the `Melon` class, then we can obtain all annotations of this package as follows:

```
Class<Melon> clazz = Melon.class;
Annotation[] pkgAnnotations = clazz.getPackage().getAnnotations();
```

`Annotation[]` printed via `Arrays.toString()` reveals a single result:

```
[@modern.challenge.Packt ()]
```

Inspecting class annotations

The `Melon` class has a single annotation, `@Fruit`:

```
@Fruit(name = "melon", value = "delicious")
public class Melon extends @Family Cucurbitaceae
    implements @ByWeight Comparable {
```

But we can fetch all of them via `getAnnotations()`:

```
Class<Melon> clazz = Melon.class;
Annotation[] clazzAnnotations = clazz.getAnnotations();
```

The returned array printed via `Arrays.toString()` reveals a single result:

```
[@modern.challenge.Fruit (name="melon", value="delicious")]
```

In order to access the name and value attributes of an annotation, we can cast it as follows:

```
Fruit fruitAnnotation = (Fruit) clazzAnnotations[0];
System.out.println("@Fruit name: " + fruitAnnotation.name());
System.out.println("@Fruit value: " + fruitAnnotation.value());
```

Or we can use the `getDeclaredAnnotation()` method to fetch the right type directly:

```
Fruit fruitAnnotation = clazz.getDeclaredAnnotation(Fruit.class);
```

Inspecting methods annotations

Let's inspect the `@Ripe` annotation of the `eat()` method from the `Melon` class:

```
@Ripe(true)
public void eat() throws @Runtime IllegalStateException {
}
```

First, let's fetch all the declared annotations, and afterward, let's resume to `@Ripe`:

```
Class<Melon> clazz = Melon.class;
Method methodEat = clazz.getDeclaredMethod("eat");
Annotation[] methodAnnotations = methodEat.getDeclaredAnnotations();
```

The returned array printed via `Arrays.toString()` reveals a single result:

```
[@modern.challenge.Ripe(value=true)]
```

And let's cast `methodAnnotations[0]` to `Ripe`:

```
Ripe ripeAnnotation = (Ripe) methodAnnotations[0];
System.out.println("@Ripe value: " + ripeAnnotation.value());
```

Or we can use the `getDeclaredAnnotation()` method to fetch the right type directly:

```
Ripe ripeAnnotation = methodEat.getDeclaredAnnotation(Ripe.class);
```

Inspecting annotations of the thrown exceptions

For inspecting the annotations of the thrown exceptions, we need to call the `getAnnotatedExceptionTypes()` method:

```
@Ripe(true)
public void eat() throws @Runtime IllegalStateException {
}
```

This method returns the thrown exceptions types included those that are annotated:

```
Class<Melon> clazz = Melon.class;
Method methodEat = clazz.getDeclaredMethod("eat");
AnnotatedType[] exceptionsTypes
    = methodEat.getAnnotatedExceptionTypes();
```

The returned array printed via `Arrays.toString()` reveals a single result:

```
[@modern.challenge.Runtime() java.lang.IllegalStateException]
```

Extracting the first exception type can be accomplished as follows:

```
// class java.lang.IllegalStateException
System.out.println("First exception type: "
    + exceptionsTypes[0].getType());
```

Extracting the annotations of the first exception type can be done as follows:

```
// [@modern.challenge.Runtime()]
System.out.println("Annotations of the first exception type: "
    + Arrays.toString(exceptionsTypes[0].getAnnotations()));
```

Inspecting annotations of the return type

For inspecting the annotations of a method return, we need to call the `getAnnotatedReturnType()` method:

```
public @Shape("oval") List<Seed> seeds() {
    return Collections.emptyList();
}
```

This method returns the annotated return type of the given method:

```
Class<Melon> clazz = Melon.class;
Method methodSeeds = clazz.getDeclaredMethod("seeds");
AnnotatedType returnType = methodSeeds.getAnnotatedReturnType();

// java.util.List<modern.challenge.Seed>
System.out.println("Return type: "
    + returnType.getType().getTypeName());

// [@modern.challenge.Shape(value="oval")]
System.out.println("Annotations of the return type: "
    + Arrays.toString(returnType.getAnnotations()));
```

Inspecting annotations of the method's parameters

Having a method, we can inspect the annotations of its parameters by calling `getParameterAnnotations()`:

```
public void slice(@Ripe(true) @Shape("square") int noOfSlices) {
}
```

This method returns a matrix (array of arrays) containing the annotations on the formal parameters, in declaration order:

```
Class<Melon> clazz = Melon.class;
Method methodSlice = clazz.getDeclaredMethod("slice", int.class);
Annotation[][] paramAnnotations
    = methodSlice.getParameterAnnotations();
```

Fetching each parameter type with its annotations (in this case, we have an `int` parameter with two annotations) can be accomplished via `getParameterTypes()`. Since this method maintains the declaration order as well, we can extract some information, as follows:

```
Class<?>[] parameterTypes = methodSlice.getParameterTypes();

int i = 0;
for (Annotation[] annotations: paramAnnotations) {
    Class parameterType = parameterTypes[i++];
    System.out.println("Parameter: " + parameterType.getName());

    for (Annotation annotation: annotations) {
        System.out.println("Annotation: " + annotation);
        System.out.println("Annotation name: "
```

```
        + annotation.annotationType().getSimpleName());
    }
}
```

And, the output should be as follows:

```
Parameter type: int
Annotation: @modern.challenge.Ripe (value=true)
Annotation name: Ripe
Annotation: @modern.challenge.Shape (value="square")
Annotation name: Shape
```

Inspecting annotations of fields

Having a field, we can fetch its annotations via `getDeclaredAnnotations()`:

```
@Unit
private final int weight;
```

Here it is the code:

```
Class<Melon> clazz = Melon.class;
Field weightField = clazz.getDeclaredField("weight");
Annotation[] fieldAnnotations = weightField.getDeclaredAnnotations();
```

Getting the value of the `@Unit` annotation can be done as follows:

```
Unit unitFieldAnnotation = (Unit) fieldAnnotations[0];
System.out.println("@Unit value: " + unitFieldAnnotation.value());
```

Or, use the `getDeclaredAnnotation()` method to fetch the right type directly:

```
Unit unitFieldAnnotation
    = weightField.getDeclaredAnnotation(Unit.class);
```

Inspecting annotations of the superclass

For inspecting the annotations of the superclass, we need to call the `getAnnotatedSuperclass()` method:

```
@Fruit(name = "melon", value = "delicious")
public class Melon extends @Family Cucurbitaceae
    implements @ByWeight Comparable {
```

This method returns the superclass type that is annotated:

```
Class<Melon> clazz = Melon.class;
AnnotatedType superclassNameType = clazz.getAnnotatedSuperclass();
```

And let's get some information as well:

```
// modern.challenge.Cucurbitaceae
System.out.println("Superclass type: "
    + superclassNameType.getType().getTypeName());

// [@modern.challenge.Family()]
System.out.println("Annotations: "
    + Arrays.toString(superclassNameType.getDeclaredAnnotations()));

System.out.println("@Family annotation present: "
    + superclassNameType.isAnnotationPresent(Family.class)); // true
```

Inspecting annotations of interfaces

For inspecting the annotations of the implemented interfaces, we need to call the `getAnnotatedInterfaces()` method:

```
@Fruit(name = "melon", value = "delicious")
public class Melon extends @Family Cucurbitaceae
    implements @ByWeight Comparable {
```

This method returns the interfaces types that are annotated:

```
Class<Melon> clazz = Melon.class;
AnnotatedType[] interfacesTypes = clazz.getAnnotatedInterfaces();
```

The returned array printed via `Arrays.toString()` reveals a single result:

```
[@modern.challenge.ByWeight() java.lang.Comparable]
```

Extracting the first interface type can be accomplished as follows:

```
// interface java.lang.Comparable
System.out.println("First interface type: "
    + interfacesTypes[0].getType());
```

Moreover, extracting the annotations of the first interface type can be done as follows:

```
// [@modern.challenge.ByWeight()]
System.out.println("Annotations of the first exception type: "
    + Arrays.toString(interfacesTypes[0].getAnnotations()));
```

Get annotations by type

Having multiple annotations of the same type on certain components, we can fetch all of them via `getAnnotationsByType()`. For a class, we can do it as follows:

```
Class<Melon> clazz = Melon.class;
Fruit[] clazzFruitAnnotations
    = clazz.getAnnotationsByType(Fruit.class);
```

Get a declared annotation

Trying to fetch by type a single annotation declared directly on a certain artifact can be done as shown in the following example:

```
Class<Melon> clazz = Melon.class;
Method methodEat = clazz.getDeclaredMethod("eat");
Ripe methodRipeAnnotation
    = methodEat.getDeclaredAnnotation(Ripe.class);
```

159. Invoking an instance method

Let's assume that we have the following `Melon` class:

```
public class Melon {
    ...
    public Melon() {}

    public List<Melon> cultivate(
        String type, Seed seed, int noOfSeeds) {

        System.out.println("The cultivate() method was invoked ...");

        return Collections.nCopies(noOfSeeds, new Melon("Gac", 5));
    }
    ...
}
```

Our goal is to invoke the `cultivate()` method and obtain the return via the Java Reflection API.

First, let's fetch the `cultivate()` method as a `Method` via `Method.getDeclaredMethod()`. All we have to do is pass the name of the method (in this case, `cultivate()`) and the right types of parameters (`String`, `Seed`, and `int`) to `getDeclaredMethod()`. Second argument of `getDeclaredMethod()` is a varargs of `Class<?>` type, therefore, it can be empty for methods with no parameters or contain the list of parameters types as in the following example:

```
Method cultivateMethod = Melon.class.getDeclaredMethod(
    "cultivate", String.class, Seed.class, int.class);
```

Then, let's obtain an instance of the `Melon` class. We want to invoke an instance method; therefore, we need an instance. Relying on the empty constructor of `Melon` and the Java Reflection API, we can do it as follows:

```
Melon instanceMelon = Melon.class
    .getDeclaredConstructor().newInstance();
```

Finally, we focus on the `Method.invoke()` method. Mainly, we need to pass to this method the instance used for calling the `cultivate()` method and some values for the parameters:

```
List<Melon> cultivatedMelons = (List<Melon>) cultivateMethod.invoke(
    instanceMelon, "Gac", new Seed(), 10);
```

The success of invocation is revealed by the following message:

```
The cultivate() method was invoked ...
```

Moreover, if we print the return of invocation via `System.out.println()`, then we get the following result:

```
[Gac (5g), Gac (5g), Gac (5g), ...]
```

We've just cultivated 10 gacs via reflection.

160. Getting static methods

Let's assume that we have the following `Melon` class:

```
public class Melon {
    ...
    public void eat() {}

    public void weighsIn() {}
}
```

```
public static void cultivate(Seed seeds) {
    System.out.println("The cultivate() method was invoked ...");
}

public static void peel(Slice slice) {
    System.out.println("The peel() method was invoked ...");
}

// getters, setters, toString() omitted for brevity
}
```

This class has two static methods—`cultivate()` and `peel()`. Let's fetch these two methods in `List<Method>`.

The solution to this problem has two main steps:

1. Fetch all the available methods of the given class
2. Filter those that contain the static modifier via the `Modifier.isStatic()` method

In code, it looks like this:

```
List<Method> staticMethods = new ArrayList<>();

Class<Melon> clazz = Melon.class;
Method[] methods = clazz.getDeclaredMethods();

for (Method method: methods) {

    if (Modifier.isStatic(method.getModifiers())) {
        staticMethods.add(method);
    }
}
```

The result of printing the list via `System.out.println()` is as follows:

```
[public static void
    modern.challenge.Melon.peel(modern.challenge.Slice),

public static void
    modern.challenge.Melon.cultivate(modern.challenge.Seed)]
```

One step further, and we may want to call one of these two methods.

For example, let's call the `peel()` method (notice that we pass `null` instead of an instance of `Melon` since a static method doesn't need an instance):

```
Method method = clazz.getMethod("peel", Slice.class);
method.invoke(null, new Slice());
```

The output signals that the `peel()` method was successfully invoked:

```
The peel() method was invoked ...
```

161. Getting generic types of method, fields, and exceptions

Let's assume that we have the following `Melon` class (listed are only the parts relevant to this problem):

```
public class Melon<E extends Exception>
    extends Fruit<String, Seed> implements Comparable<Integer> {

    ...
    private List<Slice> slices;
    ...

    public List<Slice> slice() throws E {
        ...
    }

    public Map<String, Integer> asMap(List<Melon> melons) {
        ...
    }
    ...
}
```

The `Melon` class contains several generic types associated with different artifacts. Mainly, the generic types of super classes, interfaces, classes, methods, and fields are `ParameterizedType` instances. For each `ParameterizedType`, we need to fetch the actual type of arguments via `ParameterizedType.getActualTypeArguments()`. The `Type[]` returned by this method can be iterated to extract information about each argument, as follows:

```
public static void printGenerics(Type genericType) {

    if (genericType instanceof ParameterizedType) {
        ParameterizedType type = (ParameterizedType) genericType;
```

```
Type[] typeOfArguments = type.getActualTypeArguments();

for (Type typeOfArgument: typeOfArguments) {
    Class classTypeOfArgument = (Class) typeOfArgument;
    System.out.println("Class of type argument: "
        + classTypeOfArgument);

    System.out.println("Simple name of type argument: "
        + classTypeOfArgument.getSimpleName());
}
}
```

Now, let's see how we can deal with generics of methods.

Generics of methods

For example, let's get the generic return types for the `slice()` and `asMap()` methods. This can be accomplished via the `Method.getGenericReturnType()` method as follows:

```
Class<Melon> clazz = Melon.class;

Method sliceMethod = clazz.getDeclaredMethod("slice");
Method asMapMethod = clazz.getDeclaredMethod("asMap", List.class);

Type sliceReturnType = sliceMethod.getGenericReturnType();
Type asMapReturnType = asMapMethod.getGenericReturnType();
```

Now, calling `printGenerics(sliceReturnType)` will output the following:

```
Class of type argument: class modern.challenge.Slice
Simple name of type argument: Slice
```

And, calling `printGenerics(asMapReturnType)` will output the following:

```
Class of type argument: class java.lang.String
Simple name of type argument: String

Class of type argument: class java.lang.Integer
Simple name of type argument: Integer
```

Generic parameters of methods can be obtained via `Method.getGenericParameterTypes()`, as follows:

```
Type[] asMapParamTypes = asMapMethod.getGenericParameterTypes();
```

Further, we call `printGenerics()` for each `Type` (each generic parameter):

```
for (Type paramType: asMapParamTypes) {
    printGenerics(paramType);
}
```

Following is the output (there is a single generic parameter, `List<Melon>`):

```
Class of type argument: class modern.challenge.Melon
Simple name of type argument: Melon
```

Generics of fields

In the case of fields (for example, `slices`), generics can be fetched via `Field.getGenericType()`, as follows:

```
Field slicesField = clazz.getDeclaredField("slices");
Type slicesType = slicesField.getGenericType();
```

Calling `printGenerics(slicesType)` will output the following:

```
Class of type argument: class modern.challenge.Slice
Simple name of type argument: Slice
```

Generics of a superclass

Getting the generics of a superclass can be accomplished by calling the `getGenericSuperclass()` method of the current class:

```
Type superclassType = clazz.getGenericSuperclass();
```

Calling `printGenerics(superclassType)` will output the following:

```
Class of type argument: class java.lang.String
Simple name of type argument: String

Class of type argument: class modern.challenge.Seed
Simple name of type argument: Seed
```

Generics of interfaces

Getting the generics of implemented interfaces can be accomplished by calling the `getGenericInterfaces()` method of the current class:

```
Type[] interfacesTypes = clazz.getGenericInterfaces();
```

Further, we call `printGenerics()` for each `Type`. Following is the output (there is a single interface, `Comparable<Integer>`):

```
Class of type argument: class java.lang.Integer
Simple name of type argument: Integer
```

Generics of exceptions

Generic types of exceptions are materialized in instances of `TypeVariable` or `ParameterizedType`. This time, the helper method for extracting and printing information about generics based on `TypeVariable` can be written as follows:

```
public static void printGenericsOfExceptions(Type genericType) {
    if (genericType instanceof TypeVariable) {
        TypeVariable typeVariable = (TypeVariable) genericType;
        GenericDeclaration genericDeclaration
            = typeVariable.getGenericDeclaration();

        System.out.println("Generic declaration: " + genericDeclaration);

        System.out.println("Bounds: ");
        for (Type type: typeVariable.getBounds()) {
            System.out.println(type);
        }
    }
}
```

Having this helper, we can pass to it the exceptions thrown by a method via `getGenericExceptionTypes()`. If an exception type is a type variable (`TypeVariable`) or a parameterized type (`ParameterizedType`), it is created. Otherwise, it is resolved:

```
Type[] exceptionsTypes = sliceMethod.getGenericExceptionTypes();
```

Further, we call the `printGenerics()` for each `Type`:

```
for (Type paramType: exceptionsTypes) {
    printGenericsOfExceptions(paramType);
}
```

The output will be as follows:

```
Generic declaration: class modern.challenge.Melon
Bounds: class java.lang.Exception
```



Most probably, printing the extracted information about generics will not be useful, therefore, feel free to adapt the preceding helpers based on your needs. For example, collect the information and return it as `List`, `Map`, and so on.

162. Getting public and private fields

The solution to this problem relies on the `Modifier.isPublic()` and `Modifier.isPrivate()` methods.

Let's assume the following `Melon` class has two public fields and two private fields:

```
public class Melon {

    private String type;
    private int weight;

    public Peeler peeler;
    public Juicer juicer;
    ...
}
```

First, we need to fetch the `Field[]` array corresponding to this class via the `getDeclaredFields()` method:

```
Class<Melon> clazz = Melon.class;
Field[] fields = clazz.getDeclaredFields();
```

`Field[]` contains all the four fields from earlier. Further, let's iterate this array and let's apply `Modifier.isPublic()` and `Modifier.isPrivate()` flag methods to each `Field`:

```
List<Field> publicFields = new ArrayList<>();
List<Field> privateFields = new ArrayList<>();

for (Field field: fields) {
    if (Modifier.isPublic(field.getModifiers())) {
        publicFields.add(field);
    }

    if (Modifier.isPrivate(field.getModifiers())) {
        privateFields.add(field);
    }
}
```

The `publicFields` list contains only public fields, and the `privateFields` list contains only private fields. If we quickly print these two lists via `System.out.println()`, then the output will be as follows:

```
Public fields:
[public modern.challenge.Peeler modern.challenge.Melon.peeler,
public modern.challenge.Juicer modern.challenge.Melon.juicer]

Private fields:
[private java.lang.String modern.challenge.Melon.type,
private int modern.challenge.Melon.weight]
```

163. Working with arrays

The Java Reflection API comes with a class dedicated to working with arrays. This class is named `java.lang.reflect.Array`.

For example, the following snippet of code creates an array of `int`. The first parameter tells what type each element in the array should be of. The second parameter represents the length of the array. Therefore, an array of 10 integers can be defined via `Array.newInstance()` as follows:

```
int[] arrayOfInt = (int[]) Array.newInstance(int.class, 10);
```

Using Java Reflection, we can alter the content of an array. There is a general `set()` method and a bunch of `setFoo()` methods (for example, `setInt()`, and `setFloat()`). Setting the value at index 0 to 100 can be done as follows:

```
Array.setInt(arrayOfInt, 0, 100);
```

Fetching a value from an array can be accomplished via the `get()` and `getFoo()` methods (these methods get the array and the index as arguments and return the value from the specified index):

```
int valueIndex0 = Array.getInt(arrayOfInt, 0);
```

Getting the Class of an array can be done as follows:

```
Class<?> stringClass = String[].class;
Class<?> clazz = arrayOfInt.getClass();
```

And we can extract the type of the array via `getComponentType()`:

```
// int
Class<?> typeInt = clazz.getComponentType();

// java.lang.String
Class<?> typeString = stringClass.getComponentType();
```

164. Inspecting modules

Java 9 has added the concept of *modules* via the Java Platform Module System. Basically, a module is a set of packages managed by that module (for example, the module decides which packages are visible outside the module).

An application with two modules can be shaped as in the following screenshot:

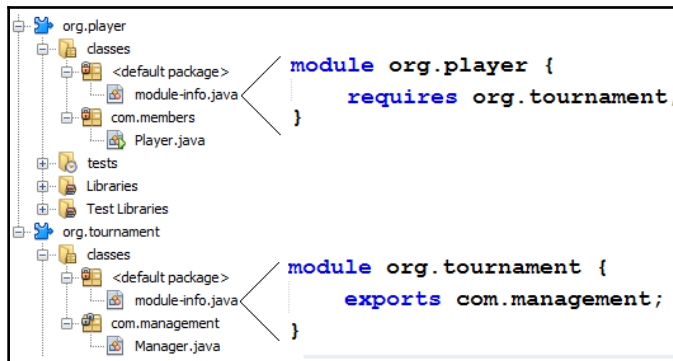

There are two modules—`org.player` and `org.tournament`. The `org.player` module requires the `org.tournament` module, and the `org.tournament` module exports the `com.management` package.

Java Reflection API represents a module via the `java.lang.Module` class (in the `java.base` module). Via the Java Reflection API, we can extract information or modify a module.

For start, we can obtain a `Module` instance as in the following two examples:

```
Module playerModule = Player.class.getModule();
Module managerModule = Manager.class.getModule();
```

The name of a module can be obtained via the `Module.getName()` method:

```
// org.player
System.out.println("Class 'Player' is in module: "
    + playerModule.getName());

// org.tournament
System.out.println("Class 'Manager' is in module: "
    + managerModule.getName());
```

Having a `Module` instance, we can call several methods for getting different information. For example, we can find out whether a module is named or it has exported or opened a certain package:

```
boolean playerModuleIsNamed = playerModule.isNamed(); // true
boolean managerModuleIsNamed = managerModule.isNamed(); // true

boolean playerModulePnExported
    = playerModule.isExported("com.members"); // false
boolean managerModulePnExported
    = managerModule.isExported("com.management"); // true

boolean playerModulePnOpen
    = playerModule.isOpen("com.members"); // false
boolean managerModulePnOpen
    = managerModule.isOpen("com.management"); // false
```

Beside getting information, the `Module` class allows us to alter a module. For example, the `org.player` module doesn't export the `com.members` package to the `org.tournament` module. We can check this quickly:

```
boolean before = playerModule.isExported(
    "com.members", managerModule); // false
```

But we can alter this via reflection. We can perform this export via the `Module.addExports()` method (in the same category we have `addOpens()`, `addReads()`, and `addUses()`):

```
playerModule.addExports("com.members", managerModule);
```

Now, let's check again:

```
boolean after = playerModule.isExported(
    "com.members", managerModule); // true
```

A module also takes advantages of its own descriptor. The `ModuleDescriptor` class can be used as the starting point for working with a module:

```
ModuleDescriptor descriptorPlayerModule
    = playerModule.getDescriptor();
```

For example, we can fetch the packages of a module as follows:

```
Set<String> pcks = descriptorPlayerModule.packages();
```

165. Dynamic proxies

Dynamic proxies can be used to support the implementation of different functionalities that are part of the **Cross Cutting-Concerns (CCC)** category. CCC are those concerns that represent ancillary functionalities of the core functionalities, such as database connection management, transaction management (for example, `Spring @Transactional`), security, and logging.

More precisely, Java Reflection comes with a class named `java.lang.reflect.Proxy`, the main purpose of which is to provide support for creating dynamic implementations of interfaces at runtime. `Proxy` reflects on the concrete interface's implementation at runtime.

We can think of `Proxy` as a *front-wrapper* that pass our invocations to the right methods. Optionally, `Proxy` can interfere in the process before delegating the invocation.

Dynamic proxies rely on a single class (`InvocationHandler`) with a single method (`invoke()`) as in the following diagram:

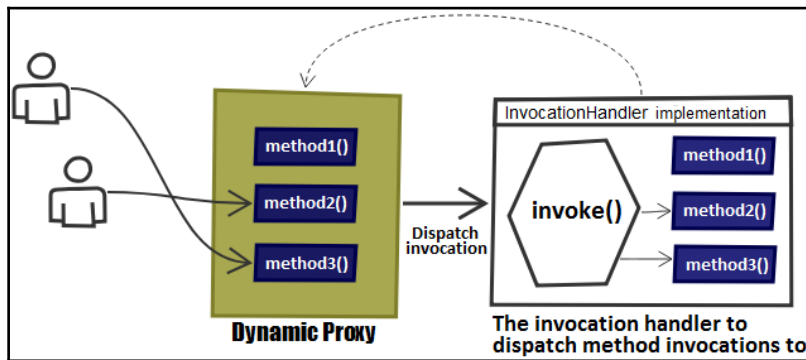

If we depict the flow from this diagram, then we obtain the following steps:

1. The actors call the needed methods through the exposed *dynamic proxy* (for example, if we want to call the `List.add()` method, we will do it through a dynamic proxy, not directly)
2. The dynamic proxy will dispatch the invocation to an instance of an `InvocationHandler` implementation (each proxy instance has an associated invocation handler)
3. The dispatched invocation will hit the `invoke()` method as a triad containing the proxy object, the method to invoke (as a `Method` instance) and an array of arguments for this method
4. The `InvocationHandler` will run additional optional functionalities (for example, CCC) and will invoke the corresponding method
5. The `InvocationHandler` will return the result of invocation as an object

If we try to resume this flow, then we can say that a dynamic proxy sustains invocations of multiple methods of arbitrary classes via a single class (`InvocationHandler`) with a single method (`invoke()`).

Implementing a dynamic proxy

For example, let's write a dynamic proxy that counts the number of invocations of the methods of `List`.

A dynamic proxy is created via the `Proxy.newProxyInstance()` method. The `newProxyInstance()` methods takes three parameters:

- `ClassLoader`: This is used to load the dynamic proxy class
- `Class<?>[]`: This is the array of interfaces to implement
- `InvocationHandler`: This is the invocation handler to dispatch method invocations to

Check out this example:

```
List<String> listProxy = (List<String>) Proxy.newProxyInstance(
    List.class.getClassLoader(), new Class[] {
        List.class}, invocationHandler);
```

This snippet of code returns a dynamic implementation of the `List` interface. Further, all invocations via this proxy will be dispatched to the `invocationHandler` instance.

Mainly, a skeleton of an `InvocationHandler` implementation looks as follows:

```
public class DummyInvocationHandler implements InvocationHandler {

    @Override
    public Object invoke(Object proxy, Method method, Object[] args)
        throws Throwable {
        ...
    }
}
```

Since we want to count the number of invocations of the methods of `List`, we should store all methods signatures and the number of invocations for each of them. This can be accomplished via `Map` initialized in the constructor of `CountingInvocationHandler` as follows (this is our `InvocationHandler` implementation, and `invocationHandler` is an instance of it):

```
public class CountingInvocationHandler implements InvocationHandler {

    private final Map<String, Integer> counter = new HashMap<>();
    private final Object targetObject;

    public CountingInvocationHandler(Object targetObject) {
        this.targetObject = targetObject;

        for (Method method:targetObject.getClass().getDeclaredMethods()) {
            this.counter.put (method.getName()
                + Arrays.toString(method.getParameterTypes()), 0);
        }
    }
}
```

```
    }  
    ...  
}
```

The `targetObject` field holds the implementation of the `List` interface (in this case, `ArrayList`).

And we create a `CountingInvocationHandler` instance as follows:

```
CountingInvocationHandler invocationHandler  
    = new CountingInvocationHandler(new ArrayList<>());
```

The `invoke()` method simply counts the invocations and invokes `Method` with the specified arguments:

```
@Override  
public Object invoke(Object proxy, Method method, Object[] args)  
    throws Throwable {  
  
    Object resultOfInvocation = method.invoke(targetObject, args);  
    counter.computeIfPresent(method.getName()  
        + Arrays.toString(method.getParameterTypes()), (k, v) -> ++v);  
  
    return resultOfInvocation;  
}
```

Finally, we expose a method that returns the number of invocations for the given method:

```
public Map<String, Integer> countOf(String methodName) {  
  
    Map<String, Integer> result = counter.entrySet().stream()  
        .filter(e -> e.getKey().startsWith(methodName + "["))  
        .filter(e -> e.getValue() != 0)  
        .collect(Collectors.toMap(Entry::getKey, Entry::getValue));  
  
    return result;  
}
```

The code bundled to this book glues these snippets of code in a class named `CountingInvocationHandler`.

At this moment, we can use `listProxy` to call several methods, as follows:

```
listProxy.add("Adda");  
listProxy.add("Mark");  
listProxy.add("John");  
listProxy.remove("Adda");  
listProxy.add("Marcel");  
listProxy.remove("Mark");  
listProxy.add(0, "Akiuy");
```

And let's see how many times we invoked the `add()` and `remove()` methods:

```
// {add[class java.lang.Object]=4, add[int, class java.lang.Object]=1}  
invocationHandler.countOf("add");  
  
// {remove[class java.lang.Object]=2}  
invocationHandler.countOf("remove");
```



Since the `add()` method has been invoked via two of its signatures, the resulted `Map` contains two entries.

Summary

This was the last problem of this chapter. Hopefully, we have finished this comprehensive traversal of the Java Reflection API. We have covered in detail problems regarding classes, interfaces, constructors, methods, fields, annotations, and so on.

Download the applications from this chapter to see the results and to see additional details.

8

Functional Style Programming - Fundamentals and Design Patterns

This chapter includes 11 problems that involve Java functional-style programming. We will start with a problem that's meant to provide a complete journey from 0 to functional interfaces. Then, we will continue by looking at a suite of design patterns from GoF that we will interpret in Java functional style.

By the end of this chapter, you should be familiar with functional-style programming and ready to continue with a set of problems that allow us to deep dive into this topic. You should be able to use a bunch of commonly used design patterns written in functional-style and have a very good understanding of how to evolve code to take advantage of functional interfaces.

Problems

Use the following problems to test your functional style programming prowess. I strongly encourage you to give each problem a try before you turn to the solutions and download the example programs:

166. **Writing functional interfaces:** Write a program to define the road from 0 to a functional interface via a set of meaningful examples.
167. **Lambdas in a nutshell:** Explain what a lambda expression is.
168. **Implementing the Execute Around pattern:** Write a program that represents an implementation of the Execute Around pattern based on lambdas.

169. **Implementing the Factory pattern:** Write a program that represents an implementation of the Factory pattern based on lambdas.
170. **Implementing the Strategy pattern:** Write a program that represents an implementation of the Strategy pattern based on lambdas.
171. **Implementing the Template Method pattern:** Write a program that represents an implementation of the Template Method pattern based on lambdas.
172. **Implementing the Observer pattern:** Write a program that represents an implementation of the Observer pattern based on lambdas.
173. **Implementing the Loan pattern:** Write a program that represents an implementation of the Loan pattern based on lambdas.
174. **Implementing the Decorator pattern:** Write a program that represents an implementation of the Decorator pattern based on lambdas.
175. **Implementing the Cascaded Builder pattern:** Write a program that represents an implementation of the Cascaded Builder pattern based on lambdas.
176. **Implementing the Command pattern:** Write a program that represents an implementation of the Command pattern based on lambdas.

Solutions

The following sections describe solutions to the preceding problems. Remember that there usually isn't a single correct way to solve a particular problem. Also, remember that the explanations that are shown here only include the most interesting and important details that are needed to solve these problems. You can download the example solutions to view additional details and experiment with the programs from <https://github.com/PacktPublishing/Java-Coding-Problems>.

166. Writing functional interfaces

In this solution, we will highlight the purpose and usability of a functional interface in comparison with several alternatives. We will look at how to evolve the code from its basic and rigid implementation to a flexible implementation based on a functional interface. For this, let's consider the following `Melon` class:

```
public class Melon {  
  
    private final String type;
```

```
private final int weight;
private final String origin;

public Melon(String type, int weight, String origin) {
    this.type = type;
    this.weight = weight;
    this.origin = origin;
}

// getters, toString(), and so on omitted for brevity
}
```

Let's assume that we have a client – let's call him Mark – who wants to start up a melon-selling business. We shaped the preceding class based on his description. His main goal is to have an inventory application that will sustain his ideas and decisions, so an application needs to be created that must grow based on business requirements and evolution. We'll take a look at the time that's needed to develop this application on a daily basis in the following sections.

Day 1 (filtering melons by their type)

One day, Mark asked us to provide a feature for filtering melons by their type. As a result, we created a utility class named `Filters` and implemented a `static` method that takes a list of melons and the type to filter on as arguments.

The resulting method is pretty straightforward:

```
public static List<Melon> filterByType(
    List<Melon> melons, String type) {

    List<Melon> result = new ArrayList<>();

    for (Melon melon: melons) {
        if (melon != null && type.equalsIgnoreCase(melon.getType())) {
            result.add(melon);
        }
    }

    return result;
}
```

Done! Now, we can easily filter melons by type, as shown in the following example:

```
List<Melon> bailans = Filters.filterByType(melons, "Bailan");
```

Day 2 (filtering melons of a certain weight)

While Mark was satisfied with the result, he requested another filter to obtain melons of a certain weight (for example, all the melons that are 1,200 grams). We've just implemented a filter like this for melon types, and so we can come up with a new static method for melons of a certain weight, as follows:

```
public static List<Melon> filterByWeight(
    List<Melon> melons, int weight) {

    List<Melon> result = new ArrayList<>();

    for (Melon melon: melons) {
        if (melon != null && melon.getWeight() == weight) {
            result.add(melon);
        }
    }

    return result;
}
```

This is similar to `filterByType()`, except it has a different condition/filter. As developers, we are starting to understand that, if we continue like this, then the `Filters` class will end up with a lot of methods that simply repeat the code and use a different condition. We are very close to a *boilerplate code* case here.

Day 3 (filtering melons by type and weight)

Things are getting even worse. Mark has now asked us to add a new filter that filters melons by type and weight, and he needs this quickly. However, the quickest implementation is the ugliest. Check it out:

```
public static List<Melon> filterByTypeAndWeight(
    List<Melon> melons, String type, int weight) {
    List<Melon> result = new ArrayList<>();

    for (Melon melon: melons) {
        if (melon != null && type.equalsIgnoreCase(melon.getType())
            && melon.getWeight() == weight) {
            result.add(melon);
        }
    }

    return result;
}
```

In our context, this is unacceptable. If we add a new filter criterion here, the code will become hard to maintain as well as prone to errors.

Day 4 (pushing the behavior as a parameter)

Meeting time! We cannot continue to add more filters like this; filtering with every attribute we can think of will end up in a huge `Filters` class that has big, complex methods with too many parameters and tons of *boilerplate* code.

The main problem is that we have different behaviors wrapped in *boilerplate* code. So, it will be nice to write the *boilerplate* code only once and push the behavior as a parameter. This way, we can shape any selection condition/criteria as behavior and juggle them as desired. The code will become more clear, flexible, easy to maintain, and have fewer parameters.

This is known as **Behavior Parameterization**, which is illustrated in the following diagram (the left-hand side shows what we have now; the right-hand side shows what we want):

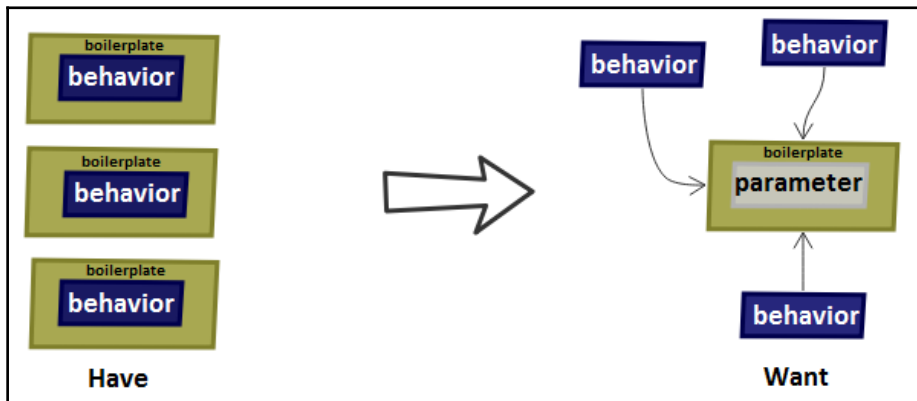

If we think of each selection condition/criteria as a behavior, then it is pretty intuitive to think of each behavior as an implementation of an interface. Basically, all these behaviors have something in common – a selection condition/criteria and a return of the `boolean` type (this is known as a **predicate**). In the context of an interface, this is a contract that can be written as follows:

```
public interface MelonPredicate {
    boolean test(Melon melon);
}
```

Furthermore, we can write different implementations of `MelonPredicate`. For example, filtering the `Gac` melons can be written like this:

```
public class GacMelonPredicate implements MelonPredicate {
    @Override
    public boolean test(Melon melon) {
        return "gac".equalsIgnoreCase(melon.getType());
    }
}
```

Alternatively, filtering all the melons that are heavier than 5,000g can be written:

```
public class HugeMelonPredicate implements MelonPredicate {
    @Override
    public boolean test(Melon melon) {
        return melon.getWeight() > 5000;
    }
}
```

This technique has a name – the Strategy design pattern. According to GoF, this can *"Define a family of algorithms, encapsulate each one, and make them interchangeable. The strategy pattern lets the algorithm vary independently from client to client."*

So, the main idea is to dynamically select the behavior of an algorithm at runtime. The `MelonPredicate` interface unifies all the algorithms dedicated to selecting melons, and each implementation of it is a strategy.

At the moment, we have the strategies, but we don't have any method that receives a `MelonPredicate` parameter. We need a `filterMelons()` method, as shown in the following diagram:

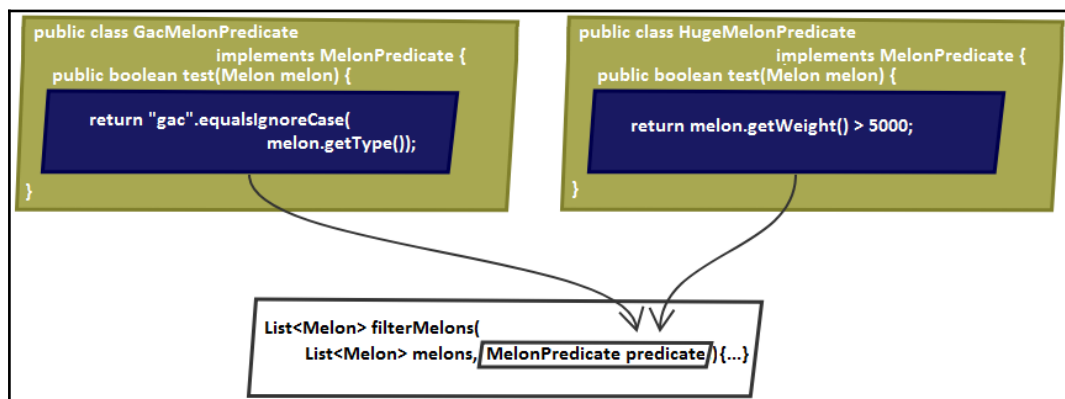

So, we need a single parameter and multiple behaviors. Let's look at the source code for `filterMelons()`:

```
public static List<Melon> filterMelons(
    List<Melon> melons, MelonPredicate predicate) {

    List<Melon> result = new ArrayList<>();

    for (Melon melon: melons) {
        if (melon != null && predicate.test(melon)) {
            result.add(melon);
        }
    }

    return result;
}
```

This is much better! We can reuse this method with different behaviors as follows (here, we pass `GacMelonPredicate` and `HugeMelonPredicate`):

```
List<Melon> gacs = Filters.filterMelons(
    melons, new GacMelonPredicate());

List<Melon> huge = Filters.filterMelons(
    melons, new HugeMelonPredicate());
```

Day 5 (implementing another 100 filters)

Mark has asked us to implement another 100 filters. This time, we have the flexibility and the support to accomplish this task, but we still need to write 100 strategies or classes for implementing the `MelonPredicate` for each selection criteria. Moreover, we have to create instances of these strategies and pass them to the `filterMelons()` method.

This means a lot of code and time. In order to save both, we can rely on Java anonymous classes. In other words, having classes with no names that are declared and instantiated at the same time will result in something like this:

```
List<Melon> europeans = Filters.filterMelons(
    melons, new MelonPredicate() {
    @Override
    public boolean test(Melon melon) {
        return "europe".equalsIgnoreCase(melon.getOrigin());
    }
});
```

There is some progress being made here, but this is not very significant because we still need to write a lot of code. Check the highlighted code in the following diagram (this code repeats for each implemented behavior):

```
List<Melon> europeans = Filters.filterMelons(
    melons, new MelonPredicate() {
    @Override
    public boolean test(Melon melon) {
        return "europe".equalsIgnoreCase(melon.getOrigin());
    }
});
```

Here, the code is not friendly. Anonymous classes seem complex and they somehow look incomplete and weird, especially to novices.

Day 6 (anonymous classes can be written as lambdas)

A new day, a new idea! Any smart IDE can show us the road ahead. For example, the NetBeans IDE will discretely warn us that this anonymous class can be written as a lambda expression.

This is shown in the following screenshot:

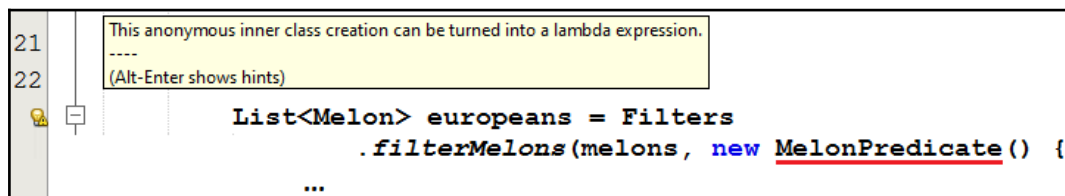

The message is crystal clear – **This anonymous inner class creation can be turned into a lambda expression.** Here, make the transformation by hand or let the IDE do it for us.

The result will look like this:

```
List<Melon> europeansLambda = Filters.filterMelons(
    melons, m -> "europe".equalsIgnoreCase(m.getOrigin()));
```

This is much better! Java 8 lambda expressions did a great job this time. Now, we can write Mark's filters in a more flexible, fast, clean, readable, and maintainable manner.

Day 7 (abstracting the List type)

Mark comes up with some good news the next day – he will extend his business and sell other fruits as well as melons. This is cool, but our predicate only supports `Melon` instances.

So, how should we proceed to support other fruits too? How many other fruits? What if Mark decides to start selling another category of products, such as vegetables? We cannot simply create a predicate for each of them. This will take us back to the start.

The obvious solution is to abstract the `List` type. We start this by defining a new interface, and this time name it `Predicate` (remove `Melon` from the name):

```
@FunctionalInterface
public interface Predicate<T> {
    boolean test(T t);
}
```

Next, we rewrite the `filterMelons()` method and rename it as `filter()`:

```
public static <T> List<T> filter(
    List<T> list, Predicate<T> predicate) {

    List<T> result = new ArrayList<>();

    for (T t: list) {
        if (t != null && predicate.test(t)) {
            result.add(t);
        }
    }

    return result;
}
```

Now, we can write filters for `Melon`:

```
List<Melon> watermelons = Filters.filter(
    melons, (Melon m) -> "Watermelon".equalsIgnoreCase(m.getType()));
```

We can also do the same for numbers:

```
List<Integer> numbers = Arrays.asList(1, 13, 15, 2, 67);
List<Integer> smallThan10 = Filters
    .filter(numbers, (Integer i) -> i < 10);
```

Take a step back and look at where we started and where we are now. The difference is huge thanks to Java 8 functional interfaces and lambda expressions. Have you noticed the `@FunctionalInterface` annotation on the `Predicate` interface? Well, that is an informative annotation type that's used to mark a functional interface. It is useful for an error to occur if the marked interface is not functional.

Conceptually, a functional interface has exactly one abstract method. Moreover, the `Predicate` interface that we've defined already exists in Java 8 as the `java.util.function.Predicate` interface. The `java.util.function` package contains 40+ such interfaces. Consequently, before defining a new one, it is advisable to check this package's content. Most of the time, the six standard built-in functional interfaces will do the job. These are listed as follows:

- `Predicate<T>`
- `Consumer<T>`
- `Supplier<T>`
- `Function<T, R>`
- `UnaryOperator<T>`
- `BinaryOperator<T>`

Functional interfaces and lambda expressions make a great team. Lambda expressions support the implementation of the abstract method of a functional interface directly inline. Basically, the entire expression is perceived as an instance of a concrete implementation of the functional interface, as demonstrated in the following code:

```
Predicate<Melon> predicate = (Melon m)
    -> "Watermelon".equalsIgnoreCase(m.getType());
```

167. Lambdas in a nutshell

Dissecting a lambda expression will reveal three main parts, as shown in the following diagram:



The following is a description of each part of a lambda expression:

- On the left-hand side of the arrow, we have the parameters of this lambda that are used in the lambda body. These are the parameters of the `FilenameFilter.accept(File folder, String fileName)` method.
- On the right-hand of the arrow, we have the lambda body, which in this case checks if the folder in which the file was found can be read and if the file name ends with the `.pdf` suffix.
- The arrow is just a separator of the lambda's parameters and body.

The anonymous class version of this lambda is as follows:

```
FilenameFilter filter = new FilenameFilter() {
    @Override
    public boolean accept(File folder, String fileName) {
        return folder.canRead() && fileName.endsWith(".pdf");
    }
};
```

Now, if we look at the lambda and the anonymous version of it, then we can conclude that a lambda expression is a concise anonymous function that can be passed as an argument to a method or kept in a variable. We can conclude that a lambda expression can be described according to the four words shown in the following diagram:

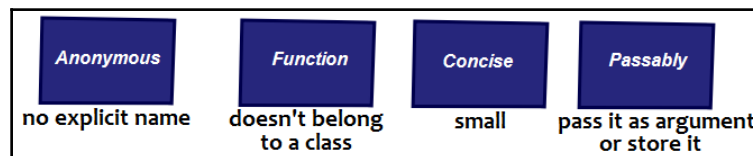

Lambdas sustain Behavior Parameterization and that is a big plus (check the previous problem for a detailed explanation of this). Finally, keep in mind that lambdas can be used only in the context of a functional interface.

168. Implementing the Execute Around pattern

The Execute Around pattern tries to eliminate the *boilerplate* code that surrounds specific tasks. For example, the tasks specific to a file need to be surrounded by code for the purpose of opening and closing the file.

Mainly, the Execute Around pattern is useful in scenarios that imply tasks that take place inside a resource open-close lifespan. For example, let's assume that we have a `Scanner` and that our first task consists of reading a `double` value from a file:

```
try (Scanner scanner = new Scanner(
    Path.of("doubles.txt"), StandardCharsets.UTF_8)) {

    if (scanner.hasNextDouble()) {
        double value = scanner.nextDouble();
    }
}
```

Later on, another task consists of printing all `double` values:

```
try (Scanner scanner = new Scanner(
    Path.of("doubles.txt"), StandardCharsets.UTF_8)) {
    while (scanner.hasNextDouble()) {
        System.out.println(scanner.nextDouble());
    }
}
```

The following diagram highlights the *boilerplate* code that surrounds these two tasks:

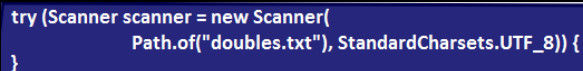

```
try (Scanner scanner = new Scanner(
    Path.of("doubles.txt"), StandardCharsets.UTF_8)) {
}
```

In order to avoid this *boilerplate* code, the Execute Around pattern relies on Behavior Parameterization (further detailed in the *Writing functional interfaces* section). The steps that are needed to accomplish this are as follows:

1. The first step is to define a functional interface that matches the `Scanner` -> `double` signature, which may throw an `IOException`:

```
@FunctionalInterface
public interface ScannerDoubleFunction {
    double readDouble(Scanner scanner) throws IOException;
}
```

Declaring the functional interface is just half of the solution.

2. So far, we can write a lambda of the `Scanner` `-> double` type, but we need a method that receives it and executes it. For this, let's consider the following method in the `Doubles` utility class:

```
public static double read(ScannerDoubleFunction snf)
    throws IOException {

    try (Scanner scanner = new Scanner(
        Path.of("doubles.txt"), StandardCharsets.UTF_8)) {

        return snf.readDouble(scanner);
    }
}
```

The lambda that's passed to the `read()` method is executed inside the body of this method. When we pass the lambda, we provide an implementation of the abstract method known as `readDouble()` directly inline. Mainly, this is perceived as an instance of the functional interface, `ScannerDoubleFunction`, and so we can call the `readDouble()` method to obtain the desired result.

3. Now, we can simply pass our tasks as lambdas and reuse the `read()` method. For example, our tasks can be wrapped in two `static` methods, as shown here (this practice is needed to obtain clean code and avoid big lambdas):

```
private static double getFirst(Scanner scanner) {
    if (scanner.hasNextDouble()) {
        return scanner.nextDouble();
    }

    return Double.NaN;
}

private static double sumAll(Scanner scanner) {
    double sum = 0.0d;
    while (scanner.hasNextDouble()) {

        sum += scanner.nextDouble();
    }

    return sum;
}
```

4. Having these two tasks as examples, we can write other tasks as well. Let's pass them to the `read()` method:

```
double singleDouble
    = Doubles.read((Scanner sc) -> getFirst(sc));
double sumAllDoubles
    = Doubles.read((Scanner sc) -> sumAll(sc));
```

The Execute Around pattern is quite useful for eliminating the *boilerplate* code that's specific for opening and closing resources (I/O operations).

169. Implementing the Factory pattern

In a nutshell, the Factory pattern allows us to create several kinds of objects without exposing the instantiation process to the caller. This way, we can hide the complex and/or sensitive process of creating objects and expose an intuitive and easy-to-use factory of objects to the caller.

In a classic implementation, the Factory pattern relies on an intern `switch()`, as shown in the following example:

```
public static Fruit newInstance(Class<?> clazz) {
    switch (clazz.getSimpleName()) {
        case "Gac":
            return new Gac();
        case "Hemi":
            return new Hemi();
        case "Cantaloupe":
            return new Cantaloupe();
        default:
            throw new IllegalArgumentException(
                "Invalid clazz argument: " + clazz);
    }
}
```

Here, `Gac`, `Hemi`, and `Cantaloupe` are implementing the same `Fruit` interface and have an empty constructor. If this method lives in a utility class named `MelonFactory`, we can call it as follows:

```
Gac gac = (Gac) MelonFactory.newInstance(Gac.class);
```

However, Java 8 functional-style allows us to refer to constructors using the *method references* technique. This means that we can define a `Supplier<Fruit>` to refer to the `Gac` empty constructor, as follows:

```
Supplier<Fruit> gac = Gac::new;
```

How about `Hemi`, `Cantaloupe`, and so on? Well, we can simply put all of them in a `Map` (notice that no melon type is instantiated here; these are just lazy *method references*):

```
private static final Map<String, Supplier<Fruit>> MELONS
    = Map.of("Gac", Gac::new, "Hemi", Hemi::new,
            "Cantaloupe", Cantaloupe::new);
```

Furthermore, we can rewrite the `newInstance()` method to use this map:

```
public static Fruit newInstance(Class<?> clazz) {
    Supplier<Fruit> supplier = MELONS.get(clazz.getSimpleName());
    if (supplier == null) {
        throw new IllegalArgumentException(
            "Invalid clazz argument: " + clazz);
    }
    return supplier.get();
}
```

The caller code doesn't need any further modifications:

```
Gac gac = (Gac) MelonFactory.newInstance(Gac.class);
```

However, obviously, constructors are not always empty. For example, the following `Melon` class exposes a single constructor with three arguments:

```
public class Melon implements Fruit {
    private final String type;
    private final int weight;
    private final String color;

    public Melon(String type, int weight, String color) {
        this.type = type;
        this.weight = weight;
        this.color = color;
    }
}
```

Creating an instance of this class cannot be obtained via an empty constructor. But if we define a functional interface that supports three arguments and a return, then we are back on track:

```
@FunctionalInterface
public interface TriFunction<T, U, V, R> {
    R apply(T t, U u, V v);
}
```

This time, the following statement will try to fetch a constructor with three arguments of the `String`, `Integer`, and `String` types:

```
private static final
    TriFunction<String, Integer, String, Melon> MELON = Melon::new;
```

The `newInstance()` method, which was made especially for the `Melon` class is:

```
public static Fruit newInstance(
    String name, int weight, String color) {
    return MELON.apply(name, weight, name);
}
```

A `Melon` instance can be created as follows:

```
Melon melon = (Melon) MelonFactory.newInstance("Gac", 2000, "red");
```

Done! Now, we have a factory of `Melon` via functional interfaces.

170. Implementing the Strategy pattern

The classic Strategy pattern is pretty straightforward. It consists of an interface that represents a family of algorithms (strategies) and several implementations of this interface (each implementation is a strategy).

For example, the following interface unifies the strategies for removing characters from the given string:

```
public interface RemoveStrategy {
    String execute(String s);
}
```

First, we will define a strategy for removing numeric values from a string:

```
public class NumberRemover implements RemoveStrategy {
    @Override
    public String execute(String s) {
        return s.replaceAll("\\d", "");
    }
}
```

Then, we will define a strategy for removing white spaces from a string:

```
public class WhitespacesRemover implements RemoveStrategy {
    @Override
    public String execute(String s) {
        return s.replaceAll("\\s", "");
    }
}
```

Finally, let's define a utility class that acts as the entry point for strategies:

```
public final class Remover {

    private Remover() {
        throw new AssertionError("Cannot be instantiated");
    }

    public static String remove(String s, RemoveStrategy strategy) {
        return strategy.execute(s);
    }
}
```

This is a simple and classical Strategy pattern implementation. If we want to remove numeric values from a string, we can do this as follows:

```
String text = "This is a text from 20 April 2050";
String noNr = Remover.remove(text, new NumberRemover());
```

But do we actually need the `NumberRemover` and `WhitespacesRemover` classes? Do we need to write similar classes for further strategies? Obviously, the answer is no.

Check out our interface one more time:

```
@FunctionalInterface
public interface RemoveStrategy {
    String execute(String s);
}
```

We've just added the `@FunctionalInterface` hint because the `RemoveStrategy` interface defines a single abstract method, and so it is a functional interface.

What can we use in the context of a functional interface? Well, the obvious answer is lambdas. Moreover, what can a lambda do for us in this scenario? It can remove the *boilerplate* code (in this case, the classes representing the strategies) and encapsulate the strategy in its body:

```
String noNr = Remover.remove(text, s -> s.replaceAll("\\d", ""));
String noWs = Remover.remove(text, s -> s.replaceAll("\\s", ""));
```

So, this is what the Strategy pattern looks like via lambdas.

171. Implementing the Template Method pattern

The Template Method is a classical design pattern from GoF that allows us to write a skeleton of an algorithm in a method and defer certain steps of this algorithm to the client subclasses.

For example, making a pizza involves three main steps – preparing the dough, adding toppings, and baking the pizza. While the first and last step can be considered the same (fixed steps) for all pizzas, the second step is different for each type of pizza (variable step).

If we put this in code via the Template Method pattern, then we obtain something like the following (the `make()` method represents the template method and contains the fixed and variable steps in a well-defined order):

```
public abstract class PizzaMaker {

    public void make(Pizza pizza) {
        makeDough(pizza);
        addTopIngredients(pizza);
        bake(pizza);
    }

    private void makeDough(Pizza pizza) {
        System.out.println("Make dough");
    }

    private void bake(Pizza pizza) {
        System.out.println("Bake the pizza");
    }
}
```

```
    }  
  
    public abstract void addTopIngredients(Pizza pizza);  
}
```

The fixed steps have default implementations while the variable step is represented by an abstract method called `addTopIngredients()`. This method is implemented by subclasses of this class. For example, a Neapolitan pizza will be abstracted as follows:

```
public class NeapolitanPizza extends PizzaMaker {  
  
    @Override  
    public void addTopIngredients(Pizza p) {  
        System.out.println("Add: fresh mozzarella, tomatoes,  
            basil leaves, oregano, and olive oil ");  
    }  
}
```

On the other hand, a Greek pizza will be as follows:

```
public class GreekPizza extends PizzaMaker {  
  
    @Override  
    public void addTopIngredients(Pizza p) {  
        System.out.println("Add: sauce and cheese");  
    }  
}
```

So, each type of pizza requires a new class that overrides the `addTopIngredients()` method. In the end, we can make a pizza like so:

```
Pizza nPizza = new Pizza();  
PizzaMaker nMaker = new NeapolitanPizza();  
nMaker.make(nPizza);
```

The drawback of this approach consists of *boilerplate* code and verbosity. However, we can tackle this drawback via lambdas. We can represent the variable steps of the Template Method as lambdas expressions. Depending on the case, we have to choose the proper functional interfaces. In our case, we can rely on a `Consumer`, as follows:

```
public class PizzaLambda {  
  
    public void make(Pizza pizza, Consumer<Pizza> addTopIngredients) {  
        makeDough(pizza);  
        addTopIngredients.accept(pizza);  
        bake(pizza);  
    }  
}
```

```
    }

    private void makeDough(Pizza p) {
        System.out.println("Make dough");
    }

    private void bake(Pizza p) {
        System.out.println("Bake the pizza");
    }
}
```

This time, there is no need to define subclasses (no need to have `NeapolitanPizza`, `GreekPizza`, or others). We just pass the variable step via a lambda expression. Let's make a Sicilian pizza:

```
Pizza sPizza = new Pizza();
new PizzaLambda().make(sPizza, (Pizza p)
    -> System.out.println("Add: bits of tomato, onion,
        anchovies, and herbs "));
```

Done! No more *boilerplate* code is needed. The lambda solution has seriously improved the solution.

172. Implementing the Observer pattern

In a nutshell, the Observer pattern relies on an object (known as the **subject**) that automatically notifies its subscribers (known as **observers**) when certain events happen.

For example, the fire station headquarters can be the *subject*, and the local fire stations can be the *observers*. When a fire has started, the fire station headquarters notifies all local fire stations and sends them the address where the fire is taking place. Each *observer* analyzes the received address and, depending on different criteria, decides whether to extinguish the fire or not.

All the local fire stations are grouped via an interface called `FireObserver`. This method defines a single abstract method that is invoked by the fire station headquarters (*subject*):

```
public interface FireObserver {
    void fire(String address);
}
```

Each local fire station (*observer*) implements this interface and decides whether to extinguish the fire or not in the `fire()` implementation. Here, we have three local stations (Brookhaven, Vinings, and Decatur):

```
public class BrookhavenFireStation implements FireObserver {

    @Override
    public void fire(String address) {
        if (address.contains("Brookhaven")) {
            System.out.println(
                "Brookhaven fire station will go to this fire");
        }
    }
}

public class ViningsFireStation implements FireObserver {
    // same code as above for ViningsFireStation
}

public class DecaturFireStation implements FireObserver {
    // same code as above for DecaturFireStation
}
```

Half of the job is done! Now, we need to register these *observers* to be notified by the *subject*. In other words, each local fire station needs to be registered as an *observer* to the fire station headquarters (*subject*). For this, we declare another interface that defines the *subject* contract for registering and notifying its *observers*:

```
public interface FireStationRegister {
    void registerFireStation(FireObserver fo);
    void notifyFireStations(String address);
}
```

Finally, we can write the fire station headquarters (*subject*):

```
public class FireStation implements FireStationRegister {

    private final List<FireObserver> fireObservers = new ArrayList<>();

    @Override
    public void registerFireStation(FireObserver fo) {
        if (fo != null) {
            fireObservers.add(fo);
        }
    }

    @Override
```

```
public void notifyFireStations(String address) {
    if (address != null) {
        for (FireObserver fireObserver: fireObservers) {
            fireObserver.fire(address);
        }
    }
}
```

Now, let's register our three local stations (*observers*) to the fire station headquarters (*subject*):

```
FireStation fireStation = new FireStation();
fireStation.registerFireStation(new BrookhavenFireStation());
fireStation.registerFireStation(new DecaturFireStation());
fireStation.registerFireStation(new ViningsFireStation());
```

Now, when a fire occurs, the fire station headquarters will notify all registered local fire stations:

```
fireStation.notifyFireStations(
    "Fire alert: WestHaven At Vinings 5901 Suffex Green Ln Atlanta");
```

The Observer pattern was successfully implemented there.

This is another classical case of *boilerplate* code. Each local fire station needs a new class and implementation of the `fire()` method.

However, lambdas can help us again! Check out the `FireObserver` interface. It has a single abstract method; therefore, this is a functional interface:

```
@FunctionalInterface
public interface FireObserver {
    void fire(String address);
}
```

This functional interface is an argument of the `Fire.registerFireStation()` method. In this context, we can pass a lambda to this method instead of a new instance of a local fire station. The lambda will contain the behavior in its body; therefore, we can delete the local station classes and rely on lambdas, as follows:

```
fireStation.registerFireStation((String address) -> {
    if (address.contains("Brookhaven")) {
        System.out.println(
            "Brookhaven fire station will go to this fire");
    }
});
```

```
fireStation.registerFireStation((String address) -> {
    if (address.contains("Vinings")) {
        System.out.println("Vinings fire station will go to this fire");
    }
});

fireStation.registerFireStation((String address) -> {
    if (address.contains("Decatur")) {
        System.out.println("Decatur fire station will go to this fire");
    }
});
```

Done! No more *boilerplate* code.

173. Implementing the Loan pattern

In this problem, we will talk about implementing the Loan pattern. Let's assume that we have a file containing three numbers (let's say, doubles), and each number is a coefficient of a formula. For example, the numbers x , y , and z are the coefficients of the following two formulas: $x+y-z$ and $x-y*\sqrt{z}$. In the same manner, we can write other formulas as well.

At this point, we have enough experience to recognize that this scenario sounds like a good fit for Behavior Parameterization. This time, we don't define a custom functional interface, and we use a built-in functional interface called `Function<T, R>`. This functional interface represents a function that accepts one argument and produces a result. The signature of its abstract method is `R apply(T t)`.

This functional interface becomes an argument of a `static` method that's meant to implement the Loan pattern. Let's place this method in a class called `Formula`:

```
public class Formula {
    ...
    public static double compute(
        Function<Formula, Double> f) throws IOException {
        ...
    }
}
```

Notice that the `compute()` method accepts lambdas of the `Formula -> Double` type while it is declared in the `Formula` class. Let's reveal the entire source code of `compute()`:

```
public static double compute(
    Function<Formula, Double> f) throws IOException {

    Formula formula = new Formula();
    double result = 0.0 d;

    try {
        result = f.apply(formula);
    } finally {
        formula.close();
    }

    return result;
}
```

There are three points that should be highlighted here. First, when we create a new instance of `Formula`, we actually open a new `Scanner` to our file (check the private constructor of this class):

```
public class Formula {

    private final Scanner scanner;
    private double result;

    private Formula() throws IOException {
        result = 0.0 d;

        scanner = new Scanner(
            Path.of("doubles.txt"), StandardCharsets.UTF_8);
    }
    ...
}
```

Second, when we execute the lambda, we are actually calling a chain of instance methods of `Formula` that perform the computation (apply the formula). Each of these methods returns the current instance. The instance methods that should be called are defined in the body of the lambda expression.

We only need the following computations, but more can be added:

```
public Formula add() {
    if (scanner.hasNextDouble()) {
        result += scanner.nextDouble();
    }

    return this;
}

public Formula minus() {
    if (scanner.hasNextDouble()) {
        result -= scanner.nextDouble();
    }

    return this;
}

public Formula multiplyWithSqrt() {
    if (scanner.hasNextDouble()) {
        result *= Math.sqrt(scanner.nextDouble());
    }

    return this;
}
```

Since the result of the computation (the formula) is a double, we need to provide a **Terminal** method that returns the final result:

```
public double result() {
    return result;
}
```

Finally, we close the `Scanner` and reset the result. This takes place in the `private close()` method:

```
private void close() {
    try (scanner) {
        result = 0.0 d;
    }
}
```

These pieces have been glued into the code bundled with this book under a class named `Formula`.

Now, do you remember our formulas? We had $x+y-z$ and $x-y*\sqrt{z}$. The first one can be written as follows:

```
double xPlusYMinusZ = Formula.compute((sc)
-> sc.add().add().minus().result());
```

The second formula can be written as follows:

```
double xMinusYMultiplySqrtZ = Formula.compute((sc)
-> sc.add().minus().multiplyWithSqrt().result());
```

Notice that we can focus on our formulas and we don't need to bother with opening and closing the file. Moreover, the fluent API allows us to shape any formula and it is very easy to enrich it with more operations.

174. Implementing the Decorator pattern

The Decorator pattern prefers composition over inheritance; therefore, it is an elegant alternative to the subclassing technique. With this, we mainly start from a base object and add additional features in a dynamic fashion.

For example, we can use this pattern to decorate a cake. The decoration process doesn't change the cake itself – it just adds some nuts, cream, fruit, and so on.

The following diagram illustrates what we will implement:

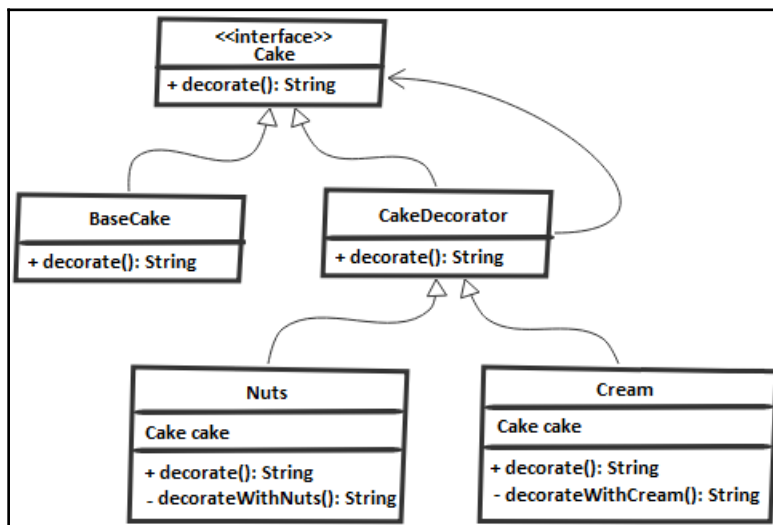

First, we create an interface called `Cake`:

```
public interface Cake {
    String decorate();
}
```

Then, we implement this interface via `BaseCake`:

```
public class BaseCake implements Cake {

    @Override
    public String decorate() {
        return "Base cake ";
    }
}
```

Afterward, we create an abstract `CakeDecorator` class for this `Cake`. The main goal of this class is to call the `decorate()` method of the given `Cake`:

```
public class CakeDecorator implements Cake {

    private final Cake cake;

    public CakeDecorator(Cake cake) {
        this.cake = cake;
    }

    @Override
    public String decorate() {
        return cake.decorate();
    }
}
```

Next, we focus on writing our decorators.

Each decorator extends `CakeDecorator` and alters the `decorate()` method to add the corresponding decoration.

For example, the `Nuts` decorator looks like this:

```
public class Nuts extends CakeDecorator {

    public Nuts(Cake cake) {
        super(cake);
    }

    @Override
    public String decorate() {
```

```
        return super.decorate() + decorateWithNuts();
    }

    private String decorateWithNuts() {
        return "with Nuts ";
    }
}
```

For brevity purposes, we skip the `Cream` decorator. However, it is pretty straightforward to intuit that this decorator is mostly the same as `Nuts`.

So, again, we have some *boilerplate* code.

Now, we can create a `Cake` decorated with nuts and cream, as follows:

```
Cake cake = new Nuts(new Cream(new BaseCake()));
// Base cake with Cream with Nuts

System.out.println(cake.decorate());
```

So, this is a classical implementation of the Decorator pattern. Now, let's take a look at the lambda-based implementation, which drastically reduces this code. This is especially the case when we have a significant number of decorators.

This time, we transform the `Cake` interface into a class, as follows:

```
public class Cake {

    private final String decorations;

    public Cake(String decorations) {
        this.decorations = decorations;
    }

    public Cake decorate(String decoration) {
        return new Cake(getDecorations() + decoration);
    }

    public String getDecorations() {
        return decorations;
    }
}
```

The climax here is the `decorate()` method. Mainly, this method applies the given decoration next to the existing decorations and returns a new `Cake`.

As another example, let's consider the `java.awt.Color` class, which has a method named `brighter()`. This method creates a new `Color` that is a brighter version of the current `Color`. Similarly, the `decorate()` method creates a new `Cake` that is a more decorated version of the current `Cake`.

Furthermore, there is no need to write decorators as separate classes. We will rely on lambdas to pass the decorators to the `CakeDecorator`:

```
public class CakeDecorator {

    private Function<Cake, Cake> decorator;

    public CakeDecorator(Function<Cake, Cake>... decorations) {
        reduceDecorations(decorations);
    }

    public Cake decorate(Cake cake) {
        return decorator.apply(cake);
    }

    private void reduceDecorations(
        Function<Cake, Cake>... decorations) {

        decorator = Stream.of(decorations)
            .reduce(Function.identity(), Function::andThen);
    }
}
```

Mainly, this class accomplishes two things:

- In the constructor, it calls the `reduceDecorations()` method. This method will chain the array of the passed `Function` via the `Stream.reduce()` and `Function.andThen()` methods. The result is a single `Function` composed from the array of the given `Function`.
- When the `apply()` method of the composed `Function` is called from the `decorate()` method, it will apply the chain of given functions one by one. Since each `Function` in the given array is a decorator, the composed `Function` will apply each decorator one by one.

Let's create a Cake decorated with nuts and cream:

```
CakeDecorator nutsAndCream = new CakeDecorator(
    (Cake c) -> c.decorate(" with Nuts"),
    (Cake c) -> c.decorate(" with Cream"));

Cake cake = nutsAndCream.decorate(new Cake("Base cake"));

// Base cake with Nuts with Cream
System.out.println(cake.getDecorations());
```

Done! Consider running the code bundled with this book to check the output.

175. Implementing the Cascaded Builder pattern

We already talked about this pattern in [Chapter 2, Objects, Immutability, and Switch Expressions](#), in the *Writing an immutable class via the Builder pattern* section. It is advisable to treat this problem, just as a quick reminder of the Builder pattern.

Having the classic Builder under our tool belt, let's suppose that we want to write a class for delivering parcels. Mainly, we want to set the receiver's first name, last name, address, and parcel content and then deliver the parcel.

We can accomplish this via the Builder pattern and lambdas, as follows:

```
public final class Delivery {

    public Delivery firstname(String firstname) {
        System.out.println(firstname);

        return this;
    }

    //similar for lastname, address and content

    public static void deliver(Consumer<Delivery> parcel) {
        Delivery delivery = new Delivery();
        parcel.accept(delivery);

        System.out.println("\nDone ...");
    }
}
```

For delivering a parcel, we simply use a lambda:

```
Delivery.deliver(d -> d.firstname("Mark")
    .lastname("Kyilt")
    .address("25 Street, New York")
    .content("10 books"));
```

Obviously, using lambdas is facilitated by the `Consumer<Delivery>` argument.

176. Implementing the Command pattern

In a nutshell, the Command pattern is used in scenarios where a command is wrapped in an object. This object can be passed around without being aware of the command itself or the receiver of the command.

A classic implementation of this pattern consists of several classes. In our scenario, we have the following:

- The `Command` interface is responsible for executing a certain action (in this case, the possible actions are `move`, `copy`, and `delete`). The concrete implementations of this interface are `CopyCommand`, `MoveCommand`, and `DeleteCommand`.
- The `IODevice` interface defines the supported actions (`move()`, `copy()`, and `delete()`). The `HardDisk` class is a concrete implementation of `IODevice` and represents the *receiver*.
- The `Sequence` class is the *invoker* of the commands, and it knows how to execute a given command. The *invoker* can act in different ways, but in this case, we simply record the commands and execute them in a batch when the `runSequence()` is called.

The Command pattern can be represented by the following diagram:

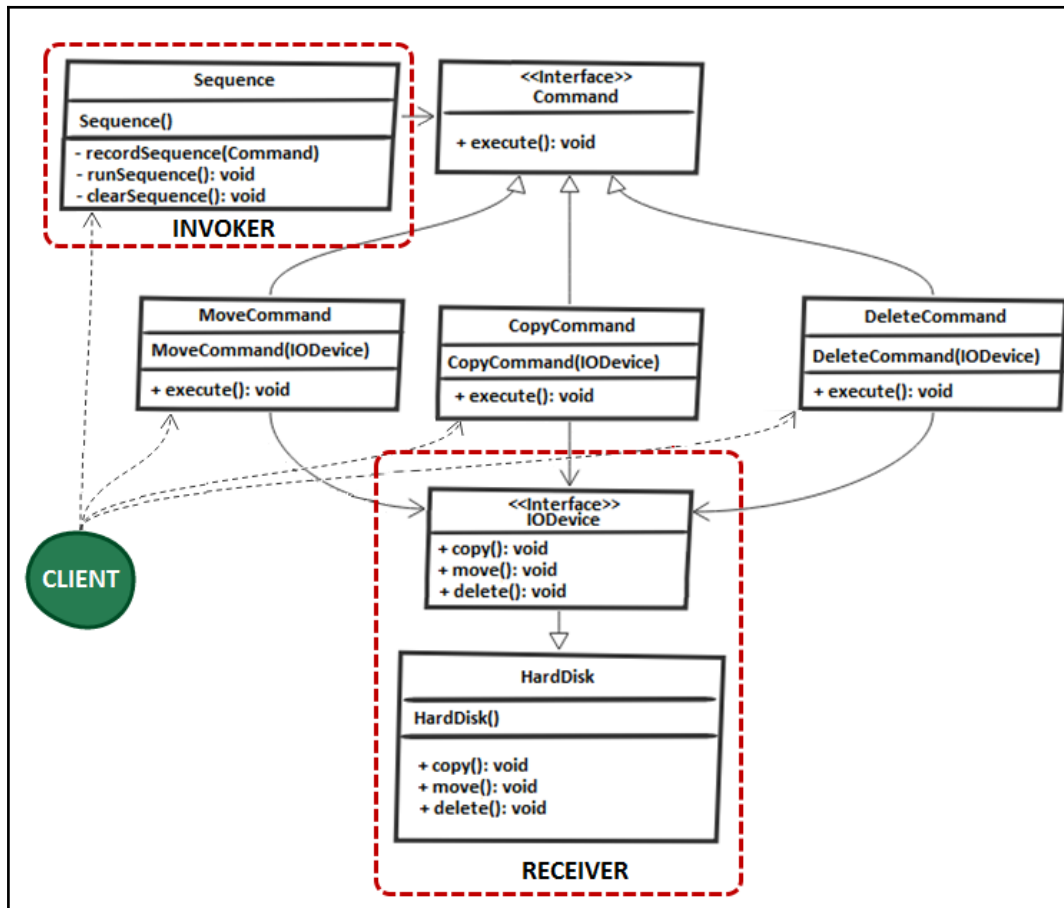

So, the `HardDisk` implements the actions that are given in the `IODevice` interface. As a *receiver*, the `HardDisk` is responsible for running the actual action when the `execute()` method of a certain command is called. The source code for `IODevice` is as follows:

```

public interface IODevice {
    void copy();
    void delete();
    void move();
}
  
```

The `HardDisk` is the concrete implementation of `IODevice`:

```
public class HardDisk implements IODevice {

    @Override
    public void copy() {
        System.out.println("Copying ...");
    }

    @Override
    public void delete() {
        System.out.println("Deleting ...");
    }

    @Override
    public void move() {
        System.out.println("Moving ...");
    }
}
```

All concrete command classes implement the `Command` interface:

```
public interface Command {
    public void execute();
}

public class DeleteCommand implements Command {

    private final IODevice action;

    public DeleteCommand(IODevice action) {
        this.action = action;
    }

    @Override
    public void execute() {
        action.delete()
    }
}
```

In the same manner, we have implemented `CopyCommand` and `MoveCommand` and skipped these for brevity purposes.

Furthermore, the `Sequence` class acts as the *invoker* class. The *invoker* knows how to execute the given command, but it doesn't have any clue about the command's implementation (it only knows the command's interface). Here, we record the commands in a `List` and execute those commands in a batch when the `runSequence()` method is called:

```
public class Sequence {  
  
    private final List<Command> commands = new ArrayList<>();  
  
    public void recordSequence(Command cmd) {  
        commands.add(cmd);  
    }  
  
    public void runSequence() {  
        commands.forEach(Command::execute);  
    }  
  
    public void clearSequence() {  
        commands.clear();  
    }  
}
```

Now, let's see it at work. Let's execute a batch of actions on `HardDisk`:

```
HardDisk hd = new HardDisk();  
Sequence sequence = new Sequence();  
sequence.recordSequence(new CopyCommand(hd));  
sequence.recordSequence(new DeleteCommand(hd));  
sequence.recordSequence(new MoveCommand(hd));  
sequence.recordSequence(new DeleteCommand(hd));  
sequence.runSequence();
```

Obviously, we have a lot of *boilerplate* code here. Check out the classes of commands. Do we actually need all of these classes? Well, if we realize that the `Command` interface is actually a functional interface, then we can remove its implementations and provide the behaviors via lambdas (the command classes are just blocks of behavior, and so they can be expressed via lambdas), as follows:

```
HardDisk hd = new HardDisk();  
Sequence sequence = new Sequence();  
sequence.recordSequence(hd::copy);  
sequence.recordSequence(hd::delete);  
sequence.recordSequence(hd::move);  
sequence.recordSequence(hd::delete);  
sequence.runSequence();
```

Summary

We have now reached the end of this chapter. Using lambdas to reduce or even eliminate the *boilerplate* code is a technique that can be used in other design patterns and scenarios as well. Having the knowledge you've accumulated so far should provide you with a solid base for adapting your cases accordingly.

Download the applications from this chapter to view the results and additional details.

9

Functional Style Programming - a Deep Dive

This chapter includes 22 problems that involve Java functional-style programming. Here, we will focus on several problems that involve classical operations that are encountered in streams (such as `filter` and `map`), and discuss infinite streams, null-safe streams, and default methods. This comprehensive list of problems will cover grouping, partitioning, and collectors, including the JDK 12 `teeing()` collector and writing a custom collector. In addition, `takeWhile()`, `dropWhile()`, composing functions, predicates and comparators, testing and debugging lambdas, and other cool topics will be discussed as well.

Once you've covered this and the previous chapter, you will be ready to unleash functional-style programming on your production applications. The following problems will prepare you for a wide range of use cases, including corner cases or pitfalls.

Problems

Use the following problems to test your functional style programming prowess. I strongly encourage you to give each problem a try before you turn to the solutions and download the example programs:

177. **Testing high-order functions:** Write several unit tests for testing so-called high-order functions.
178. **Testing methods that use lambdas:** Write several unit tests for testing methods that use lambdas.
179. **Debugging lambdas:** Provide a technique for debugging lambdas.
180. **Filtering the non-zero elements of a stream:** Write a stream pipeline that filters the non-zero elements of a stream.

181. **Infinite streams**, `takeWhile()`, and `dropWhile()`: Write several snippets of code that work with infinite streams. In addition, write several examples of working with the `takeWhile()` and `dropWhile()` APIs.
182. **Mapping a stream**: Write several examples of mapping a stream via `map()` and `flatMap()`.
183. **Finding different elements in a stream**: Write a program for finding different elements in a stream.
184. **Matching different elements in a stream**: Write a program for matching different elements in a stream.
185. **Sum, max, and min in a stream**: Write a program for computing the sum, max, and min of the given stream via primitive specializations of `Stream` and `Stream.reduce()`.
186. **Collecting the results of a stream**: Write several snippets of code for collecting the results of a stream in a list, map, and set.
187. **Joining the results of a stream**: Write several snippets of code for joining the results of a stream into a `String`.
188. **Summarization collectors**: Write several snippets of code to reveal the usage of summarization collectors.
189. **Grouping**: Write snippets of code for working with `groupingBy()` collectors.
190. **Partitioning**: Write several snippets of code for working with `partitioningBy()` collectors.
191. **Filtering, flattening, and mapping collectors**: Write several snippets of code for exemplifying the usage of filtering, flattening, and mapping collectors.
192. **Teeing**: Write several examples that merge the results of two collectors (JDK 12 and `Collectors.teeing()`).
193. **Writing a custom collector**: Write a program that represents a custom collector.
194. **Method reference**: Write an example of method reference.
195. **Parallel processing of streams**: Provide a brief overview of the parallel processing of streams. Provide at least one example each for `parallelStream()`, `parallel()`, and `splitter()`.
196. **Null-safe streams**: Write a program that returns a null-safe stream from an element or a collection of elements.
197. **Composing functions, predicates, and comparators**: Write several examples for composing functions, predicates, and comparators.
198. **Default methods**: Write an interface that contains a `default` method.

Solutions

The following sections describe the solutions to the preceding problems. Remember that there usually isn't a single correct way to solve a particular problem. Also, remember that the explanations shown here only include the most interesting and important details that are needed to solve the problems. You can download the example solutions to view additional details and experiment with the programs from <https://github.com/PacktPublishing/Java-Coding-Problems>.

177. Testing high-order functions

A *high-order function* is a term that's used to characterize a function that returns a function or takes a function as a parameter.

Based on this statement, testing a high-order function in the context of lambdas should cover two main cases:

- Testing a method that takes a lambda as a parameter
- Testing a method that returns a functional interface

We'll learn about these two tests in the upcoming sections.

Testing a method that takes a lambda as a parameter

Testing a method that takes a lambda as a parameter can be accomplished by passing different lambdas to this method. For example, let's assume that we have the following functional interface:

```
@FunctionalInterface
public interface Replacer<String> {
    String replace(String s);
}
```

Let's also assume that we have a method that takes lambdas of the `String -> String` type, as follows:

```
public static List<String> replace(
    List<String> list, Replacer<String> r) {

    List<String> result = new ArrayList<>();
    for (String s: list) {
```

```
        result.add(r.replace(s));
    }

    return result;
}
```

Now, let's write a JUnit test for this method using two lambdas:

```
@Test
public void testReplacer() throws Exception {

    List<String> names = Arrays.asList(
        "Ann a 15", "Mir el 28", "D oru 33");

    List<String> resultWs = replace(
        names, (String s) -> s.replaceAll("\\s", ""));
    List<String> resultNr = replace(
        names, (String s) -> s.replaceAll("\\d", ""));

    assertEquals(Arrays.asList(
        "Anna15", "Mirel28", "Doru33"), resultWs);
    assertEquals(Arrays.asList(
        "Ann a ", "Mir el ", "D oru "), resultNr);
}
```

Testing a method that returns a functional interface

On the other hand, testing a method that returns a functional interface can be interpreted as testing the behavior of that functional interface. Let's consider the following method:

```
public static Function<String, String> reduceStrings(
    Function<String, String> ...functions) {

    Function<String, String> function = Stream.of(functions)
        .reduce(Function.identity(), Function::andThen);

    return function;
}
```

Now, we can test the behavior of the returned `Function<String, String>` as follows:

```
@Test
public void testReduceStrings() throws Exception {

    Function<String, String> f1 = (String s) -> s.toUpperCase();
```

```
Function<String, String> f2 = (String s) -> s.concat(" DONE");

Function<String, String> f = reduceStrings(f1, f2);

assertEquals("TEST DONE", f.apply("test"));
}
```

178. Testing methods that use lambdas

Let's start by testing a lambda that is not wrapped in a method. For example, the following lambda is associated with a field (for being reused), and we want to test its logic:

```
public static final Function<String, String> firstAndLastChar
    = (String s) -> String.valueOf(s.charAt(0))
      + String.valueOf(s.charAt(s.length() - 1));
```

Let's take into account that a lambda generates an instance of a functional interface; then, we can test the behavior of that instance as follows:

```
@Test
public void testFirstAndLastChar() throws Exception {

    String text = "Lambda";
    String result = firstAndLastChar.apply(text);
    assertEquals("La", result);
}
```



Another solution consists of wrapping the lambda in a method call and writing unit tests for the method call.

Often, the lambdas are used inside methods. For most cases, testing the method that contains the lambda is acceptable, but there are cases when we want to test the lambda itself. A solution to this problem consists of three main steps:

1. Extracting the lambda in a *static* method
2. Replacing the lambda with a *method reference*
3. Testing this *static* method

For example, let's consider the following method:

```
public List<String> rndStringFromStrings(List<String> str) {  
  
    return str.stream()  
        .map(str -> {  
            Random rnd = new Random();  
            int nr = rnd.nextInt(str.length());  
            String ch = String.valueOf(str.charAt(nr));  
  
            return ch;  
        })  
        .collect(Collectors.toList());  
}
```

Our goal is to test the lambda from this method:

```
str -> {  
    Random rnd = new Random();  
    int nr = rnd.nextInt(str.length());  
    String ch = String.valueOf(str.charAt(nr));  
  
    return ch;  
}
```

So, let's apply the preceding three steps:

1. Let's extract this lambda in a static method:

```
public static String extractCharacter(String str) {  
  
    Random rnd = new Random();  
    int nr = rnd.nextInt(str.length());  
    String chAsStr = String.valueOf(str.charAt(nr));  
  
    return chAsStr;  
}
```

2. Let's replace the lambda with the corresponding method reference:

```
public List<String> rndStringFromStrings(List<String> str) {  
  
    return str.stream()  
        .map(StringOperations::extractCharacter)  
        .collect(Collectors.toList());  
}
```

3. Let's test the static method (which is the lambda):

```
@Test
public void testRndStringFromStrings() throws Exception {

    String str1 = "Some";
    String str2 = "random";
    String str3 = "text";

    String result1 = extractCharacter(str1);
    String result2 = extractCharacter(str2);
    String result3 = extractCharacter(str3);

    assertEquals(result1.length(), 1);
    assertEquals(result2.length(), 1);
    assertEquals(result3.length(), 1);
    assertThat(str1, containsString(result1));
    assertThat(str2, containsString(result2));
    assertThat(str3, containsString(result3));
}
```



It is advisable to avoid lambdas that have more than one line of code. Therefore, by following the preceding technique, the lambdas become easy to test.

179. Debugging lambdas

There are at least three solutions when it comes to debugging lambdas:

- Inspect a stack trace
- Logging
- Rely on IDE support (for example, NetBeans, Eclipse, and IntelliJ IDEA support debugging lambdas *out of the box* or provide plugins for it)

Let's focus on the first two since relying on an IDE is a very large and specific topic that isn't in the scope of this book.

Inspecting the stack trace of a failure that happened inside a lambda or a stream pipeline can be pretty puzzling. Let's consider the following snippet of code:

```
List<String> names = Arrays.asList("anna", "bob", null, "mary");

names.stream()
    .map(s -> s.toUpperCase())
    .collect(Collectors.toList());
```

Since the third element from this list is null, we will get a `NullPointerException`, and the whole sequence of calls that defines the stream pipeline is exposed, as in the following screenshot:

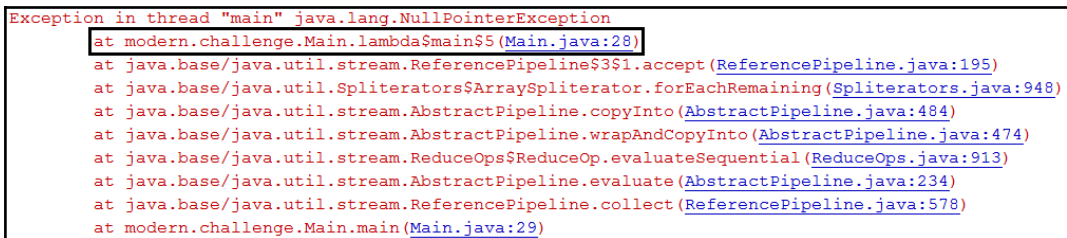

```
Exception in thread "main" java.lang.NullPointerException
    at modern.challenge.Main.lambda$main$5(Main.java:28)
    at java.base/java.util.stream.ReferencePipeline$3$1.accept(ReferencePipeline.java:195)
    at java.base/java.util.Spliterators$ArraySpliterator.forEachRemaining(Spliterators.java:948)
    at java.base/java.util.stream.AbstractPipeline.copyInto(AbstractPipeline.java:484)
    at java.base/java.util.stream.AbstractPipeline.wrapAndCopyInto(AbstractPipeline.java:474)
    at java.base/java.util.stream.ReduceOps$ReduceOp.evaluateSequential(ReduceOps.java:913)
    at java.base/java.util.stream.AbstractPipeline.evaluate(AbstractPipeline.java:234)
    at java.base/java.util.stream.ReferencePipeline.collect(ReferencePipeline.java:578)
    at modern.challenge.Main.main(Main.java:29)
```

The highlighted line tells us that this `NullPointerException` has occurred inside a lambda expression named `lambda$main$5`. This name was made up by the compiler since lambdas don't have names. Moreover, we don't know which element was null.

So, we can conclude that a stack trace that reports a failure inside a lambda or stream pipeline is not very intuitive.

Alternatively, we can try to log the output. This will help us debug a pipeline of operations in a stream. This can be accomplished via the `forEach()` method:

```
List<String> list = List.of("anna", "bob",
    "christian", "carmen", "rick", "carla");

list.stream()
    .filter(s -> s.startsWith("c"))
    .map(String::toUpperCase)
    .sorted()
    .forEach(System.out::println);
```

This will give us the following output:

```
CARLA  
CARMEN  
CHRISTIAN
```

In some cases, this technique can be useful. Of course, we have to keep in mind that `forEach()` is a terminal operation, and so the stream will be consumed. Since a stream can only be consumed once, this can be an issue.

Moreover, if we add a `null` value to the list, then the output will become confusing again.

A better alternative consists of relying on the `peek()` method. This is an intermediate operation that executes a certain action on the current element and forwards the element to the next operation in the pipeline. The following diagram shows the `peek()` operation at work:

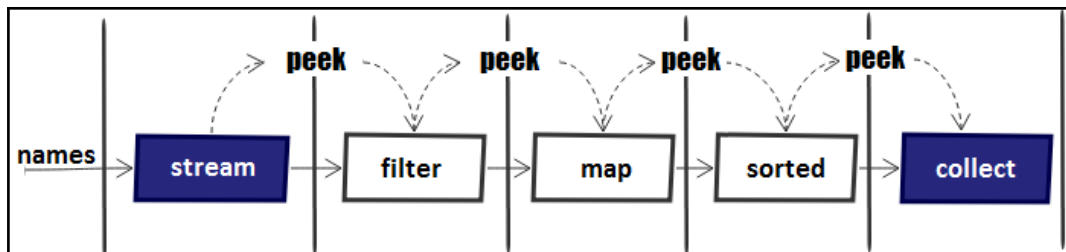

Let's see it in code form:

```
System.out.println("After:");  
  
names.stream()  
    .peek(p -> System.out.println("\tstream(): " + p))  
    .filter(s -> s.startsWith("c"))  
    .peek(p -> System.out.println("\tfilter(): " + p))  
    .map(String::toUpperCase)  
    .peek(p -> System.out.println("\tmap(): " + p))  
    .sorted()  
    .peek(p -> System.out.println("\tsorted(): " + p))  
    .collect(Collectors.toList());
```

The following is an example of the output we may receive:

```
After:
    stream(): anna
    stream(): bob
    stream(): christian
    filter(): christian
    map(): CHRISTIAN
    stream(): carmen
    filter(): carmen
    map(): CARMEN
    stream(): rick
    stream(): carla
    filter(): carla
    map(): CARLA
    sorted(): CARLA
    sorted(): CARMEN
    sorted(): CHRISTIAN
```

Now, let's intentionally add a null value to the list and run it again:

```
List<String> names = Arrays.asList("anna", "bob",
    "christian", null, "carmen", "rick", "carla");
```

The following output was obtained after adding a null value to the list:

```
After:
    stream(): anna
    stream(): bob
    stream(): christian
    filter(): christian
    map(): CHRISTIAN
    stream(): null
Exception in thread "main" java.lang.NullPointerException
    at modern.challenge.Main.lambda$main$1(Main.java:16)
    ...
```

This time, we can see that a null value occurred after applying `stream()`. Since `stream()` is the first operation, we can easily figure out that the error resides in the list content.

180. Filtering the non-zero elements of a stream

In Chapter 8, *Functional Style Programming – Fundamentals and Design Patterns*, in the *Writing functional interfaces* section, we defined a `filter()` method based on a functional interface named `Predicate`. The Java Stream API already has such a method, and the functional interface is called `java.util.function.Predicate`.

Let's assume that we have the following `List` of integers:

```
List<Integer> ints = Arrays.asList(1, 2, -4, 0, 2, 0, -1, 14, 0, -1);
```

Streaming this list and extracting only non-zero elements can be accomplished as follows:

```
List<Integer> result = ints.stream()
    .filter(i -> i != 0)
    .collect(Collectors.toList());
```

The resulting list will contain the following elements: 1, 2, -4, 2, -1, 14, -1

The following diagram shows how `filter()` works internally:

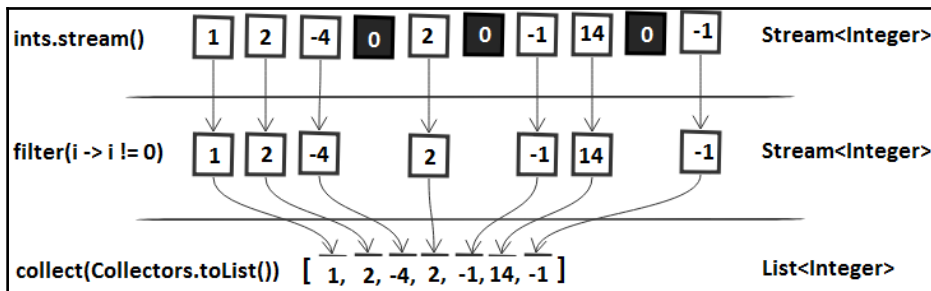

Notice that, for several common operations, the Java Stream API already provides *out of the box* intermediate operations. Hence, there is no need to provide a `Predicate`. Some of these operations are as follows:

- `distinct()`: Removes duplicates from the stream
- `skip(n)`: Discards the first n elements
- `limit(s)`: Truncates the stream to be no longer than s in length

- `sorted()`: Sorts the stream according to the natural order
- `sorted(Comparator<? super T> comparator)`: Sorts the stream according to the given `Comparator`

Let's add these operations and a `filter()` to an example. We will filter zeros, filter duplicates, skip 1 value, truncate the remaining stream to two elements, and sort them by their natural order:

```
List<Integer> result = ints.stream()
    .filter(i -> i != 0)
    .distinct()
    .skip(1)
    .limit(2)
    .sorted()
    .collect(Collectors.toList());
```

The resulting list will contain the following two elements: **-4** and **2**.

The following diagram shows how this stream pipeline works internally:

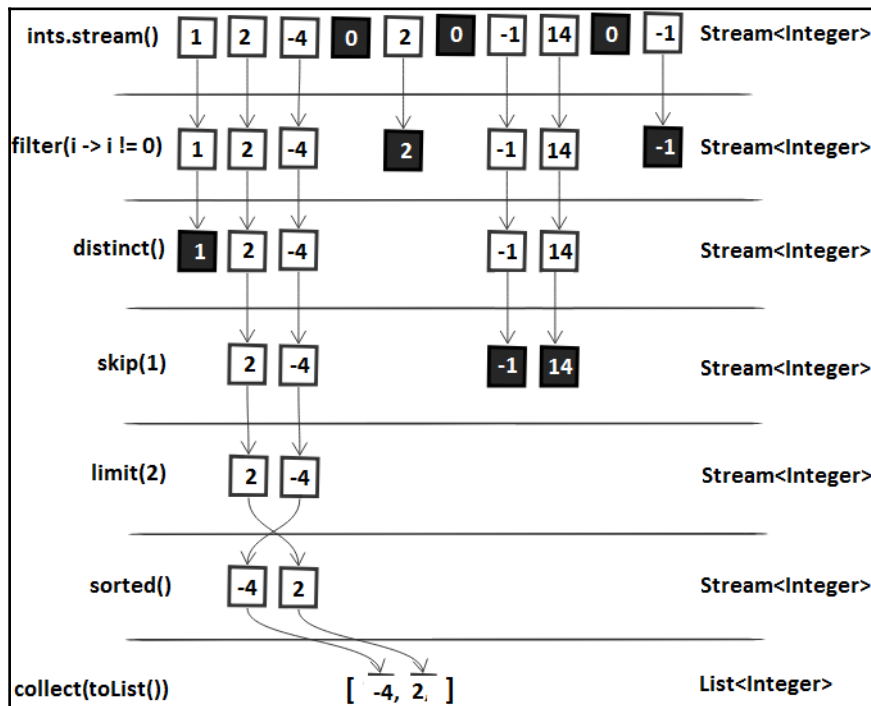

When the `filter()` operation needs a complex/compound or long condition, then it is advisable to extract it in an ancillary static method and rely on *method references*. Therefore, avoid something like this:

```
List<Integer> result = ints.stream()
    .filter(value -> value > 0 && value < 10 && value % 2 == 0)
    .collect(Collectors.toList());
```

You should prefer something like this (`Numbers` is the class containing the ancillary method):

```
List<Integer> result = ints.stream()
    .filter(Numbers::evenBetween0And10)
    .collect(Collectors.toList());

private static boolean evenBetween0And10(int value) {
    return value > 0 && value < 10 && value % 2 == 0;
}
```

181. Infinite streams, `takeWhile()`, and `dropWhile()`

In the first part of this problem, we will talk about infinite streams. In the second part, we will talk about the `takeWhile()` and `dropWhile()` APIs.

An infinite stream is a stream that creates data indefinitely. Because streams are lazy, they can be infinite. More precisely, creating an infinite stream is accomplished as an intermediate operation, and so no data is created until a terminal operation of the pipeline is executed.

For example, the following code will theoretically run forever. This behavior is triggered by the `forEach()` terminal operation and caused by a missing constraint or limitation:

```
Stream.iterate(1, i -> i + 1)
    .forEach(System.out::println);
```

The Java Stream API allows us to create and manipulate an infinite stream in several ways, as you will see shortly.

Moreover, a `Stream` can be *ordered* or *unordered*, depending on the defined *encounter order*. Whether or not a stream has an *encounter order* depends on the source of data and the intermediate operations. For example, a `Stream` that has a `List` as its source is ordered because `List` has an intrinsic ordering. On the other hand, a `Stream` that has a `Set` as its source is unordered because `Set` doesn't guarantee order. Some intermediate operations (for example, `sorted()`) may impose an order to an unordered `Stream`, while some terminal operations (for example, `forEach()`) may ignore the encounter order.



Commonly, the performance of sequential streams is insignificantly affected by ordering, but depending on the applied operations, the performance of parallel streams may be significantly affected by the presence of an ordered `Stream`.

Don't confuse `Collection.stream().forEach()` with `Collection.forEach()`. While `Collection.forEach()` can keep order by relying on the collection's iterator (if any), the `Collection.stream().forEach()` order undefined. For example, iterating a `List` several times via `list.forEach()` processes the elements in insertion order, while `list.parallelStream().forEach()` produces a different result at each run. As a rule of thumb, if a stream is not needed, then iterate over a collection via `Collection.forEach()`.

We can turn an ordered stream into an unordered stream via `BaseStream.unordered()`, as shown in the following example:

```
List<Integer> list
    = Arrays.asList(1, 4, 20, 15, 2, 17, 5, 22, 31, 16);

Stream<Integer> unorderedStream = list.stream()
    .unordered();
```

Infinite sequential ordered stream

An infinite sequential ordered stream can be obtained via `Stream.iterate(T seed, UnaryOperator<T> f)`. The resulting stream starts from the specified seed and continues by applying the `f` function to the previous element (for example, the `n` element is `f(n-1)`).

For example, a stream of integers of type `1, 2, 3, ..., n` can be created as follows:

```
Stream<Integer> infStream = Stream.iterate(1, i -> i + 1);
```

Furthermore, we can use this stream for a variety of purposes. For example, let's use it to fetch a list of the first 10 even integers:

```
List<Integer> result = infStream
    .filter(i -> i % 2 == 0)
    .limit(10)
    .collect(Collectors.toList());
```

The `List` content will be as follows (notice that the infinite stream will create the elements 1, 2, 3, ..., 20, but only the following elements are matching our filter until the limit of 10 elements is reached):

```
2, 4, 6, 8, 10, 12, 14, 16, 18, 20
```



Notice the presence of the `limit()` intermediate operation. Its presence is mandatory; otherwise, the code will run indefinitely. We must explicitly discard the stream; in other words, we must explicitly specify how many elements that match our filter should be collected in the final list. Once the limit has been reached, the infinite stream is discarded.

But let's assume that we don't want the list of the first 10 even integers, and we actually want the list of even integers until 10 (or any other limit). Starting with JDK 9, we can shape this behavior via a new flavor of `Stream.iterate()`. This flavor allows us to embed a `hasNext` predicate directly into the stream declaration (`iterate(T seed, Predicate<? super T> hasNext, UnaryOperator<T> next)`). The stream terminates as soon as the `hasNext` predicate returns `false`:

```
Stream<Integer> infStream = Stream.iterate(
    1, i -> i <= 10, i -> i + 1);
```

This time, we can remove the `limit()` intermediate operation since our `hasNext` predicate imposes the limit of 10 elements:

```
List<Integer> result = infStream
    .filter(i -> i % 2 == 0)
    .collect(Collectors.toList());
```

The resulting `List` is as follows (conforming to our `hasNext` predicate, the infinite stream creates the elements 1, 2, 3, ..., 10, but only the following five elements match our stream filter):

```
2, 4, 6, 8, 10
```

Of course, we can combine this flavor of `Stream.iterate()` and `limit()` to shape more complex scenarios. For example, the following stream will create new element until the *have next* predicate, `i -> i <= 10`. Since we are using random values, the moment when the `hasNext` predicate will return `false` is nondeterministic:

```
Stream<Integer> infStream = Stream.iterate(
    1, i -> i <= 10, i -> i + i % 2 == 0
    ? new Random().nextInt(20) : -1 * new Random().nextInt(10));
```

One possible output for this stream is as follows:

```
1, -5, -4, -7, -4, -2, -8, -8, ..., 3, 0, 4, -7, -6, 10, ...
```

Now, the following pipeline will collect a maximum of 25 numbers that were created via `infStream`:

```
List<Integer> result = infStream
    .limit(25)
    .collect(Collectors.toList());
```

Now, the infinite stream can be discarded from two places. If the `hasNext` predicate returns `false` until we collect 25 elements, then we remain with the collected elements at that moment (less than 25). If the `hasNext` predicate doesn't return `false` until we collect 25 elements, then the `limit()` operation will discard the rest of the stream.

Unlimited stream of pseudorandom values

If we want to create unlimited streams of pseudorandom values, we can rely on the methods of `Random`, such as `ints()`, `longs()`, and `doubles()`. For example, an unlimited stream of pseudorandom integer values can be declared as follows (the generated integers will be in the `[1, 100]` range):

```
IntStream rndInfStream = new Random().ints(1, 100);
```

Trying to fetch a list of 10 even pseudorandom integer values can rely on this stream:

```
List<Integer> result = rndInfStream
    .filter(i -> i % 2 == 0)
    .limit(10)
    .boxed()
    .collect(Collectors.toList());
```

One possible output is as follows:

```
8, 24, 82, 42, 90, 18, 26, 96, 86, 86
```

This time, it is harder to say how many numbers were actually generated until the aforementioned list is collected.

Another flavor of `ints()` is `ints(long streamSize, int randomNumberOrigin, int randomNumberBound)`. The first argument allows us to specify how many pseudorandom values should be generated. For example, the following stream will generate exactly 10 values in the range of [1, 100]:

```
IntStream rndInfStream = new Random().ints(10, 1, 100);
```

We can fetch the even values from these 10, as follows:

```
List<Integer> result = rndInfStream
    .filter(i -> i % 2 == 0)
    .boxed()
    .collect(Collectors.toList());
```

One possible output is as follows:

```
80, 28, 60, 54
```

We can use this example as a base for generating random strings of a fixed length, as follows:

```
IntStream rndInfStream = new Random().ints(20, 48, 126);
String result = rndInfStream
    .mapToObj(n -> String.valueOf((char) n))
    .collect(Collectors.joining());
```

One possible output is as follows:

```
AIW?F1obl3KPKMItqY8>
```



`Stream.ints()` comes with two more flavors: one that doesn't take any argument (an unlimited stream of integers) and another that takes a single argument representing the number of values that should be generated, that is, `ints(long streamSize)`.

Infinite sequential unordered stream

In order to create an infinite sequential unordered stream, we can rely on `Stream.generate(Supplier<? extends T> s)`. In this case, each element is generated by the provided `Supplier`. This is suitable for generating constant streams, streams of random elements, and so on.

For example, let's assume that we have a simple helper that generates passwords of eight characters:

```
private static String randomPassword() {  
  
    String chars = "abcd0123!@#\$";  
  
    return new SecureRandom().ints(8, 0, chars.length())  
        .mapToObj(i -> String.valueOf(chars.charAt(i)))  
        .collect(Collectors.joining());  
}
```

Furthermore, we want to define an infinite sequential unordered stream that returns random passwords (`Main` is the class that contains the preceding helper):

```
Supplier<String> passwordSupplier = Main::randomPassword;  
Stream<String> passwordStream = Stream.generate(passwordSupplier);
```

At this point, `passwordStream` can create passwords indefinitely. But let's create 10 such passwords:

```
List<String> result = passwordStream  
    .limit(10)  
    .collect(Collectors.toList());
```

One possible output is as follows:

```
213c1b1c, 2badc$21, d33321d$, @a0dc323, 3!1aa!dc, 0a3##@3!, $!b2#1d@,  
0@0#dd$, cb$12d2@, d2@cc@d
```

Take while a predicate returns true

One of the most useful methods that was added to the `Stream` class, starting with JDK 9, was `takeWhile(Predicate<? super T> predicate)`. This method comes with two different behaviors, as follows:

- If the stream is ordered, it returns a stream consisting of the *longest prefix of elements* taken from this stream that match the given predicate.

- If the stream is unordered, and some (but not all) of the elements of this stream match the given predicate, then the behavior of this operation is nondeterministic; it is free to take any subset of matching elements (which includes the empty set).

In the case of an ordered `Stream`, the *longest prefix of elements* is a contiguous sequence of elements of the stream that match with the given predicate.



Note that `takeWhile()` will discard the remaining stream once the given predicate returns `false`.

For example, fetching a list of 10 integers can be done as follows:

```
List<Integer> result = IntStream
    .iterate(1, i -> i + 1)
    .takeWhile(i -> i <= 10)
    .boxed()
    .collect(Collectors.toList());
```

This will give us the following output:

```
1, 2, 3, 4, 5, 6, 7, 8, 9, 10
```

Alternatively, we could fetch a `List` of random even integers until the first generated value is less than 50:

```
List<Integer> result = new Random().ints(1, 100)
    .filter(i -> i % 2 == 0)
    .takeWhile(i -> i >= 50)
    .boxed()
    .collect(Collectors.toList());
```

We can even join the predicates in `takeWhile()`:

```
List<Integer> result = new Random().ints(1, 100)
    .takeWhile(i -> i % 2 == 0 && i >= 50)
    .boxed()
    .collect(Collectors.toList());
```

One possible output can be obtained as follows (it can be empty as well):

```
64, 76, 54, 68
```

How about fetching a `List` of random passwords until the first generated password doesn't contain the `!` character?

Well, based on the helper we listed earlier, we can do this like so:

```
List<String> result = Stream.generate(Main::randomPassword)
    .takeWhile(s -> s.contains("!"))
    .collect(Collectors.toList());
```

One possible output can be obtained as follows (it can be empty as well):

```
0!dac!3c, 2!$!b2ac, 1d12ba1!
```

Now, let's assume that we have an unordered stream of integers. The following snippet of code takes a subset of elements that are less than or equal to 10:

```
Set<Integer> setOfInts = new HashSet<>(
    Arrays.asList(1, 4, 3, 52, 9, 40, 5, 2, 31, 8));

List<Integer> result = setOfInts.stream()
    .takeWhile(i -> i <= 10)
    .collect(Collectors.toList());
```

One possible output is as follows (remember that, for an unordered stream, the result is nondeterministic):

```
1, 3, 4
```

Drop while a predicate returns true

Starting with JDK 9, we also have the `Stream.dropWhile(Predicate<? super T> predicate)` method. This method is the opposite of `takeWhile()`. Instead of taking elements until the given predicate returns `false`, this method drops the elements until the given element returns `false` and includes the rest of the elements in the returned stream:

- If the stream is ordered, it returns a stream consisting of the remaining elements of this stream after dropping the *longest prefix of elements* that match the given predicate.
- If the stream is unordered, and some (but not all) of the elements of this stream match the given predicate, then the behavior of this operation is nondeterministic; it is free to drop any subset of matching elements (which includes the empty set).

In the case of an ordered `Stream`, the *longest prefix of elements* is a contiguous sequence of elements of the stream that match the given predicate.

For example, let's collect 5 integers after dropping the first 10:

```
List<Integer> result = IntStream
    .iterate(1, i -> i + 1)
    .dropWhile(i -> i <= 10)
    .limit(5)
    .boxed()
    .collect(Collectors.toList());
```

This will always give the following output:

```
11, 12, 13, 14, 15
```

Alternatively, we can fetch a `List` of five random even integers greater than 50 (at least, this is what we may think the code does):

```
List<Integer> result = new Random().ints(1, 100)
    .filter(i -> i % 2 == 0)
    .dropWhile(i -> i < 50)
    .limit(5)
    .boxed()
    .collect(Collectors.toList());
```

One possible output is as follows:

```
78, 16, 4, 94, 26
```

But why is 16 and 4 there? They are even, but not greater than 50! Well, they are there because they came after the first element, which failed the predicate. Mainly, we are dropping values while they are smaller than 50 (`dropWhile(i -> i < 50)`). The 78 value will fail this predicate, so `dropWhile` ends its job. Furthermore, all the generated elements are included in the result until `limit(5)` takes action.

Let's look at another similar trap. Let's fetch a `List` of five random passwords containing the `!` character (at least, this is what we may think the code does):

```
List<String> result = Stream.generate(Main::randomPassword)
    .dropWhile(s -> !s.contains("!"))
    .limit(5)
    .collect(Collectors.toList());
```

One possible output is as follows:

```
bab2!3dd, c2@$1acc, $c1c@cb@, !b21$cdc, #b103c21
```

Again, we can see passwords that don't contain the ! character. The `bab2!3dd` password will fail our predicate and will end up in the final result (`List`). The four generated passwords are added to the result without being influenced by `dropWhile()`.

Now, let's assume that we have an unordered stream of integers. The following snippet of code drops a subset of elements that are less than or equal to 10 and keeps the rest:

```
Set<Integer> setOfInts = new HashSet<>(
    Arrays.asList(5, 42, 3, 2, 11, 1, 6, 55, 9, 7));

List<Integer> result = setOfInts.stream()
    .dropWhile(i -> i <= 10)
    .collect(Collectors.toList());
```

One possible output is as follows (remember that, for an unordered stream, the result is nondeterministic):

```
55, 7, 9, 42, 11
```

If all the elements match the given predicate, then `takeWhile()` takes and `dropWhile()` drops all elements (it doesn't matter if the stream is ordered or unordered). On the other hand, if none of the elements match the given predicate, then `takeWhile()` takes nothing (returns an empty stream) and `dropWhile()` drops nothing (returns the stream).



Avoid using `take/dropWhile()` in the context of parallel streams since they are expensive operations, especially for ordered streams. If it is suitable for the case, then just remove the ordering constraint via `BaseStream.unordered()`.

182. Mapping the elements of a stream

Mapping the elements of a stream is an intermediate operation that's used for *transforming* these elements into a new version of them by applying the given function to each element and accumulating the results in a new `Stream` (for example, transforming a `Stream<String>` into a `Stream<Integer>`, or transforming a `Stream<String>` into another `Stream<String>`, and so on).

Using Stream.map()

Basically, we call `Stream.map(Function<? super T,? extends R> mapper)` to apply the `mapper` function on each element of the stream. The result is a new `Stream`. It doesn't modify the source `Stream`.

Let's assume that we have the following `Melon` class:

```
public class Melon {

    private String type;
    private int weight;

    // constructors, getters, setters, equals(),
    // hashCode(), toString() omitted for brevity
}
```

We also need to assume that we have `List<Melon>`:

```
List<Melon> melons = Arrays.asList(new Melon("Gac", 2000),
    new Melon("Hemi", 1600), new Melon("Gac", 3000),
    new Melon("Apollo", 2000), new Melon("Horned", 1700));
```

Furthermore, we want to extract only the names of the melons in another list, `List<String>`.

For this task, we can rely on `map()`, as follows:

```
List<String> melonNames = melons.stream()
    .map(Melon::getType)
    .collect(Collectors.toList());
```

The output will contain the following types of melons:

```
Gac, Hemi, Gac, Apollo, Horned
```

The following diagram depicts how `map()` works for this example:

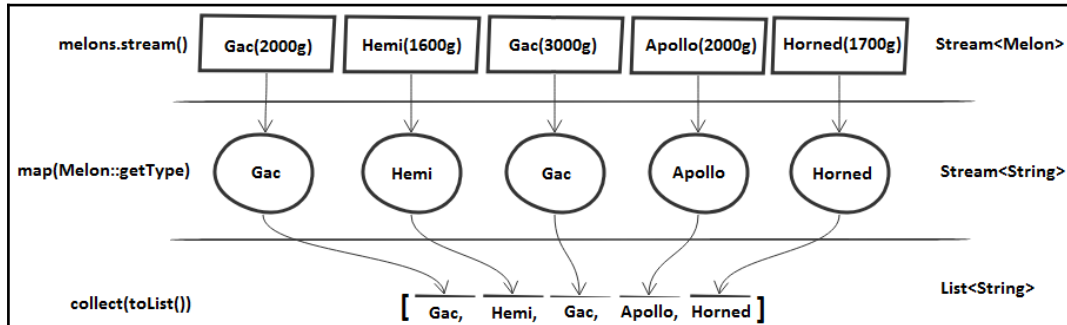

So, the `map()` method gets a `Stream<Melon>` and outputs a `Stream<String>`. Each `Melon` passes through the `map()` method, and this method extracts the melon's type (which is a `String`) and stores it in another `Stream`.

Similarly, we can extract the weights of melons. Since weights are integers, the `map()` method will return a `Stream<Integer>`:

```
List<Integer> melonWeights = melons.stream()
    .map(Melon::getWeight)
    .collect(Collectors.toList());
```

The output will contain the following weights:

```
2000, 1600, 3000, 2000, 1700
```



Beside `map()`, the `Stream` class also provides flavors for primitives such as `mapToInt()`, `mapToLong()`, and `mapToDouble()`. These methods return the `int` primitive specialization of `Stream` (`IntStream`), the `long` primitive specialization of `Stream` (`LongStream`) and the `double` primitive specialization of `Stream` (`StreamDouble`).

While `map()` can map the elements of a `Stream` to a new `Stream` via a `Function`, do not conclude that we can do the following:

```
List<Melon> lighterMelons = melons.stream()
    .map(m -> m.setWeight(m.getWeight() - 500))
    .collect(Collectors.toList());
```

This will not work/compile because the `setWeight()` method returns `void`. In order to make it work, we need to return `Melon`, but this means we have to add some perfunctory code (for example, `return`):

```
List<Melon> lighterMelons = melons.stream()
    .map(m -> {
        m.setWeight(m.getWeight() - 500);

        return m;
    })
    .collect(Collectors.toList());
```

What do you think about the `peek()` temptation? Well, `peek()` stands for *look, but don't touch*, but it can be used to mutate state, as follows:

```
List<Melon> lighterMelons = melons.stream()
    .peek(m -> m.setWeight(m.getWeight() - 500))
    .collect(Collectors.toList());
```

The output will contain the following melons (this looks good):

```
Gac(1500g), Hemi(1100g), Gac(2500g), Apollo(1500g), Horned(1200g)
```

This is more clear than using `map()`. Calling `setWeight()` is a clear signal that we plan to mutate state, but the documentation specifies that the `Consumer` that's passed to `peek()` should be a *non-interfering* action (doesn't modify the data source of the stream).

For sequential streams (such as the preceding one), breaking this expectation can be kept under control without side effects; however, for parallel stream pipelines, the problem may become more complicated.

The action may be called at whatever time and in whatever thread the element is made available by the upstream operation, so if the action modifies the shared state, it is responsible for providing the required synchronization.

As a rule of thumb, think twice before using `peek()` to mutate the state. Also, be aware that this practice is a debate that falls under the bad practice or even anti-pattern umbrella.

Using Stream.flatMap()

As we just saw, `map()` knows how to wrap a sequence of elements in a `Stream`.

This means that `map()` can produce streams such as `Stream<String[]>`, `Stream<List<String>>`, `Stream<Set<String>>`, or even `Stream<Stream<R>>`.

But the problem is that these kinds of streams cannot be manipulated successfully (or, as we expected) by stream operations such as `sum()`, `distinct()`, `filter()`, and `on`.

For example, let's consider the following array of `Melon`:

```
Melon[][] melonsArray = {
    {new Melon("Gac", 2000), new Melon("Hemi", 1600)},
    {new Melon("Gac", 2000), new Melon("Apollo", 2000)},
    {new Melon("Horned", 1700), new Melon("Hemi", 1600)}
};
```

We can take this array and wrap it in a stream via `Arrays.stream()`, as shown in the following snippet of code:

```
Stream<Melon[]> streamOfMelonsArray = Arrays.stream(melonsArray);
```



There are many other ways of obtaining a `Stream` of arrays. For example, if we have a string, `s`, then `map(s -> s.split(""))` will return a `Stream<String[]>`.

Now, we may think that obtaining the distinct `Melon` instances it is enough to call `distinct()`, as follows:

```
streamOfMelonsArray
    .distinct()
    .collect(Collectors.toList());
```

But this is not going to work because `distinct()` will not look for a distinct `Melon`; instead, it will look for a distinct array `Melon[]` because this is what we have in the stream.

Moreover, the result that was returned in this case is of the `Stream<Melon[]>` type, not of the `Stream<Melon>` type. The final result will collect `Stream<Melon[]>` in `List<Melon[]>`.

How we can fix this problem?

We may consider applying `Arrays.stream()` in order to convert the `Melon[]` into a `Stream<Melon>`:

```
streamOfMelonsArray
    .map(Arrays::stream) // Stream<Stream<Melon>>
    .distinct()
    .collect(Collectors.toList());
```

Again, `map()` will not do what we might think it will do.

First, calling `Arrays.stream()` will return a `Stream<Melon>` from each of the given `Melon[]`. However, `map()` returns a `Stream` of elements, and so it will wrap the results of applying `Arrays.stream()` into a `Stream`. It will end up in a `Stream<Stream<Melon>>`.

So, this time, `distinct()` tries to detect distinct `Stream<Melon>` elements:

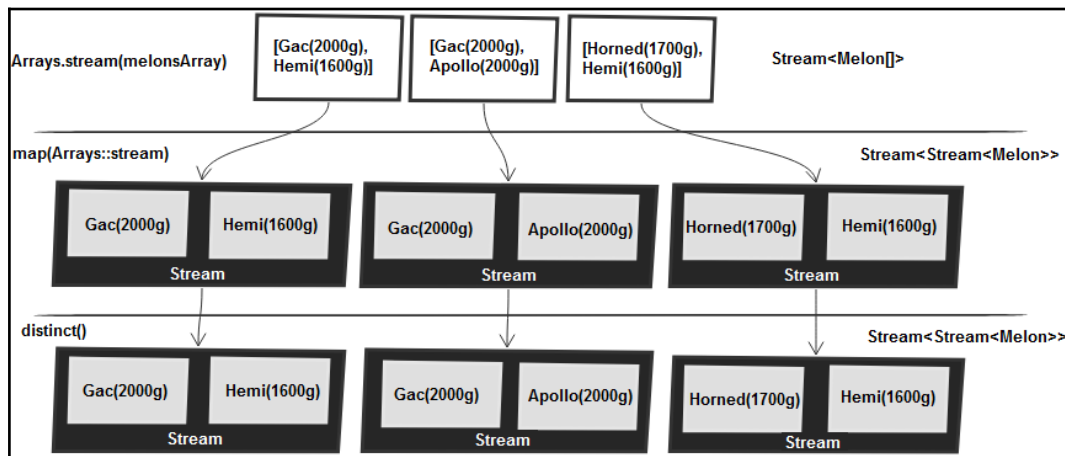

In order to fix this problem, we must rely on `flatMap()`. The following diagram depicts how `flatMap()` works internally:

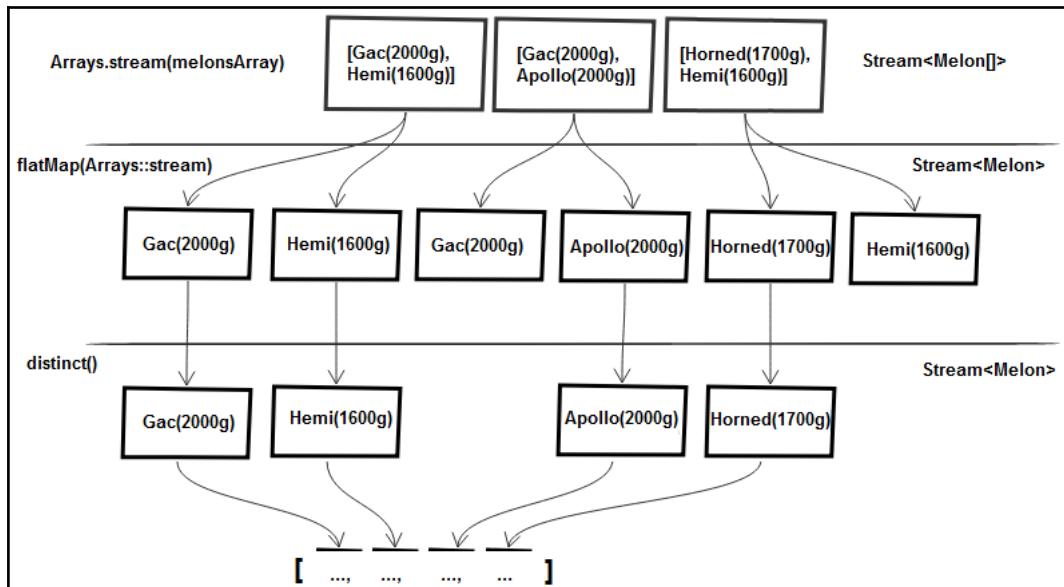

Unlike `map()`, this method returns a stream by flattening all the separated streams. So, all the arrays will end up in the same stream:

```
streamOfMelonsArray
    .flatMap(Arrays::stream) // Stream<Melon>
    .distinct()
    .collect(Collectors.toList());
```

The output will contain distinct melons according to the `Melon.equals()` implementation:

```
Gac(2000g), Hemi(1600g), Apollo(2000g), Horned(1700g)
```

Now, let's try another problem, starting with a `List<List<String>>`, as follows:

```
List<List<String>> melonLists = Arrays.asList(
    Arrays.asList("Gac", "Cantaloupe"),
    Arrays.asList("Hemi", "Gac", "Apollo"),
    Arrays.asList("Gac", "Hemi", "Cantaloupe"),
    Arrays.asList("Apollo"),
    Arrays.asList("Horned", "Hemi"),
    Arrays.asList("Hemi"));
```

We try to obtain the distinct names of melons from this list. If wrapping an array into a stream can be done via `Arrays.stream()`, for a collection, we have `Collection.stream()`. Therefore, the first attempt may look as follows:

```
melonLists.stream()
    .map(Collection::stream)
    .distinct();
```

But based on the previous problem, we already know that this will not work because `map()` will return `Stream<Stream<String>>`.

The solution is provided by `flatMap()`, as follows:

```
List<String> distinctNames = melonLists.stream()
    .flatMap(Collection::stream)
    .distinct()
    .collect(Collectors.toList());
```

The output is as follows:

```
Gac, Cantaloupe, Hemi, Apollo, Horned
```



Beside `flatMap()`, the `Stream` class also provides flavors for primitives such as `flatMapToInt()`, `flatMapToLong()`, and `flatMapToDouble()`. These methods return the `int` primitive specialization of `Stream` (`IntStream`), the `long` primitive specialization of `Stream` (`LongStream`), and the `double` primitive specialization of `Stream` (`StreamDouble`).

183. Finding elements in a stream

Besides using `filter()`, which allows us to filter elements of a stream by a predicate, we can find an element in a stream via `anyFirst()` and `findFirst()`.

Let's assume that we have the following list wrapped in a stream:

```
List<String> melons = Arrays.asList(
    "Gac", "Cantaloupe", "Hemi", "Gac", "Gac",
    "Hemi", "Cantaloupe", "Horned", "Hemi", "Hemi");
```

findAny

The `findAny()` method returns an arbitrary (nondeterministic) element from the stream. For example, the following snippet of code will return an element from the preceding list:

```
Optional<String> anyMelon = melons.stream()
    .findAny();

if (!anyMelon.isEmpty()) {
    System.out.println("Any melon: " + anyMelon.get());
} else {
    System.out.println("No melon was found");
}
```



Notice that there is no guarantee that it will return the same element at each execution. This statement is true especially in the case of parallelizing the stream.

We can combine `findAny()` with other operations as well. Here's an example:

```
String anyApollo = melons.stream()
    .filter(m -> m.equals("Apollo"))
    .findAny()
    .orElse("nope");
```

This time, the result will be `nope`. There is no `Apollo` in the list, and so the `filter()` operation will produce an empty stream. Furthermore, `findAny()` will return an empty stream as well, so `orElse()` will return the final result as the specified string, `nope`.

findFirst

If `findAny()` returns any element, `findFirst()` returns the first element from the stream. Obviously, this method is useful when we are interested only in the first element of a stream (for example, the winner of a contest should be the first element in a sorted list of competitors).



Nevertheless, if the stream has no *encounter order*, then any element may be returned. According to the documentation, *streams may or may not have a defined encounter order. It depends on the source and intermediate operations*. The same rule applies in parallelism as well.

For now, let's assume that we want the first melon in the list:

```
Optional<String> firstMelon = melons.stream()
    .findFirst();

if (!firstMelon.isEmpty()) {
    System.out.println("First melon: " + firstMelon.get());
} else {
    System.out.println("No melon was found");
}
```

The output will be as follows:

```
First melon: Gac
```

We can combine `findFirst()` with other operations as well. Here's an example:

```
String firstApollo = melons.stream()
    .filter(m -> m.equals("Apollo"))
    .findFirst()
    .orElse("nope");
```

This time, the result will be `nope` since the `filter()` will produce an empty stream.

The following is another problem with integers (just follow the right-hand comments to quickly discover the flow):

```
List<Integer> ints = Arrays.asList(4, 8, 4, 5, 5, 7);

int result = ints.stream()
    .map(x -> x * x - 1)    // 23, 63, 23, 24, 24, 48
    .filter(x -> x % 2 == 0) // 24, 24, 48
    .findFirst()          // 24
    .orElse(-1);
```

184. Matching elements in a stream

To match certain elements in a `Stream`, we can rely on the following methods:

- `anyMatch()`
- `noneMatch()`
- `allMatch()`

All of these methods take a `Predicate` as an argument and fetch a boolean result against it.



These three operations rely on the *short-circuiting* technique. In other words, these methods may return until we process the entire stream. For example, if `allMatch()` matches `false` (evaluates the given `Predicate` as `false`), then there is no reason to continue. The final result is `false`.

Let's assume that we have the following list wrapped in a stream:

```
List<String> melons = Arrays.asList(
    "Gac", "Cantaloupe", "Hemi", "Gac", "Gac", "Hemi",
    "Cantaloupe", "Horned", "Hemi", "Hemi");
```

Now, let's try to answer the following questions:

- Does an element match the `Gac` string? Let's see that in the following code:

```
boolean isAnyGac = melons.stream()
    .anyMatch(m -> m.equals("Gac")); // true
```

- Does an element match the `Apollo` string? Let's see that in the following code:

```
boolean isAnyApollo = melons.stream()
    .anyMatch(m -> m.equals("Apollo")); // false
```

As a general question – is there an element in the stream that matches the given predicate?

- Do no elements match the `Gac` string? Let's see that in the following code:

```
boolean isNoneGac = melons.stream()
    .noneMatch(m -> m.equals("Gac")); // false
```

- Do no elements match the `Apollo` string? Let's see that in the following code:

```
boolean isNoneApollo = melons.stream()
    .noneMatch(m -> m.equals("Apollo")); // true
```

As a general question – are there no elements in the stream that match the given predicate?

- Do all the elements match the `Gac` string? Let's see that in the following code:

```
boolean areAllGac = melons.stream()
    .allMatch(m -> m.equals("Gac")); // false
```

- Are all the elements larger than 2? Let's see that in the following code:

```
boolean areAllLargerThan2 = melons.stream()
    .allMatch(m -> m.length() > 2);
```

As a general question—do all the elements in the stream match the given predicate?

185. Sum, max, and min in a stream

Let's assume that we have the following `Melon` class:

```
public class Melon {

    private String type;
    private int weight;

    // constructors, getters, setters, equals(),
    // hashCode(), toString() omitted for brevity
}
```

Let's also assume that we have the following list of `Melon` wrapped in a stream:

```
List<Melon> melons = Arrays.asList(new Melon("Gac", 2000),
    new Melon("Hemi", 1600), new Melon("Gac", 3000),
    new Melon("Apollo", 2000), new Melon("Horned", 1700));
```

Let's work on the `Melon` class using the `sum()`, `min()`, and `max()` terminal operations.

The `sum()`, `min()`, and `max()` terminal operations

Now, let's combine the elements of this stream to express the following queries:

- How can we calculate the total weight of melons (`sum()`)?
- What is the heaviest melon (`max()`)?
- What is the lightest melon (`min()`)?

In order to calculate the total weight of melons, we need to sum up all the weights. For primitive specializations of `Stream` (`IntStream`, `LongStream`, and so on), the Java Stream API exposes a terminal operation named `sum()`. As its name suggests, this method sums up the elements of the stream:

```
int total = melons.stream()
    .mapToInt(Melon::getWeight)
    .sum();
```

After `sum()`, we also have the `max()` and `min()` terminal operations. Obviously, `max()` returns the maximum value of the stream, while `min()` is its opposite:

```
int max = melons.stream()
    .mapToInt(Melon::getWeight)
    .max()
    .orElse(-1);

int min = melons.stream()
    .mapToInt(Melon::getWeight)
    .min()
    .orElse(-1);
```



The `max()` and `min()` operations return an `OptionalInt` (such as `OptionalLong`). If the maximum or minimum cannot be calculated (for example, in the case of an empty stream) then we choose to return `-1`. Since we are working with weights, and with positive numbers by their nature, returning `-1` makes sense. But don't take this as a rule. Depending on the case, another value should be returned, or maybe using `orElseGet()/orElseThrow()` would be better.

For non-primitive specializations, check out the *Summarization collectors* section of this chapter.

Let's learn about reducing in the next section.

Reducing

`sum()`, `max()`, and `min()` are known as special cases of *reduction*. By *reduction*, we mean an abstraction based on two main statements:

- Take an initial value (`T`)
- Take a `BinaryOperator<T>` to combine two elements and produce a new value

Reductions can be accomplished via a terminal operation named `reduce()`, which follows this abstraction and defines two signatures (the second one doesn't use an initial value):

- `T reduce(T identity, BinaryOperator<T> accumulator)`
- `Optional<T> reduce(BinaryOperator<T> accumulator)`

With that being said, we can rely on the `reduce()` terminal operation to compute the sum of the elements, as follows (the initial value is `0`, and the lambda is `(m1, m2) -> m1 + m2`):

```
int total = melons.stream()
    .map(Melon::getWeight)
    .reduce(0, (m1, m2) -> m1 + m2);
```

The following diagram depicts how the `reduce()` operation works:

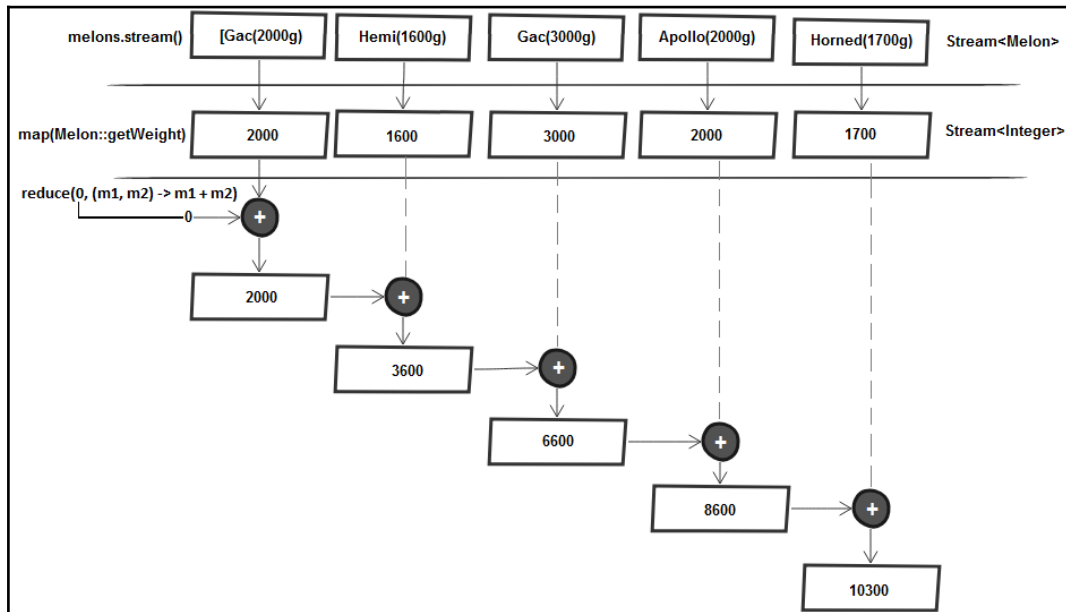

So, how does the `reduce()` operation work?

Let's take a look at the following steps to figure this out:

1. First, `0` is used as the first parameter of the lambda (m_1), and `2,000` is consumed from the stream and used as the second parameter (m_2). `0 + 2000` produces `2000`, and this becomes the new accumulated value.
2. Then, the lambda is called again with the accumulated value and the next element of the stream, `1,600`, which produces the new accumulated value, `3,600`.
3. Moving forward, the lambda is called again with the accumulated value and the next element, `3,000`, which produces `6,600`.
4. If we step forward again, the lambda is called again with the accumulated value and the next element, `2,000`, which produces `8,600`.
5. Finally, the lambda is called with `8,600` and the last element of the stream, `1,700`, which produces the final value, `10,300`.

The maximum and minimum can be calculated as well:

```
int max = melons.stream()
    .map(Melon::getWeight)
    .reduce(Integer::max)
    .orElse(-1);

int min = melons.stream()
    .map(Melon::getWeight)
    .reduce(Integer::min)
    .orElse(-1);
```

The advantage of using `reduce()` is that we can easily change the computation by simply passing another lambda. For example, we can quickly replace the sum with the product, as shown in the following example:

```
List<Double> numbers = Arrays.asList(1.0d, 5.0d, 8.0d, 10.0d);

double total = numbers.stream()
    .reduce(1.0d, (x1, x2) -> x1 * x2);
```

Nevertheless, pay attention to cases that can lead to unwanted results. For example, if we want to compute the harmonic mean of the given numbers then there is not an *out of the box* special case of *reduction*, and so we can only rely on `reduce()`, as follows:

```
List<Double> numbers = Arrays.asList(1.0d, 5.0d, 8.0d, 10.0d);
```

The harmonic mean formula is as follows:

$$H = \frac{n}{\frac{1}{x_1} + \frac{1}{x_2} + \dots + \frac{1}{x_n}} = \frac{n}{\sum_{i=1}^n \frac{1}{x_i}} = \left(\frac{\sum_{i=1}^n x_i^{-1}}{n} \right)^{-1}$$

In our case, n is the size of the list and H is 2.80701. Using a naive `reduce()` function will look as follows:

```
double hm = numbers.size() / numbers.stream()
    .reduce((x1, x2) -> (1.0d / x1 + 1.0d / x2))
    .orElseThrow();
```

This will produce 3.49809.

This explanation relies on how we have expressed the calculation. In the first step, we calculate $1.0/1.0 + 1.0/5.0 = 1.2$. Then, we may expect to do $1.2 + 1.0/1.8$, but actually, the calculation is $1.0/1.2 + 1.0/1.8$. Obviously, this is not what we want.

We can fix this by using `mapToDouble()`, as follows:

```
double hm = numbers.size() / numbers.stream()
    .mapToDouble(x -> 1.0d / x)
    .reduce((x1, x2) -> (x1 + x2))
    .orElseThrow();
```

This will produce the expected result, that is, 2.80701.

186. Collecting the result of a stream

Let's assume that we have the following `Melon` class:

```
public class Melon {

    private String type;
    private int weight;

    // constructors, getters, setters, equals(),
    // hashCode(), toString() omitted for brevity
}
```

Let's also assume that we have the `List` of `Melon`:

```
List<Melon> melons = Arrays.asList(new Melon("Crenshaw", 2000),
    new Melon("Hemi", 1600), new Melon("Gac", 3000),
    new Melon("Apollo", 2000), new Melon("Horned", 1700),
    new Melon("Gac", 3000), new Melon("Cantaloupe", 2600));
```

Typically, a stream pipeline ends up with a summary of the elements in the stream. In other words, we need to collect the results in a data structure such as `List`, `Set`, or `Map` (and their companions).

For accomplishing this task, we can rely on the `Stream.collect(Collector<? super T,A,R> collector)` method. This method gets a single argument representing a `java.util.stream.Collector` or a user-defined `Collector`.

The most famous collectors include the following:

- `toList()`
- `toSet()`
- `toMap()`
- `toCollection()`

Their names speak for themselves. Let's take a look at several examples:

- Filter melons that are heavier than 1,000 g and collect the result in a `List` via `toList()` and `toCollection()`:

```
List<Integer> resultToList = melons.stream()
    .map(Melon::getWeight)
    .filter(x -> x >= 1000)
    .collect(Collectors.toList());
```

```
List<Integer> resultToList = melons.stream()
    .map(Melon::getWeight)
    .filter(x -> x >= 1000)
    .collect(Collectors.toCollection(ArrayList::new));
```

The argument of the `toCollection()` method is a `Supplier` that provides a new empty `Collection` into which the results will be inserted.

- Filter melons that are heavier than 1,000 g and collect the result without duplicates in a `Set` via `toSet()` and `toCollection()`:

```
Set<Integer> resultToSet = melons.stream()
    .map(Melon::getWeight)
    .filter(x -> x >= 1000)
    .collect(Collectors.toSet());
```

```
Set<Integer> resultToSet = melons.stream()
    .map(Melon::getWeight)
    .filter(x -> x >= 1000)
    .collect(Collectors.toCollection(HashSet::new));
```

- Filter melons that are heavier than 1,000 grams, collect the result without duplicates, and sort into ascending order in a Set via `toCollection()`:

```
Set<Integer> resultToSet = melons.stream()
    .map(Melon::getWeight)
    .filter(x -> x >= 1000)
    .collect(Collectors.toCollection(TreeSet::new));
```

- Filter a distinct Melon and collect the result in a `Map<String, Integer>` via `toMap()`:

```
Map<String, Integer> resultToMap = melons.stream()
    .distinct()
    .collect(Collectors.toMap(Melon::getType,
        Melon::getWeight));
```

The two arguments of the `toMap()` method represent a mapping function that's used to produce keys and their respective values (this is prone to the `java.lang.IllegalStateException duplicate key` exception if two Melon have the same key).

- Filter a distinct Melon and collect the result in a `Map<Integer, Integer>` via `toMap()` using random keys (prone to the `java.lang.IllegalStateException duplicate key` if two identical keys are generated):

```
Map<Integer, Integer> resultToMap = melons.stream()
    .distinct()
    .map(x -> Map.entry(
        new Random().nextInt(Integer.MAX_VALUE), x.getWeight()))
    .collect(Collectors.toMap(Entry::getKey, Entry::getValue));
```

- Collect a Melon in a map via `toMap()` and avoid the potential `java.lang.IllegalStateException duplicate key` by choosing the existing (old) value in case of a key collision:

```
Map<String, Integer> resultToMap = melons.stream()
    .collect(Collectors.toMap(Melon::getType, Melon::getWeight,
        (oldValue, newValue) -> oldValue));
```

The last argument of the `toMap()` method is a merge function and is used to resolve collisions between values associated with the same key, as supplied to `Map.merge(Object, Object, BiFunction)`.

Obviously, choosing the new value can be done with `(oldValue, newValue) -> newValue`:

- Put the preceding example into a sorted Map (for example, by weight):

```
Map<String, Integer> resultToMap = melons.stream()
    .sorted(Comparator.comparingInt(Melon::getWeight))
    .collect(Collectors.toMap(Melon::getType, Melon::getWeight,
        (oldValue, newValue) -> oldValue,
        LinkedHashMap::new));
```

The last argument of this `toMap()` flavor represents a Supplier that provides a new empty Map into which the results will be inserted. In this example, this Supplier is needed to preserve the order after sorting. Since `HashMap` doesn't guarantee the order of insertion, we need to rely on `LinkedHashMap`.

- Collect the word frequency count via `toMap()`:

```
String str = "Lorem Ipsum is simply
    Ipsum Lorem not simply Ipsum";

Map<String, Integer> mapOfWords = Stream.of(str)
    .map(w -> w.split("\\s+"))
    .flatMap(Arrays::stream)
    .collect(Collectors.toMap(
        w -> w.toLowerCase(), w -> 1, Integer::sum));
```



Beside `toList()`, `toMap()`, and `toSet()`, the `Collectors` class also exposes collectors to unmodifiable and concurrent collections such as `toUnmodifiableList()`, `toConcurrentMap()`, and so on.

187. Joining the results of a stream

Let's assume that we have the following `Melon` class:

```
public class Melon {  
  
    private String type;  
    private int weight;  
  
    // constructors, getters, setters, equals(),  
    // hashCode(), toString() omitted for brevity  
}
```

Let's also assume that we have the `List` of `Melon`:

```
List<Melon> melons = Arrays.asList(new Melon("Crenshaw", 2000),  
    new Melon("Hemi", 1600), new Melon("Gac", 3000),  
    new Melon("Apollo", 2000), new Melon("Horned", 1700),  
    new Melon("Gac", 3000), new Melon("Cantaloupe", 2600));
```

In the previous problem, we talked about the `Stream` API that's built into `Collectors`. In this category, we also have `Collectors.joining()`. The goal of these collectors is to concatenate the elements of a stream into a `String` in the *encounter order*. Optionally, these collectors can use a delimiter, a prefix, and a suffix, and so the most comprehensive `joining()` flavor is `String joining(CharSequence delimiter, CharSequence prefix, CharSequence suffix)`.

But if all we want is to concatenate the names of melons without a delimiter, then this is the way to go (just for fun, let's sort and remove the duplicates as well):

```
String melonNames = melons.stream()  
    .map(Melon::getType)  
    .distinct()  
    .sorted()  
    .collect(Collectors.joining());
```

We will receive the following output:

```
ApolloCantaloupeCrenshawGacHemiHorned
```

A nicer solution consists of adding a delimiter, for example, a comma and a space:

```
String melonNames = melons.stream()  
    ...  
    .collect(Collectors.joining(", "));
```

We will receive the following output:

```
Apollo, Cantaloupe, Crenshaw, Gac, Hemi, Horned
```

We can also enrich the output with a prefix and suffix:

```
String melonNames = melons.stream()
    ...
    .collect(Collectors.joining(", ",
        "Available melons: ", " Thank you!"));
```

We will receive the following output:

```
Available melons: Apollo, Cantaloupe, Crenshaw, Gac, Hemi, Horned
Thank you!
```

188. Summarization collectors

Let's assume that we have the well-known `Melon` class (that uses `type` and `weight`) and `List of Melon`:

```
List<Melon> melons = Arrays.asList(new Melon("Crenshaw", 2000),
    new Melon("Hemi", 1600), new Melon("Gac", 3000),
    new Melon("Apollo", 2000), new Melon("Horned", 1700),
    new Melon("Gac", 3000), new Melon("Cantaloupe", 2600));
```

The Java `Stream` API groups the `count`, `sum`, `min`, `average`, and `max` operations under the term *summarization*. The methods dedicated to performing *summarization* operations are found in the `Collectors` class.

We'll take a look at all of these operations in the following sections.

Summing

Let's assume that we want to sum all the weights of melons. We did this in the *Sum, max, and min in a stream* section via primitive specializations of `Stream`. Now, let's do it via the `summingInt (ToIntFunction<? super T> mapper)` collector:

```
int sumWeightsGrams = melons.stream()
    .collect(Collectors.summingInt(Melon::getWeight));
```

So, `Collectors.summingInt()` is a factory method that takes a function that's capable of mapping an object into an `int` that has to be summed as an argument. A collector is returned that performs the *summarization* via the `collect()` method. The following diagram depicts how `summingInt()` works:

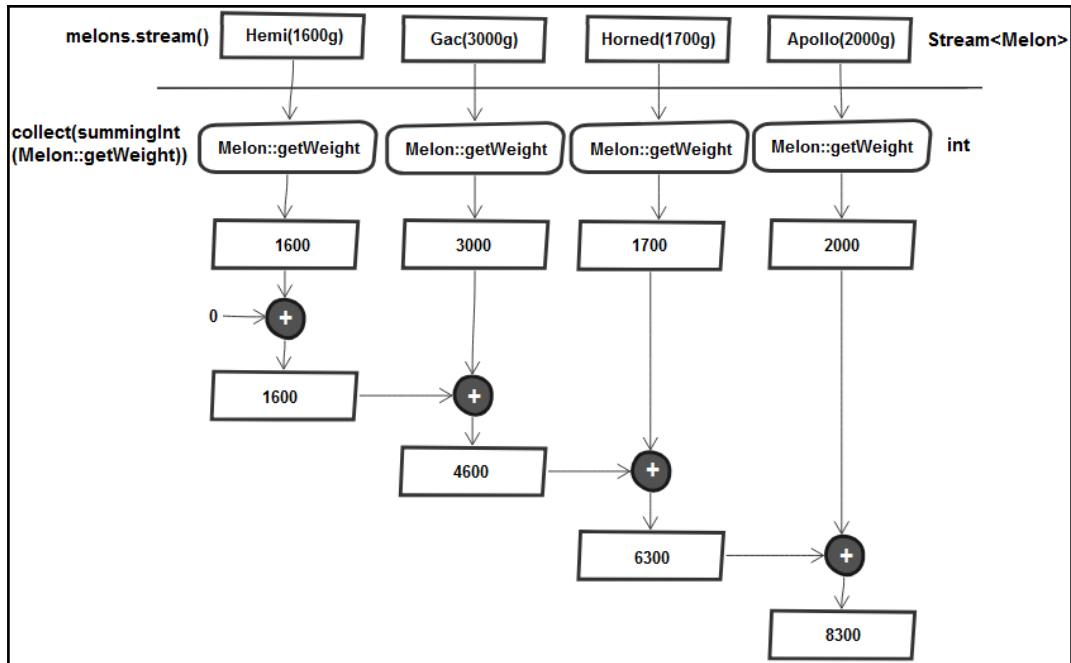

While traversing the stream, each weight (`Melon::getWeight`) is mapped to its number, and this number is added to an accumulator, starting from the initial value, that is, 0.

After `summingInt()`, we have `summingLong()` and `summingDouble()`. How do we sum up the weights of melons in kilograms? This can be accomplished via `summingDouble()`, as follows:

```
double sumWeightsKg = melons.stream()
    .collect(Collectors.summingDouble(
        m -> (double) m.getWeight() / 1000.0d));
```

If we just need the result in kilograms, we can still perform the sum in grams, as follows:

```
double sumWeightsKg = melons.stream()
    .collect(Collectors.summingInt(Melon::getWeight)) / 1000.0d;
```

Since *summarizations* are actually *reductions*, the `Collectors` class provides a `reducing()` method as well. Obviously, this method has a more general utilization, allowing us to provide all kinds of lambdas via its three flavors:

- `reducing(BinaryOperator<T> op)`
- `reducing(T identity, BinaryOperator<T> op)`
- `reducing(U identity, Function<? super T, ? extends U> mapper, BinaryOperator<U> op)`

The arguments of `reducing()` are pretty straightforward. We have the `identity` value for the reduction (as well as the value that is returned when there are no input elements), a mapping function to apply to each input value, and a function that's used to reduce the mapped values.

For example, let's rewrite the preceding snippet of code via `reducing()`. Notice that we start the sum from 0, convert it from grams into kilograms via a mapping function, and reduce the values (the resulted kilograms) via a lambda:

```
double sumWeightsKg = melons.stream()
    .collect(Collectors.reducing(0.0,
        m -> (double) m.getWeight() / 1000.0d, (m1, m2) -> m1 + m2));
```

Alternatively, we can simply convert to kilograms at the end:

```
double sumWeightsKg = melons.stream()
    .collect(Collectors.reducing(0,
        m -> m.getWeight(), (m1, m2) -> m1 + m2)) / 1000.0d;
```



Rely on `reducing()` whenever there is no suitable built-in solution. Think of `reducing()` as a *generalized summarization*.

Averaging

How about computing the average weight of a melon?

For this, we have `Collectors.averagingInt()`, `averagingLong()`, and `averagingDouble()`:

```
double avgWeights = melons.stream()
    .collect(Collectors.averagingInt(Melon::getWeight));
```

Counting

Counting the number of words in a piece of text is a common problem that can be solved by `count()`:

```
String str = "Lorem Ipsum is simply dummy text ...";

long numberOfWords = Stream.of(str)
    .map(w -> w.split("\\s+"))
    .flatMap(Arrays::stream)
    .filter(w -> w.trim().length() != 0)
    .count();
```

But let's see how many Melon weighing 3,000 there are in our stream:

```
long nrOfMelon = melons.stream()
    .filter(m -> m.getWeight() == 3000)
    .count();
```

We can use the collector that's returned by the `counting()` factory method:

```
long nrOfMelon = melons.stream()
    .filter(m -> m.getWeight() == 3000)
    .collect(Collectors.counting());
```

We can also use the clumsy approach of using `reducing()`:

```
long nrOfMelon = melons.stream()
    .filter(m -> m.getWeight() == 3000)
    .collect(Collectors.reducing(0L, m -> 1L, Long::sum));
```

Maximum and minimum

In the *Sum, max, and min in a stream* section, we already computed the minimum and maximum value via the `min()` and `max()` methods. This time, let's compute the heaviest and the lightest Melon via the `Collectors.maxBy()` and `Collectors.minBy()` collectors. These collectors take a `Comparator` as an argument to compare the elements in the stream and return an `Optional` (this `Optional` will be empty if the stream is empty):

```
Comparator<Melon> byWeight = Comparator.comparing(Melon::getWeight);

Melon heaviestMelon = melons.stream()
    .collect(Collectors.maxBy(byWeight))
    .orElseThrow();
```

```
Melon lightestMelon = melons.stream()
    .collect(Collectors.minBy(byWeight))
    .orElseThrow();
```

In this case, if the stream is empty, we just throw `NoSuchElementException`.

Getting all

Is there a way to obtain the count, sum, average, min, and max in a single unitary operation?

Yes, there is! Whenever we need two or more of these operations, we can rely on `Collectors.summarizingInt()`, `summarizingLong()`, and `summarizingDouble()`. These methods wrap these operations in `IntSummaryStatistics`, `LongSummaryStatistics`, and `DoubleSummaryStatistics`, respectively, as follows:

```
IntSummaryStatistics melonWeightsStatistics = melons
    .stream().collect(Collectors.summarizingInt(Melon::getWeight));
```

Printing this object produces the following output:

```
IntSummaryStatistics{count=7, sum=15900, min=1600,
    average=2271.428571, max=3000}
```

For each of these operations, we have dedicated getters:

```
int max = melonWeightsStatistics.getMax()
```

We're all done! Now, let's talk about grouping elements of a stream.

189. Grouping

Let's assume that we have the following `Melon` class and `List of Melon`:

```
public class Melon {

    enum Sugar {
        LOW, MEDIUM, HIGH, UNKNOWN
    }

    private final String type;
    private final int weight;
    private final Sugar sugar;
```

```
// constructors, getters, setters, equals(),
// hashCode(), toString() omitted for brevity
}

List<Melon> melons = Arrays.asList(
    new Melon("Crenshaw", 1200),
    new Melon("Gac", 3000), new Melon("Hemi", 2600),
    new Melon("Hemi", 1600), new Melon("Gac", 1200),
    new Melon("Apollo", 2600), new Melon("Horned", 1700),
    new Melon("Gac", 3000), new Melon("Hemi", 2600)
);
```

The Java Stream API exposes the same functionality as the SQL `GROUP BY` clause via `Collectors.groupingBy()`.

While the SQL `GROUP BY` clause works on database tables, `Collectors.groupingBy()` works on elements of streams.

In other words, the `groupingBy()` methods are capable of grouping elements with certain distinguishing characteristics. Before streams and functional-style programming (Java 8), such tasks were applied to collections via a bunch of *spaghetti* code that was cumbersome, verbose, and error-prone. Starting with Java 8, we have *grouping collectors*.

Let's take a look at single-level grouping and multilevel grouping in the next section. We will start with single-level grouping.

Single-level grouping

All grouping collectors have a *classification function* (the function that classifies the elements of the stream into different groups). Mainly, this is an instance of the `Function<T, R>` functional interface.

Each element of the stream (of the `T` type) is passed through this function, and the return will be a *classifier object* (of the `R` type). All the returned `R` types represent the keys (`K`) of a `Map<K, V>`, and each group is a value in this `Map<K, V>`.

In other words, the key (κ) is the value returned by the classification function, and the value (v) is a list of elements in the stream that have this classified value (κ). So, the final result is of the `Map<K, List<T>>` type.

Let's look at an example to bring some light to this brain-teasing explanation. This example relies on the simplest flavor of `groupingBy()`, that is, `groupingBy(Function<? super T,? extends K> classifier)`.

So, let's group `Melon` by type:

```
Map<String, List<Melon>> byTypeInList = melons.stream()
    .collect(groupingBy(Melon::getType));
```

The output will be as follows:

```
{
  Crenshaw = [Crenshaw(1200 g)],
  Apollo = [Apollo(2600 g)],
  Gac = [Gac(3000 g), Gac(1200 g), Gac(3000 g)],
  Hemi = [Hemi(2600 g), Hemi(1600 g), Hemi(2600 g)],
  Horned = [Horned(1700 g)]
}
```

We can also group `Melon` by weight:

```
Map<Integer, List<Melon>> byWeightInList = melons.stream()
    .collect(groupingBy(Melon::getWeight));
```

The output will be as follows:

```
{
  1600 = [Hemi(1600 g)],
  1200 = [Crenshaw(1200 g), Gac(1200 g)],
  1700 = [Horned(1700 g)],
  2600 = [Hemi(2600 g), Apollo(2600 g), Hemi(2600 g)],
  3000 = [Gac(3000 g), Gac(3000 g)]
}
```

This grouping is shown in the following diagram. More precisely, this is a snapshot of the moment when `Gac(1200 g)` passes through the classification function (`Melon::getWeight`):

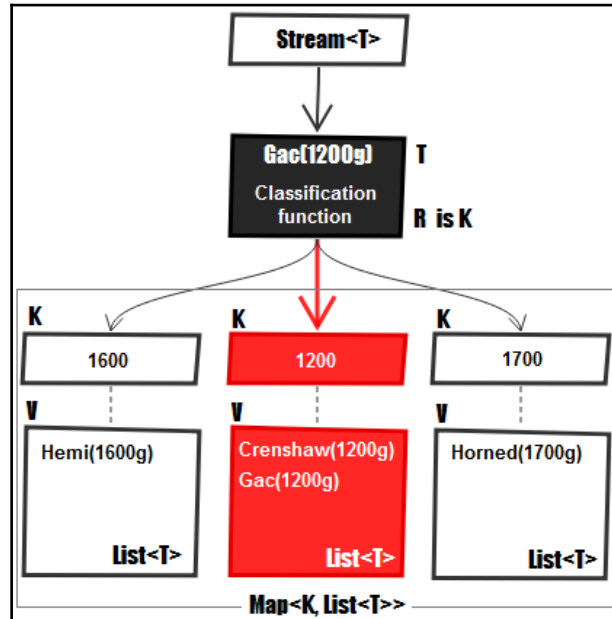

So, in the melon-classification example, a key is the weight of `Melon`, and its value is a list containing all the `Melon` objects of that weight.



The classification function can be a method reference or any other lambda.

One issue with the preceding approach is the presence of unwanted duplicates. This happens because the values are collected in a `List` (for example, `3000=[Gac(3000g), Gac(3000g)]`). But we can fix this by relying on another flavor of `groupBy()`, that is, `groupBy(Function<? super T, ? extends K> classifier, Collector<? super T, A, D> downstream)`.

This time, we can specify the desired downstream collector as the second argument. So, besides the classification function, we have a downstream collector as well.

If we wish to reject duplicates, we can use `Collectors.toSet()`, as follows:

```
Map<String, Set<Melon>> byTypeInSet = melons.stream()
    .collect(groupingBy(Melon::getType, toSet()));
```

The output is as follows:

```
{
  Crenshaw = [Crenshaw(1200 g)],
  Apollo = [Apollo(2600 g)],
  Gac = [Gac(1200 g), Gac(3000 g)],
  Hemi = [Hemi(2600 g), Hemi(1600 g)],
  Horned = [Horned(1700 g)]
}
```

We can also do this by weight:

```
Map<Integer, Set<Melon>> byWeightInSet = melons.stream()
    .collect(groupingBy(Melon::getWeight, toSet()));
```

The output will be as follows:

```
{
  1600 = [Hemi(1600 g)],
  1200 = [Gac(1200 g), Crenshaw(1200 g)],
  1700 = [Horned(1700 g)],
  2600 = [Hemi(2600 g), Apollo(2600 g)],
  3000 = [Gac(3000 g)]
}
```

Of course, in this case, `distinct()` can be used as well:

```
Map<String, List<Melon>> byTypeInList = melons.stream()
    .distinct()
    .collect(groupingBy(Melon::getType));
```

The same goes for doing this by weight:

```
Map<Integer, List<Melon>> byWeightInList = melons.stream()
    .distinct()
    .collect(groupingBy(Melon::getWeight));
```

Well, there are no more duplicates, but the results are not ordered. It would be nice to have this map ordered by keys, so the default `HashMap` is not very useful. If we could specify a `TreeMap` instead of the default `HashMap`, then the problem will be solved.

We can do this via another flavor of `groupingBy()`, that is, `groupingBy(Function<? super T, ? extends K> classifier, Supplier<M> mapFactory, Collector<? super T, A, D> downstream)`.

The second argument of this flavor allows us to provide a `Supplier` object that provides a new empty `Map` into which the results will be inserted:

```
Map<Integer, Set<Melon>> byWeightInSetOrdered = melons.stream()
    .collect(groupingBy(Melon::getWeight, TreeMap::new, toSet()));
```

Now, the output is ordered:

```
{
  1200 = [Gac(1200 g), Crenshaw(1200 g)],
  1600 = [Hemi(1600 g)],
  1700 = [Horned(1700 g)],
  2600 = [Hemi(2600 g), Apollo(2600 g)],
  3000 = [Gac(3000 g)]
}
```

We can also have a `List<Integer>` containing the weights of 100 melons:

```
List<Integer> allWeights = new ArrayList<>(100);
```

We want to split this list into 10 lists of 10 weights each. Basically, we can obtain this via `grouping`, as follows (we can apply `parallelStream()` as well):

```
final AtomicInteger count = new AtomicInteger();
Collection<List<Integer>> chunkWeights = allWeights.stream()
    .collect(Collectors.groupingBy(c -> count.getAndIncrement() / 10))
    .values();
```

Now, let's tackle another issue. By default, `Stream<Melon>` is divided into a suite of `List<Melon>`. But what can we do to divide `Stream<Melon>` into a suite of `List<String>`, where each list is holding only the types of melons, not the `Melon` instances?

Well, transforming elements of a stream is commonly the job of `map()`. But inside `groupingBy()`, this is the job of `Collectors.mapping()` (more details can be found in the *Filtering, flattening, and mapping collectors* section of this chapter):

```
Map<Integer, Set<String>> byWeightInSetOrdered = melons.stream()
    .collect(groupingBy(Melon::getWeight, TreeMap::new,
        mapping(Melon::getType, toSet())));
```

This time, the output is exactly what we wanted:

```
{
  1200 = [Crenshaw, Gac],
  1600 = [Hemi],
  1700 = [Horned],
  2600 = [Apollo, Hemi],
  3000 = [Gac]
}
```

Ok, so far, so good! Now, let's focus on the fact that two of the three flavors of `groupingBy()` accept a collector as an argument (for example, `toSet()`). This can be any collector. For example, we may want to group melons by types and count them. For this, `Collectors.counting()` is very helpful (more details can be found in the *Summarization collectors* section):

```
Map<String, Long> typesCount = melons.stream()
    .collect(groupingBy(Melon::getType, counting()));
```

The output will be as follows:

```
{Crenshaw=1, Apollo=1, Gac=3, Hemi=3, Horned=1}
```

We can also do this by weight:

```
Map<Integer, Long> weightsCount = melons.stream()
    .collect(groupingBy(Melon::getWeight, counting()));
```

The output will be as follows:

```
{1600=1, 1200=2, 1700=1, 2600=3, 3000=2}
```

Can we group the lightest and heaviest melons by type? Of course we can! We can do this via `Collectors.minBy()` and `maxBy()`, which were presented in the *Summarization collectors* section:

```
Map<String, Optional<Melon>> minMelonByType = melons.stream()
    .collect(groupingBy(Melon::getType,
        minBy(comparingInt(Melon::getWeight))));
```

The output will be as follows (notice that `minBy()` returns an `Optional`):

```
{
  Crenshaw = Optional[Crenshaw(1200 g)],
  Apollo = Optional[Apollo(2600 g)],
  Gac = Optional[Gac(1200 g)],
  Hemi = Optional[Hemi(1600 g)],
  Horned = Optional[Horned(1700 g)]
}
```

We can also do this via `maxMelonByType()`:

```
Map<String, Optional<Melon>> maxMelonByType = melons.stream()
  .collect(groupingBy(Melon::getType,
    maxBy(comparingInt(Melon::getWeight))));
```

The output will be as follows (notice that `maxBy()` returns an `Optional`):

```
{
  Crenshaw = Optional[Crenshaw(1200 g)],
  Apollo = Optional[Apollo(2600 g)],
  Gac = Optional[Gac(3000 g)],
  Hemi = Optional[Hemi(2600 g)],
  Horned = Optional[Horned(1700 g)]
}
```



The `minBy()` and `maxBy()` collectors take a `Comparator` as an argument. In these examples, we have used the built-in `Comparator.comparingInt()` function. Starting with JDK 8, the `java.util.Comparator` class was enriched with several new comparators, including the `thenComparing()` flavors for chaining comparators.

The issue here is represented by the optionals that should be removed. More generally, this category of issues continues to adapt the result returned by a collector to a different type.

Well, especially for these kinds of tasks, we have the `collectingAndThen(Collector<T,A,R> downstream, Function<R,RR> finisher)` factory method. This method takes a function that will be applied to the final result of the downstream collector (`finisher`). It can be used as follows:

```
Map<String, Integer> minMelonByType = melons.stream()
  .collect(groupingBy(Melon::getType,
    collectingAndThen(minBy(comparingInt(Melon::getWeight)),
      m -> m.orElseThrow().getWeight())));
```

The output will be as follows:

```
{Crenshaw=1200, Apollo=2600, Gac=1200, Hemi=1600, Horned=1700}
```

We can also use `maxMelonByType()`:

```
Map<String, Integer> maxMelonByType = melons.stream()
    .collect(groupingBy(Melon::getType,
        collectingAndThen(maxBy(comparingInt(Melon::getWeight)),
            m -> m.orElseThrow().getWeight())));
```

The output will be as follows:

```
{Crenshaw=1200, Apollo=2600, Gac=3000, Hemi=2600, Horned=1700}
```

We may also want to group melons by type in `Map<String, Melon[]>`. Again, we can rely on `collectingAndThen()` for this, as follows:

```
Map<String, Melon[]> byTypeArray = melons.stream()
    .collect(groupingBy(Melon::getType, collectingAndThen(
        Collectors.toList(), l -> l.toArray(Melon[]::new))));
```

Alternatively, we can create a generic collector and call it, as follows:

```
private static <T> Collector<T, ?, T[]>
    toArray(IntFunction<T[]> func) {

    return Collectors.collectingAndThen(
        Collectors.toList(), l -> l.toArray(func.apply(l.size())));
}

Map<String, Melon[]> byTypeArray = melons.stream()
    .collect(groupingBy(Melon::getType, toArray(Melon[]::new)));
```

Multilevel grouping

Earlier, we mentioned that two of three flavors of `groupingBy()` take another collector as an argument. Moreover, we said that this can be any collector. By any collector, we mean `groupingBy()` as well.

By passing `groupingBy()` to `groupingBy()`, we can achieve *n*-levels of grouping or multilevel grouping. Mainly, we have *n*-levels of classification functions.

Let's consider the following list of `Melon`:

```
List<Melon> melonsSugar = Arrays.asList(
    new Melon("Crenshaw", 1200, HIGH),
    new Melon("Gac", 3000, LOW), new Melon("Hemi", 2600, HIGH),
    new Melon("Hemi", 1600), new Melon("Gac", 1200, LOW),
    new Melon("Cantaloupe", 2600, MEDIUM),
    new Melon("Cantaloupe", 3600, MEDIUM),
    new Melon("Apollo", 2600, MEDIUM), new Melon("Horned", 1200, HIGH),
    new Melon("Gac", 3000, LOW), new Melon("Hemi", 2600, HIGH));
```

So, each `Melon` has a type, a weight, and an indicator of sugar level. First, we want to group melons by the sugar indicator (LOW, MEDIUM, HIGH, or UNKNOWN (default)). Furthermore, we want to group melons by weight. This can be accomplished via two levels of grouping, as follows:

```
Map<Sugar, Map<Integer, Set<String>>> bySugarAndWeight =
    melonsSugar.stream()
        .collect(groupingBy(Melon::getSugar,
            groupingBy(Melon::getWeight, TreeMap::new,
                mapping(Melon::getType, toSet()))));
```

The output is as follows:

```
{
  MEDIUM = {
    2600 = [Apollo, Cantaloupe], 3600 = [Cantaloupe]
  },
  HIGH = {
    1200 = [Crenshaw, Horned], 2600 = [Hemi]
  },
  UNKNOWN = {
    1600 = [Hemi]
  },
  LOW = {
    1200 = [Gac], 3000 = [Gac]
  }
}
```

We can now say that Crenshaw and Horned weigh 1,200 g and have a high percentage of sugar. We also have Hemi at 2,600 g with a high percentage of sugar.

We can even represent our data in a table, as shown in the following diagram:

sugar weight	LOW	MEDIUM	HIGH	UNKNOWN
2600		Apollo Cantaloupe	Hemi	
3600		Cantaloupe		
1200	Gac		Crenshaw Horned	
1600				Hemi
3000	Gac			

Now, let's learn about partitioning.

190. Partitioning

Partitioning is a type of grouping that relies on a `Predicate` to divide a stream into two groups (a group for `true` and a group for `false`). The group for `true` stores the elements of the stream that have passed the predicate, while the group of `false` stores the rest of the elements (the elements that fail the predicate).

This `Predicate` represents the *classification function* of partitioning and is known as the *partitioning function*. Since the `Predicate` is evaluated to a `boolean` value, the partitioning operation returns a `Map<Boolean, V>`.

Let's assume that we have the following `Melon` class and `List` of `Melon`:

```
public class Melon {

    private final String type;
    private int weight;

    // constructors, getters, setters, equals(),
    // hashCode(), toString() omitted for brevity
}

List<Melon> melons = Arrays.asList(new Melon("Crenshaw", 1200),
    new Melon("Gac", 3000), new Melon("Hemi", 2600),
    new Melon("Hemi", 1600), new Melon("Gac", 1200),
    new Melon("Apollo", 2600), new Melon("Horned", 1700),
    new Melon("Gac", 3000), new Melon("Hemi", 2600));
```

Partitioning is done via `Collectors.partitioningBy()`. This method comes in two flavors, and one of them receives a single argument, that is, `partitioningBy(Predicate<? super T> predicate)`.

For example, partitioning melons by a weight of 2,000 g with duplicates can be done as follows:

```
Map<Boolean, List<Melon>> byWeight = melons.stream()
    .collect(partitioningBy(m -> m.getWeight() > 2000));
```

The output will be as follows:

```
{
  false=[Crenshaw(1200g),Hemi(1600g), Gac(1200g),Horned(1700g)],
  true=[Gac(3000g),Hemi(2600g),Apollo(2600g), Gac(3000g),Hemi(2600g)]
}
```



The advantage of partitioning over filtering consists of the fact that partitioning keeps both lists of the stream elements.

The following diagram depicts how `partitioningBy()` works internally:

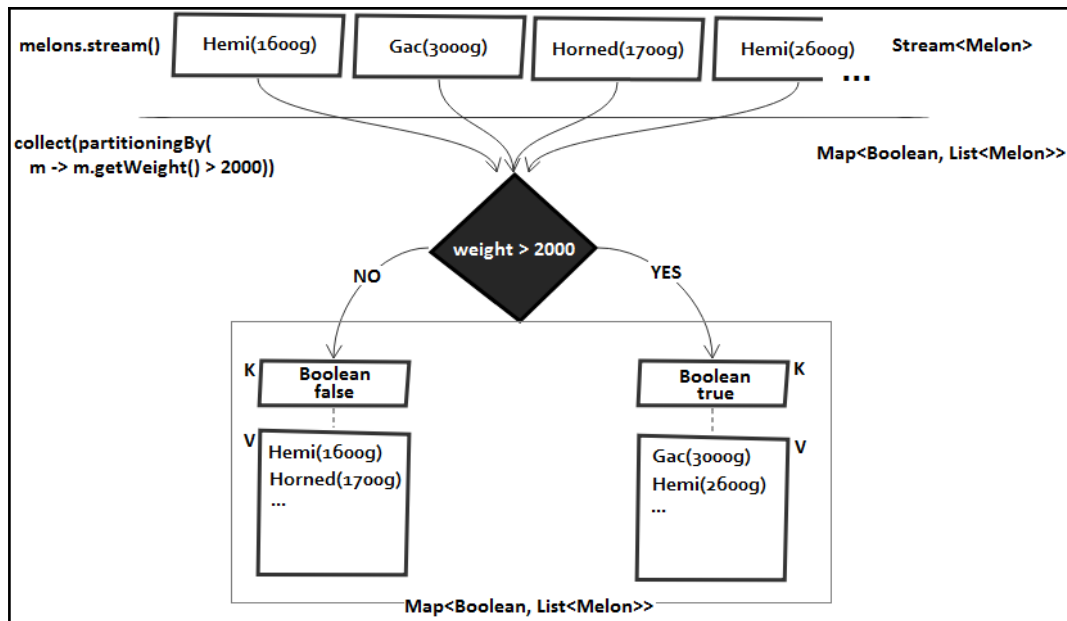

If we want to reject duplicates, then we can rely on other flavors of `partitioningBy()`, such as `partitioningBy(Predicate<? super T> predicate, Collector<? super T,A,D> downstream)`. The second argument allows us to specify another `Collector` for implementing the downstream reduction:

```
Map<Boolean, Set<Melon>> byWeight = melons.stream()
    .collect(partitioningBy(m -> m.getWeight() > 2000, toSet()));
```

The output will not contain duplicates:

```
{
  false=[Horned(1700g), Gac(1200g), Crenshaw(1200g), Hemi(1600g)],
  true=[Gac(3000g), Hemi(2600g), Apollo(2600g)]
}
```

Of course, in this case, `distinct()` will do the job as well:

```
Map<Boolean, List<Melon>> byWeight = melons.stream()
    .distinct()
    .collect(partitioningBy(m -> m.getWeight() > 2000));
```

Other collectors can be used as well. For example, we can count the elements from each of these two groups via `counting()`:

```
Map<Boolean, Long> byWeightAndCount = melons.stream()
    .collect(partitioningBy(m -> m.getWeight() > 2000, counting()));
```

The output will be as follows:

```
{false=4, true=5}
```

We can also count the elements without duplicates:

```
Map<Boolean, Long> byWeight = melons.stream()
    .distinct()
    .collect(partitioningBy(m -> m.getWeight() > 2000, counting()));
```

This time, the output will be as follows:

```
{false=4, true=3}
```

Finally, `partitioningBy()` can be combined with `collectingAndThen()`, which we introduced in the *Grouping* section. For example, let's partition the melons by weight of 2,000 g and keep only the heaviest from each partition:

```
Map<Boolean, Melon> byWeightMax = melons.stream()
    .collect(partitioningBy(m -> m.getWeight() > 2000,
        collectingAndThen(maxBy(comparingInt(Melon::getWeight)),
            Optional::get)));
```

The output will be as follows:

```
{false=Horned(1700g), true=Gac(3000g)}
```

191. Filtering, flattening, and mapping collectors

Let's assume that we have the following `Melon` class and `List` of `Melon`:

```
public class Melon {

    private final String type;
    private final int weight;
    private final List<String> pests;

    // constructors, getters, setters, equals(),
    // hashCode(), toString() omitted for brevity
}

List<Melon> melons = Arrays.asList(new Melon("Crenshaw", 2000),
    new Melon("Hemi", 1600), new Melon("Gac", 3000),
    new Melon("Hemi", 2000), new Melon("Crenshaw", 1700),
    new Melon("Gac", 3000), new Melon("Hemi", 2600));
```

The Java Stream API provides `filtering()`, `flatMaping()`, and `mapping()`, especially for use in multi-level reductions (such as the downstream of `groupingBy()` or `partitioningBy()`).

Conceptually, the goal of `filtering()` is the same as `filter()`, the goal of `flatMaping()` is the same as `flatMap()`, and the goal of `mapping()` is the same as `map()`.

filtering()

User problem: *I want to take all the melons that are heavier than 2,000 g and group them by their type. For each type, add them to the proper container (there is a container for each type – just check the container’s labels).*

By using `filtering(Predicate<? super T> predicate, Collector<? super T, A, R> downstream)`, we apply a predicate to each element of the current collector and accumulate the output in the downstream collector.

So, to group the melons that are heavier than 2,000 g by type, we can write the following stream pipeline:

```
Map<String, Set<Melon>> melonsFiltering = melons.stream()
    .collect(groupingBy(Melon::getType,
        filtering(m -> m.getWeight() > 2000, toSet())));
```

The output will be as follows (each `Set<Melon>` is a container):

```
{Crenshaw=[], Gac=[Gac(3000g)], Hemi=[Hemi(2600g)]}
```

Notice that there is no Crenshaw heavier than 2,000 g, so `filtering()` has mapped this type to an empty set (container). Now, let's rewrite this via `filter()`:

```
Map<String, Set<Melon>> melonsFiltering = melons.stream()
    .filter(m -> m.getWeight() > 2000)
    .collect(groupingBy(Melon::getType, toSet()));
```

Because `filter()` doesn't perform mappings for elements that fail its predicate, the output will look as follows:

```
{Gac=[Gac(3000g)], Hemi=[Hemi(2600g)]}
```

User problem: *This time, I am interested only in the melons of the Hemi type. There are two containers: one for Hemi melons lighter than (or equal to) 2,000 g and one for Hemi melons heavier than 2,000 g.*

Filtering can be used with `partitioningBy()` as well. To partition melons heavier than 2,000 g and filter them by a certain type (in this case, Hemi), we have the following:

```
Map<Boolean, Set<Melon>> melonsFiltering = melons.stream()
    .collect(partitioningBy(m -> m.getWeight() > 2000,
        filtering(m -> m.getType().equals("Hemi"), toSet())));
```

The output is as follows:

```
{false=[Hemi (1600g), Hemi (2000g)], true=[Hemi (2600g)]}
```

Applying `filter()` will lead to the same result:

```
Map<Boolean, Set<Melon>> melonsFiltering = melons.stream()
    .filter(m -> m.getType().equals("Hemi"))
    .collect(partitioningBy(m -> m.getWeight() > 2000, toSet()));
```

The output is as follows:

```
{false=[Hemi (1600g), Hemi (2000g)], true=[Hemi (2600g)]}
```

mapping()

User problem: *For each type of melon, I want the list of weights in ascending order.*

By using `mapping(Function<? super T, ? extends U> mapper, Collector<? super U, A, R> downstream)`, we can apply a mapping function to each element of the current collector and accumulate the output in the downstream collector.

For example, for grouping the weights of melons by type, we can write the following snippet of code:

```
Map<String, TreeSet<Integer>> melonsMapping = melons.stream()
    .collect(groupingBy(Melon::getType,
        mapping(Melon::getWeight, toCollection(TreeSet::new))));
```

The output will be as follows:

```
{Crenshaw=[1700, 2000], Gac=[3000], Hemi=[1600, 2000, 2600]}
```

User problem: *I want two lists. One should contain the melon types lighter than (or equal to) 2,000 g and the other one should contain the rest of the types.*

Partitioning melons that are heavier than 2,000 g and collecting only their types can be done as follows:

```
Map<Boolean, Set<String>> melonsMapping = melons.stream()
    .collect(partitioningBy(m -> m.getWeight() > 2000,
        mapping(Melon::getType, toSet())));
```

The output is as follows:

```
{false=[Crenshaw, Hemi], true=[Gac, Hemi]}
```

flatMap()

For a quick reminder about flattening a stream, it is advisable to read the *Map a stream* section.

Now, let's assume that we have the following list of `Melon` (notice that we've added the names of pests as well):

```
List<Melon> melonsGrown = Arrays.asList(
    new Melon("Honeydew", 5600,
        Arrays.asList("Spider Mites", "Melon Aphids", "Squash Bugs")),
    new Melon("Crenshaw", 2000,
        Arrays.asList("Pickleworms")),
    new Melon("Crenshaw", 1000,
        Arrays.asList("Cucumber Beetles", "Melon Aphids")),
    new Melon("Gac", 4000,
        Arrays.asList("Spider Mites", "Cucumber Beetles")),
    new Melon("Gac", 1000,
        Arrays.asList("Squash Bugs", "Squash Vine Borers")));
```

User problem: *For each type of melon, I want a list of their pests.*

So, let's group melons by type and collect their pests. Each melon has none, one, or multiple pests, and so we expect an output of the `Map<String, List<String>>` type. The first attempt will rely on `mapping()`:

```
Map<String, List<List<String>>> pests = melonsGrown.stream()
    .collect(groupingBy(Melon::getType,
        mapping(m -> m.getPests(), toList())));
```

Obviously, this is not a good approach since the returned type is `Map<String, List<List<String>>>`.

Another naive approach that relies on mapping is as follows:

```
Map<String, List<List<String>>> pests = melonsGrown.stream()
    .collect(groupingBy(Melon::getType,
        mapping(m -> m.getPests().stream(), toList())));
```

Obviously, this is not a good approach either since the returned type is `Map<String, List<Stream<String>>>`.

It's time to introduce `flatMap()`. By using `flatMap(Function<? super T,? extends Stream<? extends U>> mapper, Collector<? super U,A,R> downstream)`, we apply the `flatMap` function to each element of the current collector and accumulate the output in the downstream collector:

```
Map<String, Set<String>> pestsFlatMapping = melonsGrown.stream()
    .collect(groupingBy(Melon::getType,
        flatMapping(m -> m.getPests().stream(), toSet())));
```

This time, the type looks fine and the output is as follows:

```
{
  Crenshaw = [Cucumber Beetles, Pickleworms, Melon Aphids],
  Gac = [Cucumber Beetles, Squash Bugs, Spider Mites,
        Squash Vine Borers],
  Honeydew = [Squash Bugs, Spider Mites, Melon Aphids]
}
```

User problem: *I want two lists. One should contain the pests of melons lighter than 2,000 g, and the other should contain the pests of the rest of melons.*

Partitioning melons heavier than 2,000 g and collecting the pests can be done as follows:

```
Map<Boolean, Set<String>> pestsFlatMapping = melonsGrown.stream()
    .collect(partitioningBy(m -> m.getWeight() > 2000,
        flatMapping(m -> m.getPests().stream(), toSet())));
```

The output is as follows:

```
{
  false = [Cucumber Beetles, Squash Bugs, Pickleworms, Melon Aphids,
          Squash Vine Borers],
  true = [Squash Bugs, Cucumber Beetles, Spider Mites, Melon Aphids]
}
```

192. Teeing

Starting with JDK 12, we can merge the results of two collectors via `Collectors.teeing()`:

- `public static <T,R1,R2,R> Collector<T,?,R> teeing (Collector<? super T,?,R1> downstream1, Collector<? super T,?,R2> downstream2, BiFunction<? super R1,? super R2,R> merger):`



The result is a `Collector` that is a composite of two passed downstream collectors. Every element that's passed to the resulting collector is processed by both downstream collectors, and then their results are merged into the final result using the specified `BiFunction`.

Let's take a look at a classical problem. The following class simply stores the number of elements in a stream of integers and their sum:

```
public class CountSum {  
  
    private final Long count;  
    private final Integer sum;  
  
    public CountSum(Long count, Integer sum) {  
        this.count = count;  
        this.sum = sum;  
    }  
    ...  
}
```

We can obtain this information via `teeing()`, as follows:

```
CountSum countsum = Stream.of(2, 11, 1, 5, 7, 8, 12)  
    .collect(Collectors.teeing(  
        counting(),  
        summingInt(e -> e),  
        CountSum::new));
```

Here, we have applied two collectors to each element from the stream (`counting()` and `summingInt()`) and the results have been merged in an instance of `CountSum`:

```
CountSum{count=7, sum=46}
```

Let's take a look at another problem. This time, the `MinMax` class stores the minimum and maximum of a stream of integers:

```
public class MinMax {  
  
    private final Integer min;  
    private final Integer max;  
  
    public MinMax(Integer min, Integer max) {  
        this.min = min;  
        this.max = max;  
    }  
    ...  
}
```

Now, we can obtain this information like so:

```
MinMax minmax = Stream.of(2, 11, 1, 5, 7, 8, 12)  
    .collect(Collectors.teeing(  
        minBy(Comparator.naturalOrder()),  
        maxBy(Comparator.naturalOrder()),  
        (Optional<Integer> a, Optional<Integer> b)  
        -> new MinMax(a.orElse(Integer.MIN_VALUE),  
            b.orElse(Integer.MAX_VALUE))));
```

Here, we have applied two collectors to each element from the stream (`minBy()` and `maxBy()`) and the results have been merged in an instance of `MinMax`:

```
MinMax{min=1, max=12}
```

Finally, let's consider the following `Melon` class and `List of Melon`:

```
public class Melon {  
  
    private final String type;  
    private final int weight;  
  
    public Melon(String type, int weight) {  
        this.type = type;  
        this.weight = weight;  
    }  
    ...  
}
```

```
List<Melon> melons = Arrays.asList(new Melon("Crenshaw", 1200),
    new Melon("Gac", 3000), new Melon("Hemi", 2600),
    new Melon("Hemi", 1600), new Melon("Gac", 1200),
    new Melon("Apollo", 2600), new Melon("Horned", 1700),
    new Melon("Gac", 3000), new Melon("Hemi", 2600));
```

The aim here is to compute the total weight of these melons and list their weights. We can map this as follows:

```
public class WeightsAndTotal {

    private final int totalWeight;
    private final List<Integer> weights;

    public WeightsAndTotal(int totalWeight, List<Integer> weights) {
        this.totalWeight = totalWeight;
        this.weights = weights;
    }
    ...
}
```

The solution to this problem relies on `Collectors.teeing()`, as follows:

```
WeightsAndTotal weightsAndTotal = melons.stream()
    .collect(Collectors.teeing(
        summingInt(Melon::getWeight),
        mapping(m -> m.getWeight(), toList()),
        WeightsAndTotal::new));
```

This time, we have applied the `summingInt()` and `mapping()` collectors. The output is as follows:

```
WeightsAndTotal {
    totalWeight = 19500,
    weights = [1200, 3000, 2600, 1600, 1200, 2600, 1700, 3000, 2600]
}
```

193. Writing a custom collector

Let's assume that we have the following `Melon` class and `List of Melon`:

```
public class Melon {

    private final String type;
    private final int weight;
    private final List<String> grown;
```

```
// constructors, getters, setters, equals(),
// hashCode(), toString() omitted for brevity
}

List<Melon> melons = Arrays.asList(new Melon("Crenshaw", 1200),
    new Melon("Gac", 3000), new Melon("Hemi", 2600),
    new Melon("Hemi", 1600), new Melon("Gac", 1200),
    new Melon("Apollo", 2600), new Melon("Horned", 1700),
    new Melon("Gac", 3000), new Melon("Hemi", 2600));
```

In the *Partitioning* section, we saw how to use the `partitioningBy()` collector to partition melons that weigh 2,000 g with duplicates:

```
Map<Boolean, List<Melon>> byWeight = melons.stream()
    .collect(partitioningBy(m -> m.getWeight() > 2000));
```

Now, let's see if we can achieve the same result via a dedicated custom collector.

Let's begin by saying that writing a custom collector is not a day-to-day task, but it may be useful to know how to do it. The built-in `Java Collector` interface looks as follows:

```
public interface Collector<T, A, R> {
    Supplier<A> supplier();
    BiConsumer<A, T> accumulator();
    BinaryOperator<A> combiner();
    Function<A, R> finisher();
    Set<Characteristics> characteristics();
    ...
}
```

To write a custom collector, it is very important to know that `T`, `A`, and `R` represent the following:

- `T` represents the type of elements from the `Stream` (elements that will be collected).
- `A` represents the type of object that was used during the collection process known as the *accumulator*, which is used to accumulate the stream elements in a *mutable result container*.
- `R` represents the type of the object after the collection process (the final result).

A collector may return the accumulator itself as the final result or may perform an optional transformation on the accumulator to obtain the final result (perform an optional final transformation from the intermediate accumulation type, A , to the final result type, R).

In terms of our problem, we know that T is `Melon`, A is `Map<Boolean, List<Melon>>`, and R is `Map<Boolean, List<Melon>>`. This collector returns the accumulator itself as the final result via `Function.identity()`. That being said, we can start our custom collector as follows:

```
public class MelonCollector implements
    Collector<Melon, Map<Boolean, List<Melon>>,
        Map<Boolean, List<Melon>>> {
    ...
}
```

So, a `Collector` is specified by four functions. These functions are working together to accumulate entries into a mutable result container, and optionally perform a final transformation on the result. They are as follows:

- Creating a new empty mutable result container (`supplier()`)
- Incorporating a new data element into the mutable result container (`accumulator()`)
- Combining two mutable result containers into one (`combiner()`)
- Performing an optional final transformation on the mutable result container to obtain the final result (`finisher()`)

In addition, the behavior of the collector is defined in the last method, `characteristics().Set<Characteristics>` may contain the following four values:

- `UNORDERED`: The order of accumulating/collecting elements is not important for the final result.
- `CONCURRENT`: The elements of the stream can be accumulated by multiple threads in a concurrent fashion (in the end, the collector can perform a parallel reduction of the stream. The containers resulting from the parallel processing of the stream are combined in a single result container. The source of data should be unordered by its nature or the `UNORDERED` flag should be present.
- `IDENTITY_FINISH`: Indicates that the accumulator itself is the final result (basically, we can cast A to R); in this case, the `finisher()` is not called.

The supplier – `Supplier<A> supplier();`

The job of `supplier()` is to return (at every call) a `Supplier` of an empty mutable result container.

In our case, the result container is of the `Map<Boolean, List<Melon>>` type, and so `supplier()` can be implemented as follows:

```
@Override
public Supplier<Map<Boolean, List<Melon>>> supplier() {

    return () -> {
        return new HashMap<Boolean, List<Melon>> () {
            {
                put(true, new ArrayList<>());
                put(false, new ArrayList<>());
            }
        };
    };
}
```

In parallel execution, this method may be called multiple times.

Accumulating elements – `BiConsumer<A, T> accumulator();`

The `accumulator()` method returns the function that performs the reduction operation. This is `BiConsumer`, which is an operation that accepts two input arguments and returns no result. The first input argument is the current result container (being the result of the reduction so far), and the second input argument is the current element from the stream. This function modifies the result container itself by accumulating the traversed element or an effect of traversing this element. In our case, `accumulator()` adds the currently traversed element to one of the two `ArrayLists`:

```
@Override
public BiConsumer<Map<Boolean, List<Melon>>, Melon> accumulator() {

    return (var acc, var melon) -> {
        acc.get(melon.getWeight() > 2000).add(melon);
    };
}
```

Applying the final transformation – `Function<A, R> finisher()`;

The `finisher()` method returns a function that is applied at the end of the accumulation process. When this method is invoked, there are no more stream elements to traverse. All of the elements will be accumulated transformed from the intermediate accumulation type, `A`, to the final result type, `R`. If no transformation is needed, then we can return the intermediate result (the accumulator itself):

```
@Override
public Function<Map<Boolean, List<Melon>>,
    Map<Boolean, List<Melon>>> finisher() {

    return Function.identity();
}
```

Parallelizing the collector – `BinaryOperator<A> combiner()`;

If the stream is processed in parallel, then different threads (accumulators) will produce partial result containers. In the end, these partial results must be merged in a single one. This is exactly what `combiner()` does. In this case, the `combiner()` method needs to merge two maps by adding all the values from the two lists of the second `Map` to the corresponding lists in the first `Map`:

```
@Override
public BinaryOperator<Map<Boolean, List<Melon>>> combiner() {

    return (var map, var addMap) -> {
        map.get(true).addAll(addMap.get(true));
        map.get(false).addAll(addMap.get(false));

        return map;
    };
}
```

Returning the final result – `Function<A, R> finisher()`;

The final result is computed in the `finisher()` method. In this case, we simply return `Function.identity()` since the accumulator doesn't require any further transformation:

```
@Override
public Function<Map<Boolean, List<Melon>>,
    Map<Boolean, List<Melon>>> finisher() {

    return Function.identity();
}
```

Characteristics – `Set<Characteristics> characteristics()`;

Finally, we indicate that our collector is `IDENTITY_FINISH` and `CONCURRENT`:

```
@Override
public Set<Characteristics> characteristics() {
    return Set.of(IDENTITY_FINISH, CONCURRENT);
}
```

The code that's bundled with this book glues all the pieces of the puzzle together in a class named `MelonCollector`.

Testing time

`MelonCollector` can be used via the `new` keyword, as follows:

```
Map<Boolean, List<Melon>> melons2000 = melons.stream()
    .collect(new MelonCollector());
```

We will receive the following output:

```
{
  false = [Crenshaw(1200 g), Hemi(1600 g), Gac(1200 g), Horned(1700 g)],
  true = [Gac(3000 g), Hemi(2600 g), Apollo(2600 g),
    Gac(3000 g), Hemi(2600 g)]
}
```

We can also use it via `parallelStream()`:

```
Map<Boolean, List<Melon>> melons2000 = melons.parallelStream()
    .collect(new MelonCollector());
```

If we use the `combiner()` method, then the output may look as follows:

```
{false = [], true = [Hemi(2600g)]}
  ForkJoinPool.commonPool - worker - 7
...
{false = [Horned(1700g)], true = []}
  ForkJoinPool.commonPool - worker - 15
{false = [Crenshaw(1200g)], true = [Gac(3000g)]}
  ForkJoinPool.commonPool - worker - 9
...
{false = [Crenshaw(1200g), Hemi(1600g), Gac(1200g), Horned(1700g)],
 true = [Gac(3000g), Hemi(2600g), Apollo(2600g),
        Gac(3000g), Hemi(2600g)]}
```

Custom collecting via `collect()`

In the case of an `IDENTITY_FINISH` collection operation, there is at least one more solution for obtaining a custom collector. This solution is facilitated by the following method:

```
<R> R collect(Supplier<R> supplier, BiConsumer<R,? super T>
    accumulator, BiConsumer<R,R> combiner)
```

This flavor of `collect()` is a great fit as long as we deal with an `IDENTITY_FINISH` collection operation and we can provide a supplier, accumulator, and combiner.

Let's take a look at some examples:

```
List<String> numbersList = Stream.of("One", "Two", "Three")
    .collect(ArrayList::new, ArrayList::add,
        ArrayList::addAll);

Deque<String> numbersDeque = Stream.of("One", "Two", "Three")
    .collect(ArrayDeque::new, ArrayDeque::add,
        ArrayDeque::addAll);

String numbersString = Stream.of("One", "Two", "Three")
    .collect(StringBuilder::new, StringBuilder::append,
        StringBuilder::append).toString();
```

You can use these examples to identify more JDK classes whose signatures are well-suited for use with method references as arguments to `collect()`.

194. Method reference

Let's assume that we have the following `Melon` class and `List of Melon`:

```
public class Melon {

    private final String type;
    private int weight;

    public static int growing100g(Melon melon) {
        melon.setWeight(melon.getWeight() + 100);

        return melon.getWeight();
    }

    // constructors, getters, setters, equals(),
    // hashCode(), toString() omitted for brevity
}

List<Melon> melons = Arrays.asList(
    new Melon("Crenshaw", 1200), new Melon("Gac", 3000),
    new Melon("Hemi", 2600), new Melon("Hemi", 1600));
```

In a nutshell, *method references* are shortcuts for lambda expressions.

Mainly, method reference is a technique that's used to call a method by name rather than by a description of how to call it. The main benefit is readability.

A method reference is written by placing the target reference before the delimiter, `::`, and the name of the method is provided after it.

We'll take a look at all four kinds of method references in the upcoming sections.

Method reference to a static method

We can group each `Melon` from the aforementioned list that's 100 g via the static method called `growing100g()`:

- No method reference:

```
melons.forEach(m -> Melon.growing100g(m));
```

- Method reference:

```
melons.forEach(Melon::growing100g);
```

Method reference to an instance method

Let's assume that we are defining the following Comparator for Melon:

```
public class MelonComparator implements Comparator {  
  
    @Override  
    public int compare(Object m1, Object m2) {  
        return Integer.compare(((Melon) m1).getWeight(),  
            ((Melon) m2).getWeight());  
    }  
}
```

Now, we can refer to it as follows:

- No method reference:

```
MelonComparator mc = new MelonComparator();  
  
List<Melon> sorted = melons.stream()  
    .sorted((Melon m1, Melon m2) -> mc.compare(m1, m2))  
    .collect(Collectors.toList());
```

- Method reference:

```
List<Melon> sorted = melons.stream()  
    .sorted(mc::compare)  
    .collect(Collectors.toList());
```

Of course, we can call `Integer.compare()` directly as well:

- No method reference:

```
List<Integer> sorted = melons.stream()  
    .map(m -> m.getWeight())  
    .sorted((m1, m2) -> Integer.compare(m1, m2))  
    .collect(Collectors.toList());
```

- Method reference:

```
List<Integer> sorted = melons.stream()
    .map(m -> m.getWeight())
    .sorted(Integer::compare)
    .collect(Collectors.toList());
```

Method reference to a constructor

Referring a constructor can be done via the `new` keyword, as follows:

```
BiFunction<String, Integer, Melon> melonFactory = Melon::new;
Melon hemi1300 = melonFactory.apply("Hemi", 1300);
```

More details and examples about method reference to a constructor are available in the *Implementing the factory pattern* section in the previous chapter.

195. Parallel processing of streams

In a nutshell, parallel processing a stream refers to a process that consists of three steps:

1. Splitting the elements of a stream into multiple chunks
2. Processing each chunk in a separate thread
3. Joining the results of processing in a single result

These three steps take place behind the scenes via the default `ForkJoinPool` method as we discussed in Chapter 10, *Concurrency – Thread Pools, Callables, and Synchronizers* and Chapter 11, *Concurrency – Deep Dive*.

As a rule of thumb, parallel processing can be applied only to *stateless* (the state of an element doesn't affect another element), *non-interfering* (the data source is not affected), and *associative* (the result is not affected by the order of operands) operations.

Let's assume that our problem is to sum the elements of a list of doubles:

```
Random rnd = new Random();
List<Double> numbers = new ArrayList<>();

for (int i = 0; i < 1_000_000; i++) {
    numbers.add(rnd.nextDouble());
}
```

We can also do this directly as a stream:

```
DoubleStream.generate(() -> rnd.nextDouble()).limit(1_000_000)
```

In a sequential approach, we can do this as follows:

```
double result = numbers.stream()
    .reduce((a, b) -> a + b).orElse(-1d);
```

This operation will probably take place on a single core behind the scenes (even if our machine has more cores), as shown in the following diagram:

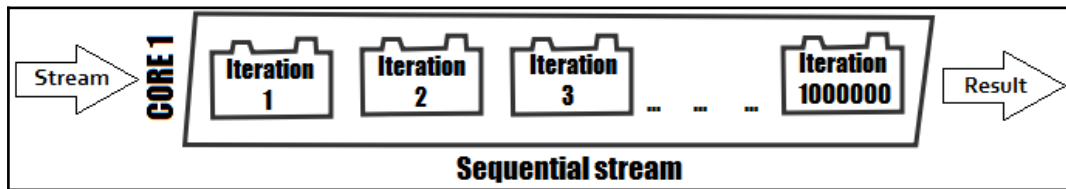

This problem is a good candidate for leverage parallelization, and so we can call `parallelStream()` instead of `stream()`, as follows:

```
double result = numbers.parallelStream()
    .reduce((a, b) -> a + b).orElse(-1d);
```

Once we call `parallelStream()`, Java will take action and process the stream using multiple threads. Parallelization can be done via the `parallel()` method as well:

```
double result = numbers.stream()
    .parallel()
    .reduce((a, b) -> a + b).orElse(-1d);
```

This time, the processing takes place via a fork/join, as shown in the following diagram (there is one thread for each available core):

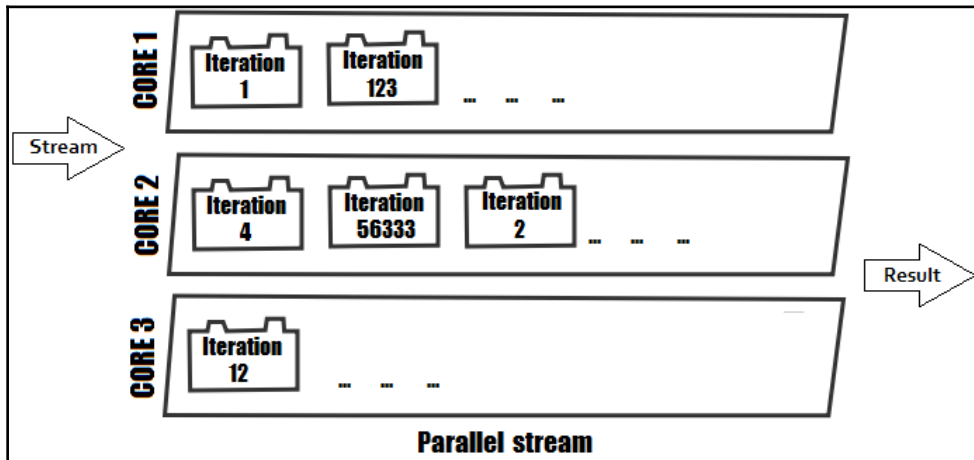

In the context of `reduce()`, parallelization can be depicted as follows:

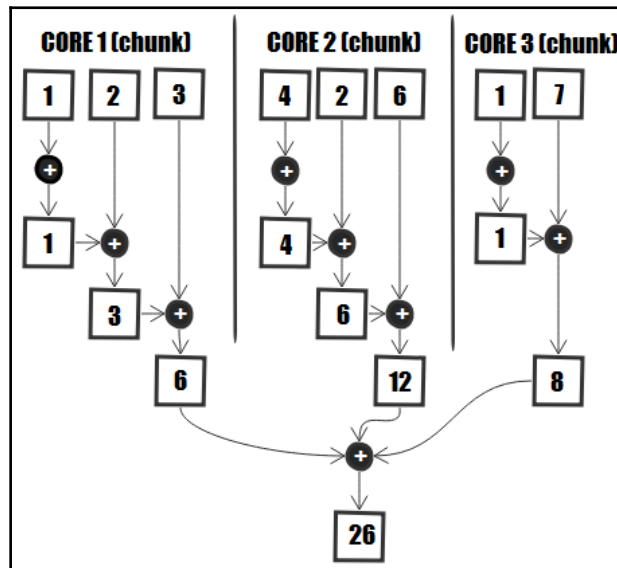

By default, the Java `ForkJoinPool` will try to fetch as many threads as available processors like so:

```
int noOfProcessors = Runtime.getRuntime().availableProcessors();
```

We can affect the number of threads globally (all the parallel streams will use it) as follows:

```
System.setProperty(
    "java.util.concurrent.ForkJoinPool.common.parallelism", "10");
```

Alternatively, we can affect the number of threads for a single parallel stream as follows:

```
ForkJoinPool customThreadPool = new ForkJoinPool(5);

double result = customThreadPool.submit(
    () -> numbers.parallelStream()
        .reduce((a, b) -> a + b)).get().orElse(-1d);
```

Affecting the number of threads is an important decision to make. Trying to determine the optimal number of threads depending on the environment is not an easy task and, in most scenarios, the default setting (*number of threads = number of processors*) is the most suitable.



Even if the problem is a good candidate for leverage parallelization, it doesn't mean that parallel processing is a silver bullet. Deciding to go with parallel processing or not should be a decision that's made after benchmarking and comparing sequential versus parallel processing. Most commonly, parallel processing acts better in the case of huge datasets.

Do not fall into the trap of thinking that a larger number of threads results in faster processing. Avoid something like the following (these numbers are just indicators for a machine with 8 cores):

```
5 threads (~40 ms)
20 threads (~50 ms)
100 threads (~70 ms)
1000 threads (~ 250 ms)
```

Spliterators

A Java `Spliterator` interface (also known as a *splittable iterator*) is an interface that's used to traverse the elements of a source (for example, a collection or stream) in parallel. This interface defines the following methods:

```
public interface Spliterator<T> {
    boolean tryAdvance(Consumer<? super T> action);
    Spliterator<T> trySplit();
    long estimateSize();
    int characteristics();
}
```

Let's consider a simple list of 10 integers:

```
List<Integer> numbers = Arrays.asList(1, 2, 3, 4, 5, 6, 7, 8, 9, 10);
```

We can obtain a `Spliterator` interface for this list like so:

```
Spliterator<Integer> s1 = numbers.spliterator();
```

We can also do the same from a stream:

```
Spliterator<Integer> s1 = numbers.stream().spliterator();
```

In order to advance to (traverse) the first element, we need to call the `tryAdvance()` method, as follows:

```
s1.tryAdvance(e
    -> System.out.println("Advancing to the
        first element of s1: " + e));
```

We will receive the following output:

```
Advancing to the first element of s1: 1
```

`Spliterator` can try to estimate the number of elements left to traverse via the `estimateSize()` method, as follows:

```
System.out.println("\nEstimated size of s1: " + s1.estimateSize());
```

We will receive the following output (we've traversed one element; there are nine to go):

```
Estimated size of s1: 9
```

We can split this into two via a `Splitterator` interface using the `trySplit()` method. The result will be another `Splitterator` interface:

```
Splitterator<Integer> s2 = s1.trySplit();
```

Checking the number of elements reveals the effect of `trySplit()`:

```
System.out.println("Estimated size s1: " + s1.estimateSize());
System.out.println("Estimated size s2: " + s2.estimateSize());
```

We will receive the following output:

```
Estimated size s1: 5
Estimated size s2: 4
```

Trying to print all the elements from `s1` and `s2` can be accomplished using `forEachRemaining()`, as follows:

```
s1.forEachRemaining(System.out::println); // 6, 7, 8, 9, 10
s2.forEachRemaining(System.out::println); // 2, 3, 4, 5
```

A `Splitterator` interface defines a suite of constants for its characteristics – `CONCURRENT` (4096), `DISTINCT` (1), `IMMUTABLE` (1024), `NONNULL` (256), `ORDERED` (16), `SIZED` (64), `SORTED` (4), and `SUBSIZED` (16384).

We can print the characteristics via the `characteristics()` method as follows:

```
System.out.println(s1.characteristics()); // 16464
System.out.println(s2.characteristics()); // 16464
```

It is simpler to test whether a certain characteristic is presented using `hasCharacteristics()`:

```
if (s1.hasCharacteristics(Splitterator.ORDERED)) {
    System.out.println("ORDERED");
}

if (s1.hasCharacteristics(Splitterator.SIZED)) {
    System.out.println("SIZED");
}
```

Writing a custom Spliterator

Obviously, writing a custom `Spliterator` is not a daily task, but let's assume that we are working on a project that, for some reason, requires us to process strings that contain ideographic characters (**CJKV** (short for **C**hinese, **J**apanese, **K**orean, and **V**ietnamese)) and non-ideographic characters. We want to process these strings in parallel. This mandates that we split them into characters only at positions representing ideographic characters.

Obviously, the default `Spliterator` will not perform as we want it to, and so we may need to write a custom `Spliterator`. For this, we have to implement the `Spliterator` interface and provide an implementation of a few methods. The implementation is available in the code that's been bundled with this book. Consider opening the `IdeographicSpliterator` source code and keeping it close by while reading the rest of this section.

The climax of the implementation is in the `trySplit()` method. Here, we are trying to split the current string in half and continue to traverse it until we find an ideographic character. For checking purposes, we've just added the following line:

```
System.out.println("Split successfully at character: "
    + str.charAt(splitPosition));
```

Now, let's consider a string containing ideographic characters:

```
String str = "Character Information 字 Development and Maintenance "
    + "Project 盤 for e-Government MojiJoho-Kiban 事 Project";
```

Now, let's create a parallel stream for this string and force `IdeographicSpliterator` to do its job:

```
Spliterator<Character> spliterator = new IdeographicSpliterator(str);
Stream<Character> stream = StreamSupport.stream(spliterator, true);

// force spliterator to do its job
stream.collect(Collectors.toList());
```

One possible output will reveal that the split takes place only at positions containing ideographic characters:

```
Split successfully at character: 盤
Split successfully at character: 事
```

196. Null-safe streams

The problem with creating a `Stream` of an element that may or may not be `null` can be solved using `Optional.ofNullable()` or, even better via JDK 9, `Stream.ofNullable()`:

- `static <T> Stream<T> ofNullable(T t)`

This method gets a single element (`T`) and returns a sequential `Stream` containing this single element (`Stream<T>`); otherwise, it returns an empty `Stream` if it's not `null`.

For example, we can write a helper method that wraps the call to `Stream.ofNullable()` as follows:

```
public static <T> Stream<T> elementAsStream(T element) {
    return Stream.ofNullable(element);
}
```

If this method lives in a utility class named `AsStreams`, then we can perform several calls, as follows:

```
// 0
System.out.println("Null element: "
    + AsStreams.elementAsStream(null).count());

// 1
System.out.println("Non null element: "
    + AsStreams.elementAsStream("Hello world").count());
```

Notice that when we pass `null`, we get an empty stream (the `count()` method returns 0)!

If our element is a collection, then things become more interesting. For example, let's assume that we have the following list (notice that this list contains some `null` values):

```
List<Integer> ints = Arrays.asList(5, null, 6, null, 1, 2);
```

Now, let's write a helper method that returns a `Stream<T>`, where `T` is a collection:

```
public static <T> Stream<T> collectionAsStreamWithNulls(
    Collection<T> element) {
    return Stream.ofNullable(element).flatMap(Collection::stream);
}
```

If we call this method with `null`, then we obtain an empty stream:

```
// 0
System.out.println("Null collection: "
    + AsStreams.collectionAsStreamWithNulls(null).count());
```

Now, if we call it with our list, `ints`, then we obtain a `Stream<Integer>`:

```
// 6
System.out.println("Non-null collection with nulls: "
    + AsStreams.collectionAsStreamWithNulls(ints).count());
```

Notice that the stream has six elements (all the elements from the underlying list)—5, null, 6, null, 1, and 2.

If we know that the collection itself is not `null`, but it may contain `null` values, then we can write another helper method, as follows:

```
public static <T> Stream<T> collectionAsStreamWithoutNulls(
    Collection<T> collection) {

    return collection.stream().flatMap(e -> Stream.ofNullable(e));
}
```

This time, if the collection itself is `null`, then the code will throw an `NullPointerException`. However, if we pass our list to it, then the result will be a `Stream<Integer>` without `null` values:

```
// 4
System.out.println("Non-null collection without nulls: "
    + AsStreams.collectionAsStreamWithoutNulls(ints).count());
```

The returned stream has only four elements—5, 6, 1, and 2.

Finally, if the collection itself may be `null` and may contain `null` values, then the following helper will do the job and return a `null`-safe stream:

```
public static <T> Stream<T> collectionAsStream(
    Collection<T> collection) {

    return Stream.ofNullable(collection)
        .flatMap(Collection::stream)
        .flatMap(Stream::ofNullable);
}
```

If we pass null, then we get an empty stream:

```
// 0
System.out.println(
    "Null collection or non-null collection with nulls: "
    + AsStreams.collectionAsStream(null).count());
```

If we pass our list, we get a `Stream<Integer>` stream without null values:

```
// 4
System.out.println(
    "Null collection or non-null collection with nulls: "
    + AsStreams.collectionAsStream(ints).count());
```

197. Composing functions, predicates, and comparators

Composing (or chaining) functions, predicates, and comparators allows us to write compound criteria that should be applied in unison.

Composing predicates

Let's assume that we have the following `Melon` class and `List of Melon`:

```
public class Melon {

    private final String type;
    private final int weight;

    // constructors, getters, setters, equals(),
    // hashCode(), toString() omitted for brevity
}

List<Melon> melons = Arrays.asList(new Melon("Gac", 2000),
    new Melon("Horned", 1600), new Melon("Apollo", 3000),
    new Melon("Gac", 3000), new Melon("Hemi", 1600));
```

The `Predicate` interface comes with three methods that take a `Predicate` and uses it to obtain an enriched `Predicate`. These methods are `and()`, `or()`, and `negate()`.

For example, let's assume that we want to filter the melons that are heavier than 2,000 g. For this, we can write a `Predicate`, as follows:

```
Predicate<Melon> p2000 = m -> m.getWeight() > 2000;
```

Now, let's assume that we want to enrich this `Predicate` to filter only melons that respect `p2000` and are of the `Gac` or `Apollo` type. For this, we can use the `and()` and `or()` methods, as follows:

```
Predicate<Melon> p2000GacApollo  
= p2000.and(m -> m.getType().equals("Gac"))  
    .or(m -> m.getType().equals("Apollo"));
```

This is interpreted from left to rights as a `&& (b || c)`, where we have the following:

- a is `m -> m.getWeight() > 2000`
- b is `m -> m.getType().equals("Gac")`
- c is `m -> m.getType().equals("Apollo")`

Obviously, we can add more criteria in the same manner.

Let's pass this `Predicate` to `filter()`:

```
// Apollo(3000g), Gac(3000g)  
List<Melon> result = melons.stream()  
    .filter(p2000GacApollo)  
    .collect(Collectors.toList());
```

Now, let's assume that our problem requires that we obtain the negation of the aforementioned compound predicate. It is cumbersome to rewrite this predicate as `!a && !b && !c` or any other counterpart expression. A better solution is to call the `negate()` method, as follows:

```
Predicate<Melon> restOf = p2000GacApollo.negate();
```

Let's pass it to `filter()`:

```
// Gac(2000g), Horned(1600g), Hemi(1600g)  
List<Melon> result = melons.stream()  
    .filter(restOf)  
    .collect(Collectors.toList());
```

Starting with JDK 11, we can negate a `Predicate` that's passed as an argument to the `not()` method. For example, let's filter all the melons that are lighter than (or equal to) 2,000 g using `not()`:

```
Predicate<Melon> pNot2000 = Predicate.not(m -> m.getWeight() > 2000);

// Gac(2000g), Horned(1600g), Hemi(1600g)
List<Melon> result = melons.stream()
    .filter(pNot2000)
    .collect(Collectors.toList());
```

Composing comparators

Let's consider the same `Melon` class and `List` of `Melon` from the preceding section.

Now, let's sort this `List` of `Melon` by weight using `Comparator.comparing()`:

```
Comparator<Melon> byWeight = Comparator.comparing(Melon::getWeight);

// Horned(1600g), Hemi(1600g), Gac(2000g), Apollo(3000g), Gac(3000g)
List<Melon> sortedMelons = melons.stream()
    .sorted(byWeight)
    .collect(Collectors.toList());
```

We can sort the list by type as well:

```
Comparator<Melon> byType = Comparator.comparing(Melon::getType);

// Apollo(3000g), Gac(2000g), Gac(3000g), Hemi(1600g), Horned(1600g)
List<Melon> sortedMelons = melons.stream()
    .sorted(byType)
    .collect(Collectors.toList());
```

To reverse the sorting order, simply call `reversed()`:

```
Comparator<Melon> byWeight
    = Comparator.comparing(Melon::getWeight).reversed();
```

So far, so good!

Now, let's assume that we want to sort the list by weight and type. In other words, when two melons have the same weight (for example, Horned (1600g), Hemi (1600g)) they should be sorted by type (for example, Hemi (1600g), Horned (1600g)). A naive approach will look as follows:

```
// Apollo(3000g), Gac(2000g), Gac(3000g), Hemi(1600g), Horned(1600g)
List<Melon> sortedMelons = melons.stream()
    .sorted(byWeight)
    .sorted(byType)
    .collect(Collectors.toList());
```

Obviously, the result is not what we expected. This is happening because the comparators have not been applied to the same list. The `byWeight` comparator is applied to the original list, while the `byType` comparator is applied to the output of `byWeight`. Basically, `byType` cancels the effect of `byWeight`.

The solution comes from the `Comparator.thenComparing()` method. This method allows us to chain comparators:

```
Comparator<Melon> byWeightAndType
    = Comparator.comparing(Melon::getWeight)
    .thenComparing(Melon::getType);

// Hemi(1600g), Horned(1600g), Gac(2000g), Apollo(3000g), Gac(3000g)
List<Melon> sortedMelons = melons.stream()
    .sorted(byWeightAndType)
    .collect(Collectors.toList());
```

This flavor of `thenComparing()` takes a `Function` as an argument. This `Function` is used to extract the `Comparable` sort key. The returned `Comparator` is applied only when the previous `Comparator` has found two equal objects.

Another flavor of `thenComparing()` gets a `Comparator`:

```
Comparator<Melon> byWeightAndType =
    Comparator.comparing(Melon::getWeight)
    .thenComparing(Comparator.comparing(Melon::getType));
```

Finally, let's consider the following `List` of `Melon`:

```
List<Melon> melons = Arrays.asList(new Melon("Gac", 2000),
    new Melon("Horned", 1600), new Melon("Apollo", 3000),
    new Melon("Gac", 3000), new Melon("hemi", 1600));
```

We intentionally added a mistake to the last `Melon`. Its type is lowercase this time. If we apply the `byWeightAndType` comparator, then the output will be as follows:

```
Horned(1600g), hemi(1600g), ...
```

Being a lexicographic-order comparator, `byWeightAndType` will place `Horned` before `hemi`. So, it will be useful to sort by type in a case-insensitive manner. An elegant solution to this problem will rely on another flavor of `thenComparing()`, which allows us to pass a `Function` and `Comparator` as arguments. The `Function` that is passed extracts the `Comparable` sort key, and the given `Comparator` is used to compare this sort key:

```
Comparator<Melon> byWeightAndType =
    Comparator.comparing(Melon::getWeight)
        .thenComparing(Melon::getType, String.CASE_INSENSITIVE_ORDER);
```

This time, the result will be as follows (we are back on track):

```
hemi(1600g), Horned(1600g), ...
```



For `int`, `long`, and `double`, we have `comparingInt()`, `comparingLong()`, `comparingDouble()`, `thenComparingInt()`, `thenComparingLong()`, and `thenComparingDouble()`. The `comparing()` and `thenComparing()` methods come with the same flavors.

Composing functions

Lambda expressions that are represented via the `Function` interface can be composed via the `Function.andThen()` and `Function.compose()` methods.

`andThen(Function<? super R, ? extends V> after)` returns a composed `Function` that does the following:

- Applies this function to its input
- Applies the `after` function to the result

Let's take a look at an example of this:

```
Function<Double, Double> f = x -> x * 2;
Function<Double, Double> g = x -> Math.pow(x, 2);
Function<Double, Double> gf = f.andThen(g);
double resultgf = gf.apply(4d); // 64.0
```

In this example, the f function is applied to its input (4). The result of applying f is 8 ($f(4) = 4 * 2$). This result is the input of the second function, g . The result of applying g is 64 ($g(8) = \text{Math.pow}(8, 2)$). The following diagram depicts the flow for four inputs – 1, 2, 3, and 4:

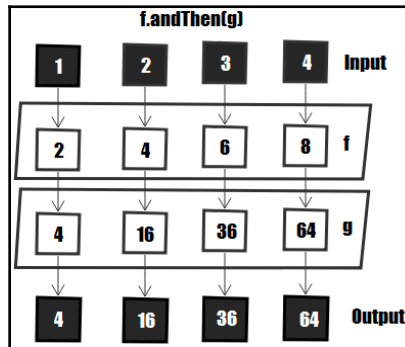

So, this is like $g(f(x))$. The opposite, $f(g(x))$, can be shaped using `Function.compose()`. The returned composed function applies the *before function* to its input, and then applies *this function* to the result:

```
double resultfg = fg.apply(4d); // 32.0
```

In this example, the g function is applied to its input (4). The result of applying g is 16 ($g(4) = \text{Math.pow}(4, 2)$). This result is the input of the second function, f . The result of applying f is 32 ($f(16) = 16 * 2$). The following diagram depicts the flow for four inputs – 1, 2, 3, and 4:

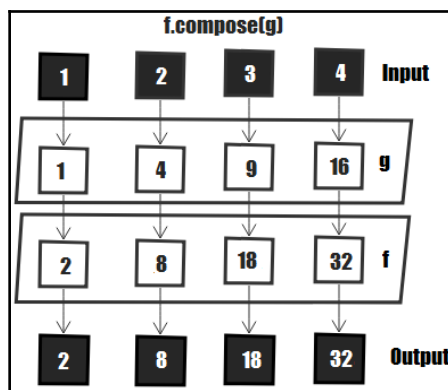

Based on the same principles, we can develop an application for editing an article by composing the `addIntroduction()`, `addBody()`, and `addConclusion()` methods. Please take a look at the code that's bundled with this book to see an implementation of this.

We can write other pipelines as well by simply juggling this with the composition process.

198. Default methods

Default methods were added to Java 8. Their main goal is to provide support for interfaces so that they can evolve beyond an abstract contract (contain only abstract methods). This facility is very useful for people that write libraries and want to evolve APIs in a compatible way. Via default methods, an interface can be enriched without disrupting existing implementations.

A default method is implemented directly in the interface and is recognized by the `default` keyword.

For example, the following interface defines an abstract method called `area()` and a default method called `perimeter()`:

```
public interface Polygon {  
  
    public double area();  
  
    default double perimeter(double...segments) {  
        return Arrays.stream(segments)  
            .sum();  
    }  
}
```

Since the perimeter of all common polygons (for example, squares) is the sum of the edges, we can implement it here. On the other hand, the area formula differs from polygon to polygon, and so a default implementation will not be very useful.

Now, let's define a `Square` class that implements `Polygon`. Its goal is to express the area of a square via the perimeter:

```
public class Square implements Polygon {  
  
    private final double edge;  
  
    public Square(double edge) {
```

```
        this.edge = edge;
    }

    @Override
    public double area() {
        return Math.pow(perimeter(edge, edge, edge, edge) / 4, 2);
    }
}
```

Other polygons (for example, rectangles and triangles) can implement `Polygon` and express the area based on the perimeter that's computed via the default implementation.

However, in certain cases, we may need to override the default implementation of a default method. For example, the `Square` class may override the `perimeter()` method, as follows:

```
@Override
public double perimeter(double...segments) {
    return segments[0] * 4;
}
```

We can call it as follows:

```
@Override
public double area() {
    return Math.pow(perimeter(edge) / 4, 2);
}
```

Summary

Our job's done! This chapter covered infinite streams, null-safe streams, and default methods. A comprehensive list of problems covered grouping, partitioning, and collectors, including the JDK 12 `teeing()` collector and writing a custom collector. In addition, `takeWhile()`, `dropWhile()`, composing functions, predicates and comparators, testing and debugging lambdas, and other cool topics were covered as well.

Download the applications from this chapter to view the results and additional details.

10

Concurrency - Thread Pools, Callables, and Synchronizers

This chapter includes 14 problems that involve Java concurrency. We will start with several fundamental problems about thread life cycles and object- and class-level locking. We then continue with a bunch of problems about thread pools in Java including the JDK 8 work-stealing thread pool. After that, we have problems dedicated to `Callable` and `Future`. Then, we dedicate several problems to Java synchronizers (for example, barrier, semaphore, and exchanger). By the end of this chapter, you should be familiar with the main coordinates of Java concurrency and be ready to continue with a set of advanced problems.

Problems

Use the following problems to test your concurrency programming prowess. I strongly encourage you to give each problem a try before you turn to the solutions and download the example programs:

199. **Thread life cycle states:** Write several programs that capture each life cycle state of a thread.
200. **Object- versus class-level locking:** Write several examples that exemplify object- versus class-level locking via thread synchronization.
201. **Thread pools in Java:** Provide a brief overview of thread pools in Java.
202. **Thread pool with a single thread:** Write a program that simulates an assembly line for checking and packing up bulbs using two workers.
203. **Thread pool with a fixed number of threads:** Write a program that simulates an assembly line for checking and packing up bulbs using multiple workers.

204. **Cached and scheduled thread pools:** Write a program that simulates an assembly line for checking and packing up bulbs using workers as needed (for example, adapt the number of packers (increase or decrease) to ingest the incoming flux produced by the checker).
205. **Work-stealing thread pool:** Write a program that relies on a work-stealing thread pool. More precisely, write a program that simulates an assembly line for checking and packing up bulbs as follows: checking takes place during the day, and packing takes place at night. The checking process results in a queue of 15 million bulbs every day.
206. **Callable and Future:** Write a program that simulates an assembly line for checking and packing up bulbs using `Callable` and `Future`.
207. **Invoking multiple Callable tasks:** Write a program that simulates an assembly line for checking and packing up bulbs as follows: checking takes place during the day, and packing takes place at night. The checking process results in a queue of 100 bulbs every day. The packing process should pack and return all the bulbs at once. In other words, we should submit all `Callable` tasks and wait for all of them to complete.
208. **Latches:** Write a program that relies on `CountDownLatch` to simulate the process of starting a server. The server is considered started after its internal services have started. Services can be started concurrently and are independent of each other.
209. **Barriers:** Write a program that relies on `CyclicBarrier` to simulate the process of starting a server. The server is considered started after its internal services have started. Services can be prepared for start concurrently (this is time-consuming), but they run interdependently – therefore, once they are ready to start, they must be started all at once.
210. **Exchangers:** Write a program that simulates using `Exchanger`, an assembly line for checking and packing up bulbs using two workers. A worker (the checker) is checking bulbs and adding them in a basket. When the basket is full, the worker gives it to the other worker (the packer) from whom they receive an empty basket. The process repeats until the assembly line stops.
211. **Semaphores:** Write a program that simulates using one `Semaphore` per day at the barbershop. Mainly, our barbershop can serve a maximum of three people at a time (it has only three seats). When a person arrives at the barbershop, they try to take a seat. After they are served by a barber, the person releases the seat. If a person arrives at the barbershop when all three seats are taken, they must wait for a certain amount of time. If this time elapses and no seats have been freed, they will leave the barbershop.

212. **Phasers:** Write a program that relies on `Phaser` to simulate the process of starting a server in three phases. The server is considered started after its five internal services have started. At the first phase, we need to concurrently start three services. At the second phase, we need to concurrently start two more two services (these can be started only if the first three are already running). At phase three, the server performs a final check-in and is considered started.

Solutions

The following sections describe solutions to the preceding problems. Remember that there usually isn't just one correct way to solve a particular problem. Also, remember that the explanations shown here include only the most interesting and important details needed to solve the problems. Download the example solutions to see additional details and to experiment with the programs at <https://github.com/PacktPublishing/Java-Coding-Problems>.

199. Thread life cycle states

The states of a Java thread are expressed via the `Thread.State` enumeration. The possible states of a Java thread are shown in the following diagram:

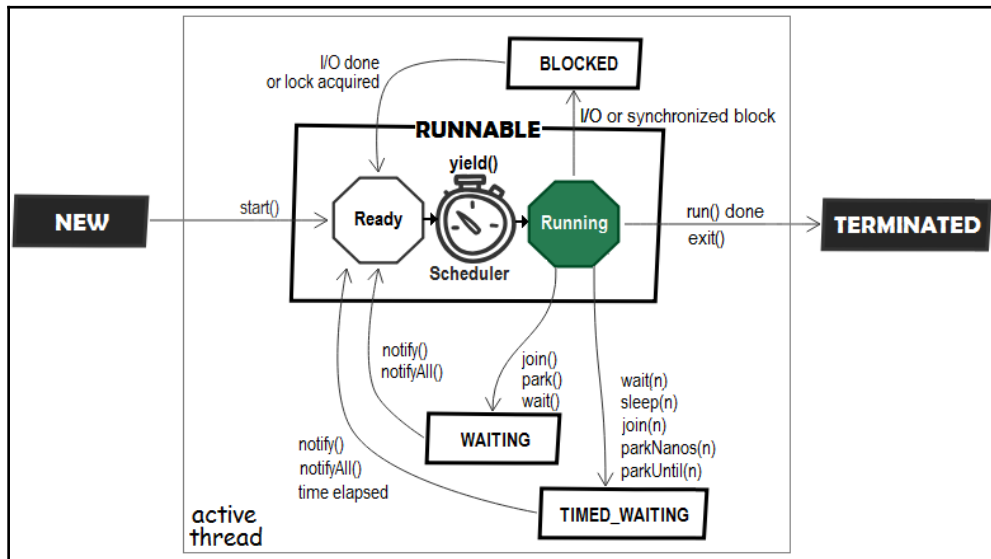

The different lifecycle states are as follows:

- The **NEW** state
- The **RUNNABLE** state
- The **BLOCKED** state
- The **WAITING** state
- The **TIMED_WAITING** state
- The **TERMINATED** state

Let's learn about all the different states in the following sections.

The NEW state

A Java thread is in the **NEW** state if it is created but not started (the thread constructor creates threads in the **NEW** state). This is its state until the `start()` method is invoked. The code bundled with this book contains several snippets of code that reveal this state via different construction techniques, including lambdas. For brevity, the following is just one of these constructions:

```
public class NewThread {

    public void newThread() {
        Thread t = new Thread(() -> {});
        System.out.println("NewThread: " + t.getState()); // NEW
    }
}

NewThread nt = new NewThread();
nt.newThread();
```

The RUNNABLE state

The transition from **NEW** to **RUNNABLE** is obtained by calling the `start()` method. In this state, a thread can be running or ready to run. When it is ready to run, a thread is waiting for the JVM thread-scheduler to allocate the needed resources and time to run to it. As soon as the processor is available, the thread-scheduler will run the thread.

The following snippet of code should print **RUNNABLE**, since we print the state of the thread after calling `start()`. But because of thread-scheduler internal mechanisms, this is not guaranteed:

```
public class RunnableThread {

    public void runnableThread() {
        Thread t = new Thread(() -> {});
        t.start();

        // RUNNABLE
        System.out.println("RunnableThread : " + t.getState());
    }
}

RunnableThread rt = new RunnableThread();
rt.runnableThread();
```

The **BLOCKED** state

When a thread is trying to execute I/O tasks or synchronized blocks, it may enter into the **BLOCKED** state. For example, if a thread, `t1`, tries to enter into a synchronized block of code that is already being accessed by another thread, `t2`, then `t1` is kept in the **BLOCKED** state until it can acquire the lock.

This scenario is shaped in the following snippet of code:

1. Create two threads: `t1` and `t2`.
2. Start `t1` via the `start()` method:
 1. `t1` will execute the `run()` method and will acquire the lock for the synchronized method, `syncMethod()`.
 2. The `syncMethod()` will keep `t1` inside forever, since it has an infinite loop.
3. After two seconds (arbitrary time), start `t2` via the `start()` method:
 1. `t2` will execute the `run()` code and will end up in the **BLOCKED** state since it cannot acquire the lock of `syncMethod()`.

The code snippet is as follows:

```
public class BlockedThread {

    public void blockedThread() {
```

```
Thread t1 = new Thread(new SyncCode());
Thread t2 = new Thread(new SyncCode());

t1.start();
Thread.sleep(2000);
t2.start();
Thread.sleep(2000);

System.out.println("BlockedThread t1: "
    + t1.getState() + "(" + t1.getName() + ")");
System.out.println("BlockedThread t2: "
    + t2.getState() + "(" + t2.getName() + ")");

System.exit(0);
}

private static class SyncCode implements Runnable {

    @Override
    public void run() {
        System.out.println("Thread " + Thread.currentThread().getName()
            + " is in run() method");
        syncMethod();
    }

    public static synchronized void syncMethod() {
        System.out.println("Thread " + Thread.currentThread().getName()
            + " is in syncMethod() method");

        while (true) {
            // t1 will stay here forever, therefore t2 is blocked
        }
    }
}

BlockedThread bt = new BlockedThread();
bt.blockedThread();
```

Here is a possible output (the names of threads may differ from here):

```
Thread Thread-0 is in run() method
Thread Thread-0 is in syncMethod() method
Thread Thread-1 is in run() method
BlockedThread t1: RUNNABLE(Thread-0)
BlockedThread t2: BLOCKED(Thread-1)
```

The WAITING state

A thread, `t1`, that waits (without a timeout period) for another thread, `t2`, to finish is in the **WAITING** state.

This scenario is shaped in the following snippet of code:

1. Create a thread: `t1`.
2. Start `t1` via the `start()` method.
3. In the `run()` method of `t1`:
 1. Create another thread: `t2`.
 2. Start `t2` via the `start()` method.
 3. While `t2` is running, call `t2.join()`—since `t2` needs to join `t1` (or, in other words, `t1` needs to wait for `t2` to die), `t1` is in the **WAITING** state.
4. In the `run()` method of `t2`, `t2` prints the state of `t1`, which should be **WAITING** (while printing the `t1` state, `t2` is running, therefore `t1` is waiting).

The code snippet is as follows:

```
public class WaitingThread {

    public void waitingThread() {
        new Thread(() -> {
            Thread t1 = Thread.currentThread();
            Thread t2 = new Thread(() -> {

                Thread.sleep(2000);
                System.out.println("WaitingThread t1: "
                    + t1.getState()); // WAITING
            });

            t2.start();

            t2.join();

        }).start();
    }
}

WaitingThread wt = new WaitingThread();
wt.waitingThread();
```

The `TIMED_WAITING` state

A thread, `t1`, that waits for an explicit period of time for another thread, `t2`, to finish is in the `TIMED_WAITING` state.

This scenario is shaped in the following snippet of code:

1. Create a thread: `t1`.
2. Start `t1` via the `start()` method.
3. In the `run()` method of `t1`, add a sleep time of two seconds (arbitrary time).
4. While `t1` is running, the main thread prints the `t1` state—the state should be `TIMED_WAITING` since `t1` is in a `sleep()` that will expire after two seconds.

The code snippet is as follows:

```
public class TimedWaitingThread {

    public void timedWaitingThread() {
        Thread t = new Thread(() -> {
            Thread.sleep(2000);
        });

        t.start();

        Thread.sleep(500);

        System.out.println("TimedWaitingThread t: "
            + t.getState()); // TIMED_WAITING
    }
}

TimedWaitingThread twt = new TimedWaitingThread();
twt.timedWaitingThread();
```

The TERMINATED state

A thread that successfully finishes its job or is abnormally interrupted is in the **TERMINATE** state. This is very simple to simulate, as in the following snippet of code (the main thread of the application prints the state of the thread, `t`—when this is happening, the thread, `t`, has done its job):

```
public class TerminatedThread {

    public void terminatedThread() {
        Thread t = new Thread(() -> {});
        t.start();

        Thread.sleep(1000);

        System.out.println("TerminatedThread t: "
            + t.getState()); // TERMINATED
    }
}

TerminatedThread tt = new TerminatedThread();
tt.terminatedThread();
```

In order to write thread-safe classes, we can consider the following techniques:

- Have no *state* (classes with no instance and `static` variables)
- Have *state*, but don't share it (for example, use instance variables via `Runnable`, `ThreadLocal`, and so on)
- Have *state*, but an immutable *state*
- Use message-passing (for example, as Akka framework)
- Use `synchronized` blocks
- Use `volatile` variables
- Use data structures from the `java.util.concurrent` package
- Use synchronizers (for example, `CountDownLatch` and `Barrier`)
- Use locks from the `java.util.concurrent.locks` package

200. Object- versus class-level locking

In Java, a block of code marked as `synchronized` can be executed by a single thread at a time. Since Java is a multi-threaded environment (it supports concurrency), it needs a synchronization mechanism to avoid issues specific to concurrent environments (for example, deadlocks and memory consistency).

A thread can achieve locks at the object level or at the class level.

Locking at the object level

Locking at object level can be achieved by marking a `non-static` block of code or `non-static` method (the lock object for that method's object) with `synchronized`. In the following examples, only one thread at a time will be allowed to execute the `synchronized` method/block on the given instance of the class:

- Synchronized method case:

```
public class Class011 {
    public synchronized void method011() {
        ...
    }
}
```

- Synchronized block of code:

```
public class Class011 {
    public void method011() {
        synchronized(this) {
            ...
        }
    }
}
```

- Another synchronized block of code:

```
public class Class011 {

    private final Object o11Lock = new Object();
    public void method011() {
        synchronized(o11Lock) {
            ...
        }
    }
}
```

Lock at the class level

In order to protect `static` data, locking at the class level can be achieved by marking a `static` method/block or acquiring a lock on the `.class` reference with `synchronized`. In the following examples, only one thread of one of the available instances at runtime will be allowed to execute the `synchronized` block at a time:

- `synchronized static method`:

```
public class ClassC11 {  
    public synchronized static void methodC11() {  
        ...  
    }  
}
```

- `Synchronized block and lock on .class`:

```
public class ClassC11 {  
    public void method() {  
        synchronized(ClassC11.class) {  
            ...  
        }  
    }  
}
```

- `Synchronized block of code and lock on some other static object`:

```
public class ClassC11 {  
    private final static Object aLock = new Object();  
    public void method() {  
        synchronized(aLock) {  
            ...  
        }  
    }  
}
```

Good to know

Here are some common cases that imply synchronizations:

- Two threads can execute concurrently a `synchronized static` method and a `non-static` method of the same class (see the `OLLAndCll` class of the `P200_ObjectVsClassLevelLocking` app). This works because the threads acquire locks on different objects.
- Two threads cannot concurrently execute two different `synchronized static` methods (or the same `synchronized static` method) of the same class (check the `TwoCll` class of the `P200_ObjectVsClassLevelLocking` application). This does not work because the first thread acquires a class-level lock. The following combinations will output, `staticMethod1(): Thread-0`, therefore, only one `static synchronized` method is executed by only one thread:

```
TwoCll instance1 = new TwoCll();
TwoCll instance2 = new TwoCll();
```

- Two threads, two instances:

```
new Thread(() -> {
    instance1.staticMethod1();
}).start();

new Thread(() -> {
    instance2.staticMethod2();
}).start();
```

- Two threads, one instance:

```
new Thread(() -> {
    instance1.staticMethod1();
}).start();

new Thread(() -> {
    instance1.staticMethod2();
}).start();
```

- Two threads can concurrently execute `non-synchronized`, `synchronized static`, and `synchronized non-static` methods (check the `OLLc11AndNoLock` class of the `P200_ObjectVsClassLevelLocking` application).

- It is safe to call a synchronized method from another synchronized method of the same class that requires the same lock. This works because synchronized is *re-entrant* (as long as it is the same lock, the lock acquired for the first method is used in the second method as well). Check the `TwoSyncs` class of the `P200_ObjectVsClassLevelLocking` application.



As a rule of thumb, the `synchronized` keyword can be used only with `static/non-static methods (not constructors)/code blocks`. Avoid synchronizing `non-final fields and String literals` (instances of `String` created via `new` are OK).

201. Thread pools in Java

A thread pool is a collection of threads that can be used to execute tasks. A thread pool is responsible for managing the creation, allocation, and life cycles of its threads and contributing to better performance. Now, let's talk about executors.

Executor

In the `java.util.concurrent` package, there are a bunch of interfaces dedicated to executing tasks. The simplest one is named `Executor`. This interface exposes a single method named `execute(Runnable command)`. Here is an example of executing a single task using this method:

```
public class SimpleExecutor implements Executor {

    @Override
    public void execute(Runnable r) {
        (new Thread(r)).start();
    }
}

SimpleExecutor se = new SimpleExecutor();

se.execute(() -> {
    System.out.println("Simple task executed via Executor interface");
});
```

ExecutorService

A more complex and comprehensive interface that provides many additional methods is `ExecutorService`. This is an enriched version of `Executor`. Java comes with a fully-fledged implementation of `ExecutorService`, named `ThreadPoolExecutor`. This is a thread pool that can be instantiated with a bunch of arguments, as follows:

```
ThreadPoolExecutor(  
    int corePoolSize,  
    int maximumPoolSize,  
    long keepAliveTime,  
    TimeUnit unit,  
    BlockingQueue<Runnable> workQueue,  
    ThreadFactory threadFactory,  
    RejectedExecutionHandler handler)
```

Here is a short description of each of the arguments instantiated in the preceding code:

- `corePoolSize`: The number of threads to keep in the pool, even if they are idle (unless `allowCoreThreadTimeOut` is set)
- `maximumPoolSize`: The maximum number of allowed threads
- `keepAliveTime`: When this time has elapsed, the idle threads will be removed from the pool (these are idle threads that exceed `corePoolSize`)
- `unit`: The time unit for the `keepAliveTime` argument
- `workQueue`: A queue for holding the instances of `Runnable` (only the `Runnable` tasks submitted by the `execute()` method) before they are executed
- `threadFactory`: This factory is used when the executor creates a new thread
- `handler`: When `ThreadPoolExecutor` cannot execute a `Runnable` due to saturation, this is when the thread bounds and queue capacities are full (for example, `workQueue` has a fixed size and `maximumPoolSize` is set as well)—it gives the control and decision to this handler

In order to optimize the pool size, we need to collect the following information:

- Number of CPUs (`Runtime.getRuntime().availableProcessors()`)
- Target CPU utilization (in range, [0, 1])

- Wait time (W)
- Compute time (C)

The following formula helps us to determine the optimal size of the pool:

$$\text{Number of threads} = \text{Number of CPUs} * \text{Target CPU utilization} * (1 + W/C)$$



As a rule of thumb, for compute-intensive tasks (usually small tasks), it can be a good idea to benchmark the thread pool with the number of threads equal with to number of processors or number of processors + 1 (to prevent potential pauses). For time-consuming and blocking tasks (for example, I/O), a larger pool is better since threads will not be available for scheduling at a high rate. Also, pay attention to interferences with other pools (for example, database connections pools, and socket connection pools).

Let's see an example of `ThreadPoolExecutor`:

```
public class SimpleThreadPoolExecutor implements Runnable {

    private final int taskId;

    public SimpleThreadPoolExecutor(int taskId) {
        this.taskId = taskId;
    }

    @Override
    public void run() {
        Thread.sleep(2000);
        System.out.println("Executing task " + taskId
            + " via " + Thread.currentThread().getName());
    }

    public static void main(String[] args) {

        BlockingQueue<Runnable> queue = new LinkedBlockingQueue<>(5);
        final AtomicInteger counter = new AtomicInteger();

        ThreadFactory threadFactory = (Runnable r) -> {
            System.out.println("Creating a new Cool-Thread-"
                + counter.incrementAndGet());

            return new Thread(r, "Cool-Thread-" + counter.get());
        };

        RejectedExecutionHandler rejectedHandler
```

```
    = (Runnable r, ThreadPoolExecutor executor) -> {
        if (r instanceof SimpleThreadPoolExecutor) {
            SimpleThreadPoolExecutor task=(SimpleThreadPoolExecutor) r;
            System.out.println("Rejecting task " + task.taskId);
        }
    };

    ThreadPoolExecutor executor = new ThreadPoolExecutor(10, 20, 1,
        TimeUnit.SECONDS, queue, threadFactory, rejectedHandler);

    for (int i = 0; i < 50; i++) {
        executor.execute(new SimpleThreadPoolExecutor(i));
    }

    executor.shutdown();
    executor.awaitTermination(
        Integer.MAX_VALUE, TimeUnit.MILLISECONDS);
}
}
```

The `main()` method fires 50 instances of `Runnable`. Each `Runnable` sleeps for two seconds and prints a message. The work queue is limited to five instances of `Runnable`—the core threads to 10, the maximum number of threads to 20, and the idle timeout to one second. A possible output will look as follows:

```
Creating a new Cool-Thread-1
...
Creating a new Cool-Thread-20
Rejecting task 25
...
Rejecting task 49
Executing task 22 via Cool-Thread-18
...
Executing task 12 via Cool-Thread-2
```

ScheduledExecutorService

`ScheduledExecutorService` is an `ExecutorService` that can schedule tasks for execution after a given delay, or execute periodically. Here, we have methods such as `schedule()`, `scheduleAtFixedRate()`, and `scheduleWithFixedDelay()`. While `schedule()` is used for one-shot tasks, `scheduleAtFixedRate()` and `scheduleWithFixedDelay()` are used for periodic tasks.

Thread pools via Executors

One step further, and we introduce the helper class, `Executors`. This class exposes several types of thread pools using the following methods:

- `newSingleThreadExecutor()`: This is a thread pool that manages only one thread with an unbounded queue, which only executes one task at a time:

```
ExecutorService executor
    = Executors.newSingleThreadExecutor();
```

- `newCachedThreadPool()`: This is a thread pool that creates new threads and removes idle threads (after 60 seconds) as they are needed; the core pool size is 0 and the maximum pool size is `Integer.MAX_VALUE` (this thread pool expands when demand increases and contracts when demand decreases):

```
ExecutorService executor = Executors.newCachedThreadPool();
```

- `newFixedThreadPool()`: This is a thread pool with a fixed number of threads and an unbounded queue, which creates the effect of an infinite timeout (the core pool size and the maximum pool size are equal to the specified size):

```
ExecutorService executor = Executors.newFixedThreadPool(5);
```

- `newWorkStealingThreadPool()`: This a thread pool based on a work-stealing algorithm (it acts as a layer over a fork/join framework):

```
ExecutorService executor = Executors.newWorkStealingPool();
```

- `newScheduledThreadPool()`: A thread pool that can schedule commands to run after a given delay, or to execute periodically (we can specify the core pool size):

```
ScheduledExecutorService executor
    = Executors.newScheduledThreadPool(5);
```

202. Thread pool with a single thread

In order to show how a thread pool with a single thread works, let's assume that we want to write a program that simulates an assembly line (or a conveyor) for checking and packing up bulbs using two workers.

By *checking*, we understand that the worker tests if the bulb lights up or not. By *packing*, we understand that the worker takes the verified bulb and put it in a box. This kind of process is very common in almost any factory.

The two workers are as follows:

- A so-called producer (or checker) that is responsible for testing each bulb to see if the bulb lights up or not
- A so-called consumer (or packer) that is responsible for packing each checked bulb into a box

This kind of problem is a perfect fit for the producer-consumer design pattern shown in the following diagram:

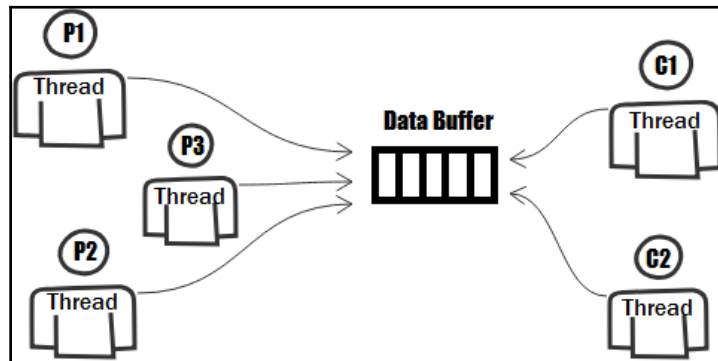

Most commonly, in this pattern, the producer and consumer communicate via a queue (the producer enqueues data, and the consumer dequeues data). This queue is known as the *data buffer*. Of course, depending on the process design, other data structures can play the role of data buffer as well.

Now, let's see how we can implement this pattern if the producer waits for the consumer to be available.

Later on, we will implement this pattern for a producer that doesn't wait for a consumer.

Producer waits for the consumer to be available

When the assembly line starts, the producer will check the incoming bulbs one by one, while the consumer will pack them (one bulb into each box). This flow repeats until the assembly line stops.

The following diagram is a graphical representation of this flow between the **producer** and the **consumer**:

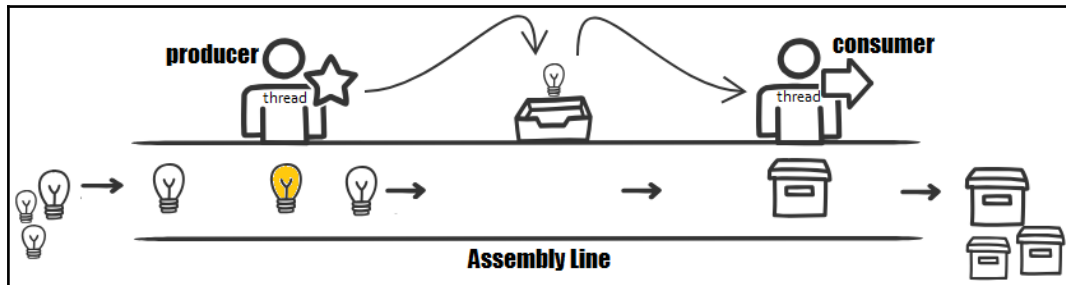

We can consider the assembly line a helper of our factory, therefore it can be implemented as a helper or utility class (of course, it can be easily switched to a non-static implementation as well, so feel free to do the switch if it makes more sense for your cases):

```
public final class AssemblyLine {  
  
    private AssemblyLine() {  
        throw new AssertionError("There is a single assembly line!");  
    }  
    ...  
}
```

Of course, there are many ways to implement this scenario, but we are interested in using the `Java ExecutorService`, more precisely `Executors.newSingleThreadExecutor()`. An `Executor` that uses a single worker thread operating off of an unbounded queue is created by this method.

We have only two workers, so we can use two instances of `Executor` (an `Executor` will power up the producer, and another one will power up the consumer). So, the producer will be a thread, and the consumer will be another thread:

```
private static ExecutorService producerService;  
private static ExecutorService consumerService;
```

Since the producer and the consumer are good friends, they decide to work based on a simple scenario:

- The producer will check a bulb and pass it to the consumer only if the consumer is not busy (if the consumer is busy, the producer will wait a while until the consumer is free)
- The producer will not check the next bulb until they manage to pass the current bulb to the consumer
- The consumer will pack each incoming bulb as soon as possible

This scenario works well for `TransferQueue` or `SynchronousQueue`, which carries out a process very similar to the aforementioned scenario. Let's use `TransferQueue`. This is a `BlockingQueue` in which the producers may wait for the consumers to receive elements. `BlockingQueue` implementations are thread-safe:

```
private static final TransferQueue<String> queue  
    = new LinkedTransferQueue<>();
```

The workflow between producer and consumer is of the **First In First Out** type (**FIFO**: the first bulb checked is the first bulb packed) therefore `LinkedTransferQueue` can be a good choice.

Once the assembly line starts, the producer will continuously check bulbs, therefore we can implement it as a class as follows:

```
private static final int MAX_PROD_TIME_MS = 5 * 1000;  
private static final int MAX_CONS_TIME_MS = 7 * 1000;  
private static final int TIMEOUT_MS = MAX_CONS_TIME_MS + 1000;  
private static final Random rnd = new Random();  
private static volatile boolean runningProducer;  
...  
private static class Producer implements Runnable {  
  
    @Override  
    public void run() {  
        while (runningProducer) {  
            try {  
                String bulb = "bulb-" + rnd.nextInt(1000);
```

```
        Thread.sleep(rnd.nextInt(MAX_PROD_TIME_MS));

        boolean transfered = queue.tryTransfer(bulb,
            TIMEOUT_MS, TimeUnit.MILLISECONDS);

        if (transfered) {
            logger.info(() -> "Checked: " + bulb);
        }
    } catch (InterruptedException ex) {
        Thread.currentThread().interrupt();
        logger.severe(() -> "Exception: " + ex);
        break;
    }
}
}
```

So, the producer transfers a checked bulb to the consumer via the `tryTransfer()` method. If it is possible to transfer the elements to a consumer before the timeout elapses, this method will do so.



Avoid using the `transfer()` method, which may block the thread indefinitely.

In order to simulate the time spent by the producer checking a bulb, the corresponding thread will sleep a random number of seconds between 0 and 5 (5 seconds is the maximum time needed to check a bulb). If the consumer is not available after this time, more time will be spent (in `tryTransfer()`) until the consumer is available or the timeout elapses.

On the other hand, the consumer is implemented using another class, as follows:

```
private static volatile boolean runningConsumer;
...
private static class Consumer implements Runnable {

    @Override
    public void run() {
        while (runningConsumer) {
            try {
                String bulb = queue.poll(
                    MAX_PROD_TIME_MS, TimeUnit.MILLISECONDS);

                if (bulb != null) {
                    Thread.sleep(rnd.nextInt(MAX_CONS_TIME_MS));
                }
            }
        }
    }
}
```

```
        logger.info(() -> "Packed: " + bulb);
    }
} catch (InterruptedException ex) {
    Thread.currentThread().interrupt();
    logger.severe(() -> "Exception: " + ex);
    break;
}
}
}
}
```

The consumer may take a bulb from the producer via the `queue.take()` method. This method retrieves and removes the head of this queue, waiting, if necessary, until a bulb becomes available. Or it may call the `poll()` method, in which the head of the queue is retrieved and removed, or if this queue is empty it returns `null`. But neither of these two is right for us. If the producer is not available, the consumer may remain stuck in the `take()` method. On the other hand, if the queue is empty (the producer is checking the current bulb right now), the `poll()` method will be called again and again very quickly, causing a dummy repetition. The solution to this is `poll(long timeout, TimeUnit unit)`. This method retrieves and removes the head of this queue and waits up to the specified wait time, if required, for a bulb to become available. It will return `null` only if the queue is empty after the waiting time has elapsed.

In order to simulate the time the consumer spends packing a bulb, the corresponding thread will sleep a random number of seconds between 0 and 7 (7 seconds is the maximum time needed for packing a bulb).

Starting the producer and the consumer is a very simple task accomplished in a method named `startAssemblyLine()`, as follows:

```
public static void startAssemblyLine() {

    if (runningProducer || runningConsumer) {
        logger.info("Assembly line is already running ...");
        return;
    }

    logger.info("\n\nStarting assembly line ...");
    logger.info(() -> "Remaining bulbs from previous run: \n"
        + queue + "\n\n");

    runningProducer = true;
    producerService = Executors.newSingleThreadExecutor();
    producerService.execute(producer);
}
```

```
    runningConsumer = true;
    consumerService = Executors.newSingleThreadExecutor();
    consumerService.execute(consumer);
}
```

Stopping the assembly line is a delicate process that can be tackled via different scenarios. Mainly, when the assembly line is stopped, the producer should check the current bulb as the last bulb and the consumer must pack it. It is possible that the producer will have to wait for the consumer to pack their current bulb before they can transfer the last bulb; further, the consumer must pack this bulb as well.

In order to follow this scenario, we stop the producer first and the consumer second:

```
public static void stopAssemblyLine() {

    logger.info("Stopping assembly line ...");

    boolean isProducerDown = shutdownProducer();
    boolean isConsumerDown = shutdownConsumer();

    if (!isProducerDown || !isConsumerDown) {
        logger.severe("Something abnormal happened during
            shutting down the assembling line!");

        System.exit(0);
    }

    logger.info("Assembling line was successfully stopped!");
}

private static boolean shutdownProducer() {
    runningProducer = false;
    return shutdownExecutor(producerService);
}

private static boolean shutdownConsumer() {
    runningConsumer = false;
    return shutdownExecutor(consumerService);
}
```

Finally, we give enough time to the producer and consumer to stop normally (without the interruption of threads). This takes place in the `shutdownExecutor()` method, as follows:

```
private static boolean shutdownExecutor(ExecutorService executor) {

    executor.shutdown();
```

```
try {
    if (!executor.awaitTermination(TIMEOUT_MS * 2,
        TimeUnit.MILLISECONDS)) {
        executor.shutdownNow();
        return executor.awaitTermination(TIMEOUT_MS * 2,
            TimeUnit.MILLISECONDS);
    }

    return true;
} catch (InterruptedException ex) {
    executor.shutdownNow();
    Thread.currentThread().interrupt();
    logger.severe(() -> "Exception: " + ex);
}

return false;
}
```

The first thing that we do is set the `runningProducer` static variable to `false`. This will break `while(runningProducer)`, therefore this will be the last bulb checked. Further, we initiate the shutdown procedure for the producer.

In the case of a consumer, the first thing that we do is set the `runningConsumer` static variable to `false`. This will break `while(runningConsumer)`, therefore this will be the last bulb packed. Further, we initiate the shutdown procedure for the consumer.

Let's see a possible execution of the assembly line (run it for 10 seconds):

```
AssemblyLine.startAssemblyLine();
Thread.sleep(10 * 1000);
AssemblyLine.stopAssemblyLine();
```

A possible output will be as follows:

```
Starting assembly line ...
...
[2019-04-14 07:39:40] [INFO] Checked: bulb-89
[2019-04-14 07:39:43] [INFO] Packed: bulb-89
...
Stopping assembly line ...
...
[2019-04-14 07:39:53] [INFO] Packed: bulb-322
Assembling line was successfully stopped!
```



Generally speaking, if it takes a lot of time to stop the assembly line (it acts as if it were blocked), then there's probably an unbalanced rate between the number of producers and consumers and/or between the production and consumption times. You may need to add or subtract producers or consumers.

Producer doesn't wait for the consumer to be available

If the producer can check bulbs faster than the consumer can pack them, then most probably they will decide to have the following workflow:

- The producer will check bulbs one by one and push them in a queue
- The consumer will poll from the queue and pack the bulbs

Since the consumer is slower than the producer, the queue will hold checked but unpacked bulbs (we may assume that there is a low chance to have an empty queue). In the following diagram, we have the producer, the consumer, and the queue used for storing checked but unpacked bulbs:

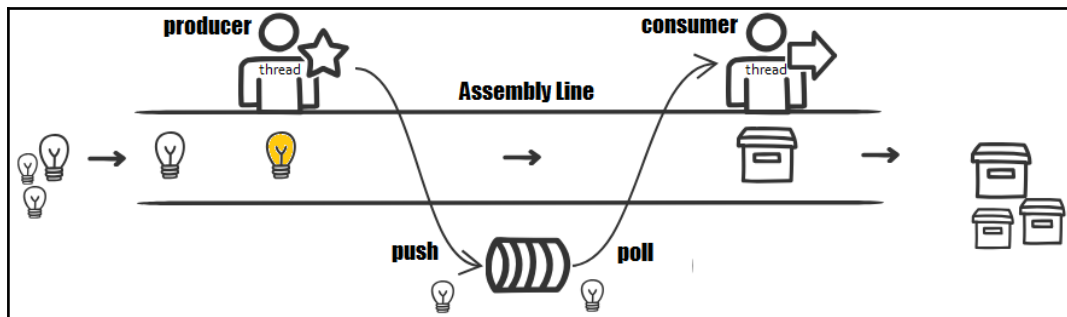

In order to shape this scenario, we can rely on `ConcurrentLinkedQueue` (or `LinkedBlockingQueue`). This is an unbounded thread-safe queue based on linked nodes:

```
private static final Queue<String> queue
    = new ConcurrentLinkedQueue<>();
```

In order to push a bulb in the queue, the producer calls the `offer()` method:

```
queue.offer(bulb);
```

On the other hand, the consumer processes bulbs from the queue using the `poll()` method (since the consumer is slower than the producer, it should be a rare case when `poll()` will return `null`):

```
String bulb = queue.poll();
```

Let's start the assembly line for the first time for 10 seconds. This will output the following:

```
Starting assembly line ...
...
[2019-04-14 07:44:58] [INFO] Checked: bulb-827
[2019-04-14 07:44:59] [INFO] Checked: bulb-257
[2019-04-14 07:44:59] [INFO] Packed: bulb-827
...
Stopping assembly line ...
...
[2019-04-14 07:45:08] [INFO] Checked: bulb-369
[2019-04-14 07:45:09] [INFO] Packed: bulb-690
...
Assembling line was successfully stopped!
```

At this point, the assembly line is stopped, and in the queue, we have the following (these bulbs have been checked, but not packed):

```
[bulb-968, bulb-782, bulb-627, bulb-886, ...]
```

We restart the assembly line and check the highlighted lines, which reveal that the consumer resumes its job from where they'd stopped:

```
Starting assembly line ...
[2019-04-14 07:45:12] [INFO ] Packed: bulb-968
[2019-04-14 07:45:12] [INFO ] Checked: bulb-812
[2019-04-14 07:45:12] [INFO ] Checked: bulb-470
[2019-04-14 07:45:14] [INFO ] Packed: bulb-782
[2019-04-14 07:45:15] [INFO ] Checked: bulb-601
[2019-04-14 07:45:16] [INFO ] Packed: bulb-627
...
```

203. Thread pool with a fixed number of threads

This problem reiterates the scenario from the *Thread pool with a single thread* section. This time, the assembly line uses three producers and two consumers, as in the following diagram:

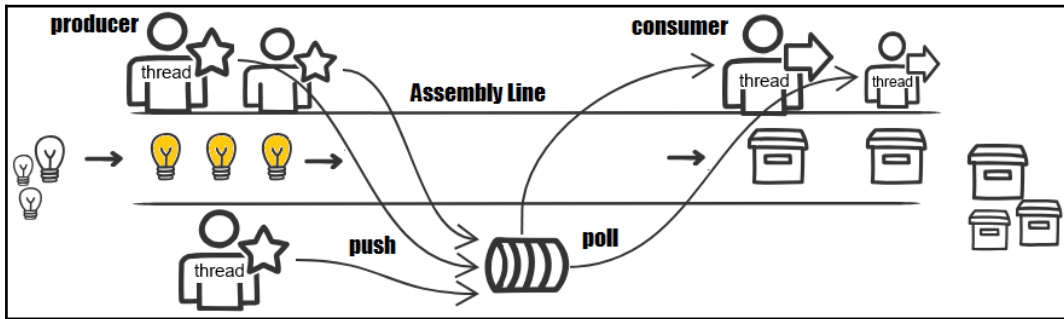

We can rely on `Executors.newFixedThreadPool(int nThreads)` to simulate the fixed number of producers and consumers. We allocate one thread per producer (respectively, consumer), therefore the code is pretty simple:

```
private static final int PRODUCERS = 3;
private static final int CONSUMERS = 2;
private static final Producer producer = new Producer();
private static final Consumer consumer = new Consumer();
private static ExecutorService producerService;
private static ExecutorService consumerService;
...
producerService = Executors.newFixedThreadPool(PRODUCERS);
for (int i = 0; i < PRODUCERS; i++) {
    producerService.execute(producer);
}

consumerService = Executors.newFixedThreadPool(CONSUMERS);
for (int i = 0; i < CONSUMERS; i++) {
    consumerService.execute(consumer);
}
```

The queue in which the producers can add the checked bulbs can be of the `LinkedTransferQueue` or `ConcurrentLinkedQueue` type, and so on.

The complete source code based on `LinkedTransferQueue` and `ConcurrentLinkedQueue` can be found in the code bundled with this book.

204. Cached and scheduled thread pools

This problem reiterates the scenario from the *Thread pool with a single thread* section. This time, we assume that the producer (more than one producer can be used as well) checks a bulb in no more than one second. Moreover, a consumer (packer) needs a maximum of 10 seconds to pack a bulb. The producer and consumer times can be shaped as follows:

```
private static final int MAX_PROD_TIME_MS = 1 * 1000;
private static final int MAX_CONS_TIME_MS = 10 * 1000;
```

Obviously, in these conditions, one consumer cannot face the incoming flux. The queue used for storing bulbs until they are packed will continuously increase. The producer will add to this queue much faster than the consumer can poll. Therefore, more consumers are needed, as in the following diagram:

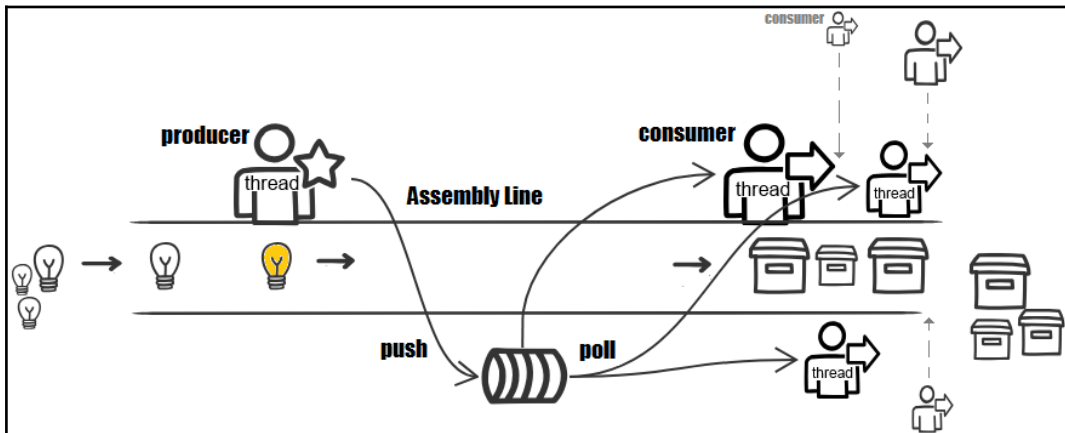

Since there is a single producer, we can rely on `Executors.newSingleThreadExecutor()`:

```
private static volatile boolean runningProducer;
private static ExecutorService producerService;
private static final Producer producer = new Producer();
...
public static void startAssemblyLine() {
    ...
    runningProducer = true;
    producerService = Executors.newSingleThreadExecutor();
    producerService.execute(producer);
    ...
}
```

The Producer is almost the same as in the previous problems except for the `extraProdTime` variable:

```
private static int extraProdTime;
private static final Random rnd = new Random();
...
private static class Producer implements Runnable {

    @Override
    public void run() {
        while (runningProducer) {
            try {
                String bulb = "bulb-" + rnd.nextInt(1000);
                Thread.sleep(rnd.nextInt(MAX_PROD_TIME_MS) + extraProdTime);
                queue.offer(bulb);

                logger.info(() -> "Checked: " + bulb);
            } catch (InterruptedException ex) {
                Thread.currentThread().interrupt();
                logger.severe(() -> "Exception: " + ex);
                break;
            }
        }
    }
}
```

The `extraProdTime` variable is initially 0. This will be needed when we slow down the producer:

```
Thread.sleep(rnd.nextInt(MAX_PROD_TIME_MS) + extraProdTime);
```

After running at a high speed for a while, the producer will get tired and will need more time to check each bulb. If the producer slows down the production rate, the number of consumers should be decreased too.

When the producer runs at a high speed, we will need more consumers (packers). But how many? Using a fixed number of consumers (`newFixedThreadPool()`) will raise at least two drawbacks:

- If the producer slows down at some moment, some consumers will remain without work and will simply stick around
- If the producer becomes even more efficient, more consumers are needed to face the incoming flux

Basically, we should be able to vary the number of consumers depending on producer efficiency.

For these kinds of jobs, we have `Executors.newCachedThreadPool()`. A cached thread pool will reuse the existing threads and will create new ones as needed (we can add more consumers). Threads are terminated and removed from the cache if they have not been used for 60 seconds (we can remove consumers).

Let's start with a single active consumer:

```
private static volatile boolean runningConsumer;
private static final AtomicInteger
    nrOfConsumers = new AtomicInteger();
private static final ThreadGroup threadGroup
    = new ThreadGroup("consumers");
private static final Consumer consumer = new Consumer();
private static ExecutorService consumerService;
...
public static void startAssemblyLine() {
    ...
    runningConsumer = true;
    consumerService = Executors
        .newCachedThreadPool((Runnable r) -> new Thread(threadGroup, r));
    nrOfConsumers.incrementAndGet();
    consumerService.execute(consumer);
    ...
}
```

Because we want to be able to see how many threads (consumers) are active at one moment, we add them in a `ThreadGroup` via a custom `ThreadFactory`:

```
consumerService = Executors
    .newCachedThreadPool((Runnable r) -> new Thread(threadGroup, r));
```

Later, we will be able to fetch the number of active consumers using the following code:

```
threadGroup.activeCount();
```

Knowing the number of active consumers is a good indicator that can be combined with the current size of the bulb queue for determining whether more consumers are needed.

The consumer implementation is listed as follows:

```
private static class Consumer implements Runnable {

    @Override
    public void run() {

        while (runningConsumer && queue.size() > 0
                || nrOfConsumers.get() == 1) {

            try {
                String bulb = queue.poll(MAX_PROD_TIME_MS
                    + extraProdTime, TimeUnit.MILLISECONDS);

                if (bulb != null) {
                    Thread.sleep(rnd.nextInt(MAX_CONS_TIME_MS));
                    logger.info(() -> "Packed: " + bulb + " by consumer: "
                        + Thread.currentThread().getName());
                }
            } catch (InterruptedException ex) {
                Thread.currentThread().interrupt();
                logger.severe(() -> "Exception: " + ex);
                break;
            }
        }

        nrOfConsumers.decrementAndGet();
        logger.warning(() -> "### Thread " +
            Thread.currentThread().getName()
                + " is going back to the pool in 60 seconds for now!");
    }
}
```

Assuming that the assembly line is running, a consumer will continue to pack bulbs as long as the queue is not empty or they are the only consumer left (we can't have 0 consumers). We can interpret that an empty queue means too many consumers are there. So, when a consumer sees that the queue is empty and they are not the only working consumer, they become idle (in 60 seconds, they will be automatically removed from the cached thread pool).

Do not confuse `nrOfConsumers` with `threadGroup.activeCount()`. The `nrOfConsumers` variable stores the number of consumers (threads) who pack bulbs right now, while `threadGroup.activeCount()` represents all active consumers (threads) including those that are not working right now (idle) and are just waiting to be reused or dispatched from the cache.

Now, in a real case, a supervisor will monitor the assembly line and when they notice that the current number of consumers cannot face the incoming influx, they will call more consumers to join (a maximum of 50 consumers are allowed). Moreover, when they notice that some consumers are just sticking around, they will dispatch them to other jobs. The following diagram is a graphical representation of this scenario:

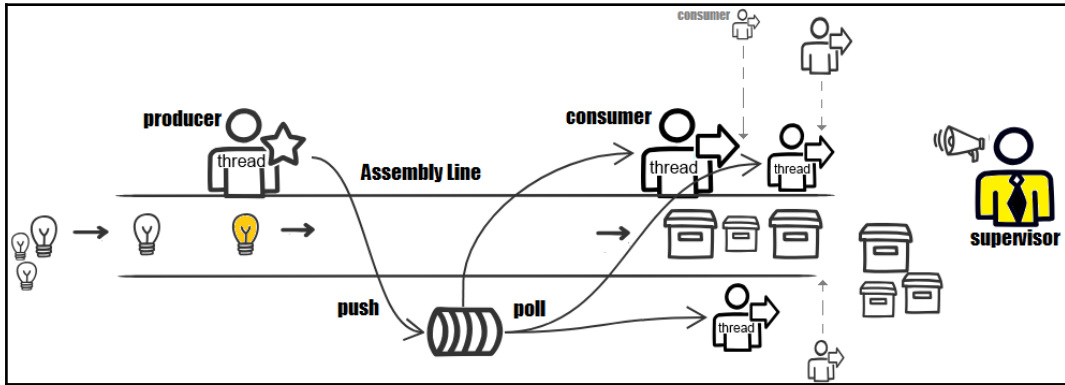

For testing purposes, our supervisor, `newSingleThreadScheduledExecutor()`, will be a single-threaded executor that can schedule the given commands to run after a specified delay. It may also execute the commands periodically:

```
private static final int MAX_NUMBER_OF_CONSUMERS = 50;
private static final int MAX_QUEUE_SIZE_ALLOWED = 5;
private static final int MONITOR_QUEUE_INITIAL_DELAY_MS = 5000;
private static final int MONITOR_QUEUE_RATE_MS = 3000;
private static ScheduledExecutorService monitorService;
...
private static void monitorQueueSize() {

    monitorService = Executors.newSingleThreadScheduledExecutor();

    monitorService.scheduleAtFixedRate(() -> {
        if (queue.size() > MAX_QUEUE_SIZE_ALLOWED
            && threadGroup.activeCount() < MAX_NUMBER_OF_CONSUMERS) {
            logger.warning("### Adding a new consumer (command) ...");

            nrOfConsumers.incrementAndGet();
            consumerService.execute(consumer);
        }

        logger.warning(() -> "### Bulbs in queue: " + queue.size()
            + " | Active threads: " + threadGroup.activeCount())
    }, 0, MONITOR_QUEUE_RATE_MS, MONITOR_QUEUE_RATE_MS);
}
```

```

    + " | Consumers: " + nrOfConsumers.get ()
    + " | Idle: " + (threadGroup.activeCount ()
      - nrOfConsumers.get ());
  }, MONITOR_QUEUE_INITIAL_DELAY_MS, MONITOR_QUEUE_RATE_MS,
    TimeUnit.MILLISECONDS);
}

```

We rely on `scheduleAtFixedRate()` to monitor the assembly line every three seconds with an initial delay of five seconds. So, in every three seconds, the supervisor checks the bulb queue size. If there are more than five bulbs in the queue and fewer than 50 consumers, the supervisor requests a new consumer to join the assembly line. If the queue contains five or fewer bulbs or there are already 50 consumers, the supervisor doesn't take any action.

If we start the assembly line now, we can see how the number of consumers increases until the queue size is fewer than six. A possible snapshot will be as follows:

```

Starting assembly line ...
[11:53:20] [INFO] Checked: bulb-488
...
[11:53:24] [WARNING] ### Adding a new consumer (command) ...
[11:53:24] [WARNING] ### Bulbs in queue: 7
                        | Active threads: 2
                        | Consumers: 2
                        | Idle: 0
[11:53:25] [INFO] Checked: bulb-738
...
[11:53:36] [WARNING] ### Bulbs in queue: 23
                        | Active threads: 6
                        | Consumers: 6
                        | Idle: 0
...

```

When there are more threads than needed, some of them become idle. If for 60 seconds they don't receive a job, they are removed from the cache. If a job occurs when there is no idle thread, a new thread will be created. This process is repeated constantly until we notice a balance in the assembly line. After a while, things start to calm down and the proper number of consumers will be in a small range (small fluctuations). This happens because the producer outputs at a random speed bounded up by a maximum of one second.

After a while (for example, after 20 seconds), let's slow down the producer by four seconds (so, a bulb can be checked in a maximum of five seconds now):

```
private static final int SLOW_DOWN_PRODUCER_MS = 20 * 1000;
private static final int EXTRA_TIME_MS = 4 * 1000;
```

This can be done using another `newSingleThreadScheduledExecutor()`, as follows:

```
private static void slowdownProducer() {

    slowdownerService = Executors.newSingleThreadScheduledExecutor();

    slowdownerService.schedule(() -> {
        logger.warning("### Slow down producer ...");
        extraProdTime = EXTRA_TIME_MS;
    }, SLOW_DOWN_PRODUCER_MS, TimeUnit.MILLISECONDS);
}
```

This will happen only once, 20 seconds after starting the assembly line. Since the producer speed was decreased by four seconds, there is no need to have the same number of consumers to maintain a queue maximum of five bulbs.

This is revealed in the output, as shown (notice that, at some moments, there is only one consumer needed to handle the queue):

```
...
[11:53:36] [WARNING] ### Bulbs in queue: 23
                | Active threads: 6
                | Consumers: 6
                | Idle: 0
...
[11:53:39] [WARNING] ### Slow down producer ...
...
[11:53:56] [WARNING] ### Thread Thread-5 is going
                back to the pool in 60 seconds for now!
[11:53:56] [INFO] Packed: bulb-346 by consumer: Thread-2
...
[11:54:36] [WARNING] ### Bulbs in queue: 1
                | Active threads: 12
                | Consumers: 1
                | Idle: 11
...
[11:55:48] [WARNING] ### Bulbs in queue: 3
                | Active threads: 1
                | Consumers: 1
                | Idle: 0
```

```
...  
Assembling line was successfully stopped!
```

Starting the supervisor takes place after starting the assembly line:

```
public static void startAssemblyLine() {  
    ...  
    monitorQueueSize();  
    slowdownProducer();  
}
```

The complete application is available in the code bundled with this book.



When using cached-thread pools, pay attention to the number of threads created to accommodate the number of submitted tasks. While for single-thread and fixed-thread pools, we control the number of created threads, a cached-pool can decide to create too many threads. Basically, creating threads uncontrollably may run out of resources quickly. So, in systems that are vulnerable to overload, it's better to rely on fixed-thread pools.

205. Work-stealing thread pool

Let's focus on the packing process, which should be implemented via a work-stealing thread pool. To start, let's discuss what a work-stealing thread pool is, and let's do it via a comparison with a classic thread pool. The following diagram depicts how a classic thread pool works:

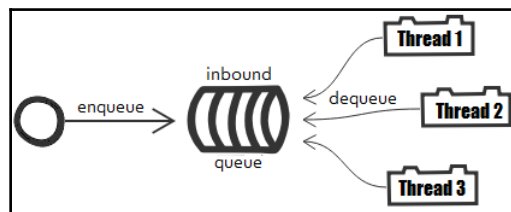

So, a thread pool relies on an internal inbound queue to store tasks. Each thread must dequeue a task and execute it. This is suitable for cases when the tasks are time-consuming and their number is relatively low. On the other hand, if these tasks are many and are small (they require a small amount of time to be executed), there will be a lot of contentions as well. This is not good, and even if this is a lock-free queue the problem is not entirely solved.

In order to reduce contentions and increase performance, a thread pool can rely on a work-stealing algorithm and a queue per thread. In this case, there is a central inbound queue for all tasks, and an extra queue (known as the local task queue) for each thread (worker thread), as in the following diagram:

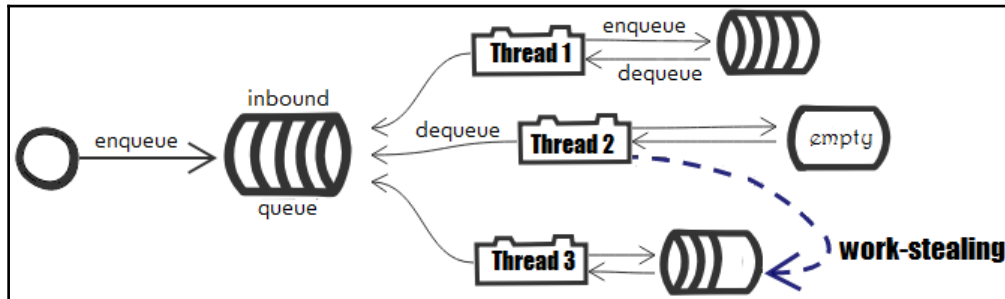

So, each thread will dequeue tasks from the central queue and enqueue them in their own queue. Each thread has its own local queue of tasks. Further, when a thread wants to process a task, it simply dequeues a task from its own local queue. As long as its local queue is not empty, the thread will continue to process the tasks from it without bothering other threads (no contentions with other threads). When its local queue is empty (as in the case of **Thread 2** in the preceding diagram), it tries to steal (via a working-stealing algorithm) tasks from local queues that belong to other threads (for example, **Thread 2** steals tasks from **Thread 3**). If it doesn't find anything to steal, it accesses the shared central inbound queue.

Each local queue is actually a **deque** (short for **double-ended queue**), therefore it can be accessed efficiently from both ends. The thread sees its deque as a stack, meaning that it will enqueue (add new tasks) and dequeue (take tasks for processing) from only one end. On the other hand, when a thread tries to steal from the queue of another thread, it will access the other end (for example, **Thread 2** steals from **Thread 3** queue from the other end). So, tasks are processed from one end and stolen from the other end.

If two threads try to steal from the same local queue then there is contention, but normally this should be insignificant.

What we've just described is the fork/join framework introduced in JDK 7 and exemplified in the *The fork/join framework* section. Starting with JDK 8, the `Executors` class was enriched with a work-stealing thread pool using the number of available processors as its target parallelism level. This is available via `Executors.newWorkStealingPool()` and `Executors.newWorkStealingPool(int parallelism)`.

Let's see the source code of this thread pool:

```
public static ExecutorService newWorkStealingPool() {  
  
    return new ForkJoinPool(Runtime.getRuntime().availableProcessors(),  
        ForkJoinPool.defaultForkJoinWorkerThreadFactory,  
        null, true);  
}
```

So, internally, this thread pool instantiates `ForkJoinPool` via the following constructor:

```
public ForkJoinPool(int parallelism,  
    ForkJoinPool.ForkJoinWorkerThreadFactory factory,  
    Thread.UncaughtExceptionHandler handler,  
    boolean asyncMode)
```

We have the `parallelism` level set to `availableProcessors()`, the default thread factory for returning new threads, `Thread.UncaughtExceptionHandler`, passed as `null`, and `asyncMode` set to `true`. Setting `asyncMode` to `true` means that it empowers the local **First In First Out (FIFO)** scheduling mode for tasks that are forked and never joined. This mode may be more suitable than the default one (locally stack-based) in programs that rely on worker threads to process only event-style asynchronous tasks.

Nevertheless, don't forget that the local task queue and work-stealing algorithm are empowered only if the worker threads schedule new tasks in their own local queues. Otherwise, `ForkJoinPool` is just a `ThreadPoolExecutor` with extra overhead.

When we work directly with `ForkJoinPool`, we can instruct tasks to explicitly schedule new tasks during execution using `ForkJoinTask` (typically, via `RecursiveTask` or `RecursiveAction`).

But since `newWorkStealingPool()` is a higher level of abstraction for `ForkJoinPool`, we cannot instruct tasks to explicitly schedule new tasks during execution. Therefore, `newWorkStealingPool()` will decide internally how to work based on the tasks that we pass. We can try a comparison between `newWorkStealingPool()`, `newCachedThreadPool()`, and `newFixedThreadPool()`, and see how they perform in two scenarios:

- For a large number of small tasks
- For a small number of time-consuming tasks

Let's take a look at the solutions for both these scenarios in the next sections.

A large number of small tasks

Since the producers (checkers) and consumer (packers) don't work at the same time, we can easily fill up a queue with 15,000,000 bulbs via a trivial `for` loop (we are not very interested in this part of the assembly line). This is shown in the following code snippet:

```
private static final Random rnd = new Random();
private static final int MAX_PROD_BULBS = 15_000_000;
private static final BlockingQueue<String> queue
    = new LinkedBlockingQueue<>();
...
private static void simulatingProducers() {
    logger.info("Simulating the job of the producers overnight ...");
    logger.info(() -> "The producers checked "
        + MAX_PROD_BULBS + " bulbs ...");

    for (int i = 0; i < MAX_PROD_BULBS; i++) {
        queue.offer("bulb-" + rnd.nextInt(1000));
    }
}
```

Further, let's create a default work-stealing thread pool:

```
private static ExecutorService consumerService
    = Executors.newWorkStealingPool();
```

For comparison, we will also use the following thread pools:

- A cached thread pool:

```
private static ExecutorService consumerService
    = Executors.newCachedThreadPool();
```

- A fixed thread pool using the number of available processors as the number of threads (the number of processors is used by the default work-stealing thread pool as the parallelism level):

```
private static final Consumer consumer = new Consumer();
private static final int PROCESSORS
    = Runtime.getRuntime().availableProcessors();
private static ExecutorService consumerService
    = Executors.newFixedThreadPool(PROCESSORS);
```

And, let's start 15,000,000 small tasks:

```
for (int i = 0; i < queueSize; i++) {
    consumerService.execute(consumer);
}
```

The Consumer wraps a simple `queue.poll()` operation, therefore it should run pretty fast, as shown in the following snippet:

```
private static class Consumer implements Runnable {

    @Override
    public void run() {
        String bulb = queue.poll();

        if (bulb != null) {
            // nothing
        }
    }
}
```

The following graph represents the collected data for 10 runs:

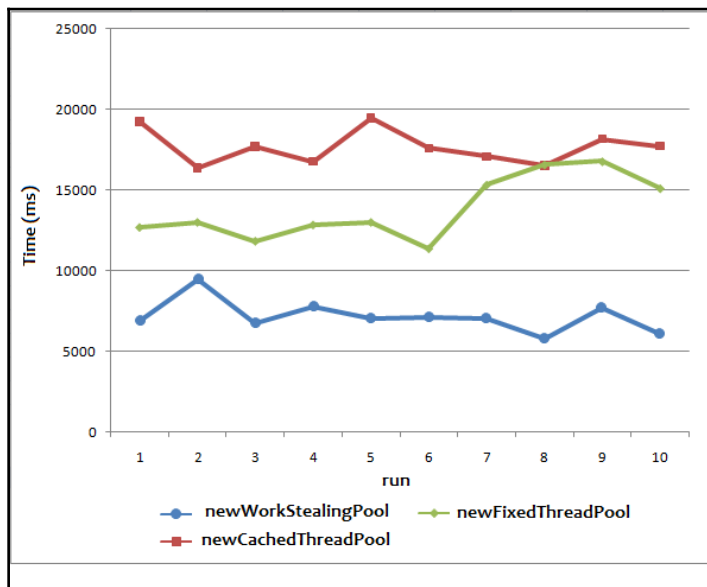

Even if this is not a professional benchmark, we can see that the work-stealing thread pool has obtained the best results, while the cached thread pool has the worse results.

A small number of time-consuming tasks

Instead of filling a queue with 15,000,000 bulbs, let's fill 15 queues with 1,000,000 bulbs each:

```
private static final int MAX_PROD_BULBS = 15_000_000;
private static final int CHUNK_BULBS = 1_000_000;
private static final Random rnd = new Random();
private static final Queue<BlockingQueue<String>> chunks
    = new LinkedBlockingQueue<>();
...
private static Queue<BlockingQueue<String>> simulatingProducers() {
    logger.info("Simulating the job of the producers overnight ...");
    logger.info(() -> "The producers checked "
        + MAX_PROD_BULBS + " bulbs ...");

    int counter = 0;
    while (counter < MAX_PROD_BULBS) {
        BlockingQueue chunk = new LinkedBlockingQueue<>(CHUNK_BULBS);

        for (int i = 0; i < CHUNK_BULBS; i++) {
            chunk.offer("bulb-" + rnd.nextInt(1000));
        }

        chunks.offer(chunk);
        counter += CHUNK_BULBS;
    }

    return chunks;
}
```

And, let's fire up 15 tasks using the following code:

```
while (!chunks.isEmpty()) {
    Consumer consumer = new Consumer(chunks.poll());
    consumerService.execute(consumer);
}
```

Each Consumer loops 1,000,000 bulbs using this code:

```
private static class Consumer implements Runnable {

    private final BlockingQueue<String> bulbs;

    public Consumer(BlockingQueue<String> bulbs) {
        this.bulbs = bulbs;
    }
}
```

```

@Override
public void run() {
    while (!bulbs.isEmpty()) {
        String bulb = bulbs.poll();

        if (bulb != null) {}
    }
}
}

```

The following graph represents the collected data for 10 runs:

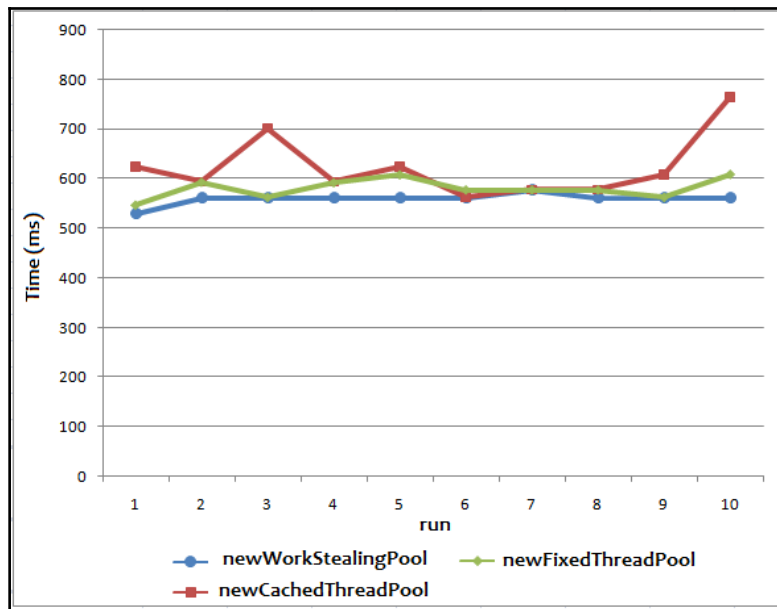

This time, it looks like the work-stealing thread pool worked as a regular thread pool.

206. Callable and Future

This problem reiterates the scenario from the *Thread pool with a single thread* section. We want a single producer and consumer that follow this scenario:

1. An automatic system sends a request to the producer, saying, *check this bulb and if it is ok then return it to me, otherwise tell me what went wrong with this bulb.*
2. The automatic system waits for the producer to check the bulb.

3. When the automatic system receives the checked bulb, it is then passed further to the consumer (packer) and repeats the process.
4. If a bulb has a defect, the producer throws an exception (`DefectBulbException`) and the automatic system will inspect the cause of the problem.

This scenario is depicted in the following diagram:

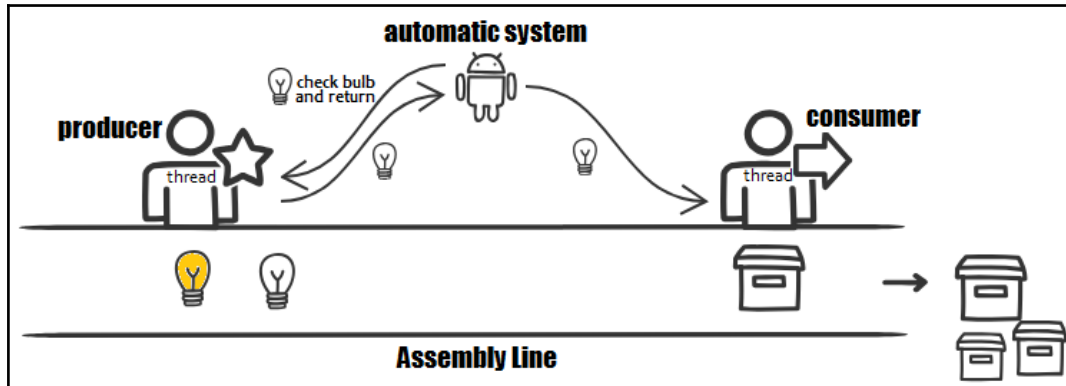

In order to shape this scenario, the producer should be able to return a result and throw an exception. Since our producer is a `Runnable`, it can't do either of these. But Java defines an interface that is named `Callable`. This is a functional interface with a method named `call()`. In contrast to the `run()` method of `Runnable`, the `call()` method can return a result and even throw an exception, `V call() throws Exception`.

This means that the producer (checker) can be written as follows:

```
private static volatile boolean runningProducer;
private static final int MAX_PROD_TIME_MS = 5 * 1000;
private static final Random rnd = new Random();
...
private static class Producer implements Callable {

    private final String bulb;

    private Producer(String bulb) {
        this.bulb = bulb;
    }

    @Override
    public String call()
```

```
        throws DefectBulbException, InterruptedException {

    if (runningProducer) {
        Thread.sleep(rnd.nextInt(MAX_PROD_TIME_MS));

        if (rnd.nextInt(100) < 5) {
            throw new DefectBulbException("Defect: " + bulb);
        } else {
            logger.info(() -> "Checked: " + bulb);
        }

        return bulb;
    }

    return "";
}
}
```

The executor service can submit a task to a `Callable` via the `submit()` method, but it doesn't know when the result of the submitted task will be available.

Therefore, `Callable` immediately returns a special type named, `Future`. The result of an asynchronous computation is represented by a `Future`—via `Future` we can fetch the result of the task when it is available. Conceptually speaking, we can think of a `Future` as a JavaScript promise, or as a result of a computation that will be done at a later point in time. Now, let's create a `Producer` and submit it to a `Callable`:

```
String bulb = "bulb-" + rnd.nextInt(1000);
Producer producer = new Producer(bulb);

Future<String> bulbFuture = producerService.submit(producer);
// this line executes immediately
```

Since the `Callable` immediately returns a `Future`, we can perform other tasks while waiting for the result of the submitted task (the `isDone()` flag method returns `true` if this task is completed):

```
while (!future.isDone()) {
    System.out.println("Do something else ...");
}
```

Retrieving the result of `Future` can be done using the blocking method, `Future.get()`. This method blocks until the result is available or the specified timeout elapsed (if the result is not available before the timeout, a `TimeoutException` is thrown):

```
String checkedBulb = bulbFuture.get(
    MAX_PROD_TIME_MS + 1000, TimeUnit.MILLISECONDS);

// this line executes only after the result is available
```

Once the result is available, we can pass it to `Consumer` and submit another task to `Producer`. This cycle repeats as long as the consumer and the producer are running. The code for this is as follows:

```
private static void automaticSystem() {

    while (runningProducer && runningConsumer) {
        String bulb = "bulb-" + rnd.nextInt(1000);

        Producer producer = new Producer(bulb);
        Future<String> bulbFuture = producerService.submit(producer);
        ...
        String checkedBulb = bulbFuture.get(
            MAX_PROD_TIME_MS + 1000, TimeUnit.MILLISECONDS);

        Consumer consumer = new Consumer(checkedBulb);
        if (runningConsumer) {
            consumerService.execute(consumer);
        }
    }
    ...
}
```

The `Consumer` is still a `Runnable`, therefore it cannot return a result or throw an exception:

```
private static final int MAX_CONS_TIME_MS = 3 * 1000;
...
private static class Consumer implements Runnable {

    private final String bulb;

    private Consumer(String bulb) {
        this.bulb = bulb;
    }

    @Override
```

```
public void run() {
    if (runningConsumer) {
        try {
            Thread.sleep(rnd.nextInt(MAX_CONS_TIME_MS));
            logger.info(() -> "Packed: " + bulb);
        } catch (InterruptedException ex) {
            Thread.currentThread().interrupt();
            logger.severe(() -> "Exception: " + ex);
        }
    }
}
```

Finally, we need to start the automatic system. The code for this is as follows:

```
public static void startAssemblyLine() {
    ...
    runningProducer = true;
    consumerService = Executors.newSingleThreadExecutor();

    runningConsumer = true;
    producerService = Executors.newSingleThreadExecutor();

    new Thread(() -> {
        automaticSystem();
    }).start();
}
```

Notice that we don't want to block the main thread, therefore we start the automatic system in a new thread. This way the main thread can control the start-stop process of the assembly line.

Let's run the assembly line for several minutes to collect some output:

```
Starting assembly line ...
[08:38:41] [INFO ] Checked: bulb-879
...
[08:38:52] [SEVERE ] Exception: DefectBulbException: Defect: bulb-553
[08:38:53] [INFO ] Packed: bulb-305
...
```

OK, the job is done! Let's tackle the final topic here.

Canceling a Future

A `Future` can be canceled. This is accomplished using the `cancel(boolean mayInterruptIfRunning)` method. If we pass it as `true`, the thread that executes the task is interrupted, otherwise, the thread may complete the task. This method returns `true` if the task was successfully canceled, otherwise it returns `false` (typically, because it has already completed normally). Here is a simple example that cancels a task if it takes more than one second to run:

```
long startTime = System.currentTimeMillis();

Future<String> future = executorService.submit(() -> {
    Thread.sleep(3000);

    return "Task completed";
});

while (!future.isDone()) {
    System.out.println("Task is in progress ...");
    Thread.sleep(100);

    long elapsedTime = (System.currentTimeMillis() - startTime);

    if (elapsedTime > 1000) {
        future.cancel(true);
    }
}
```

The `isCancelled()` method will return `true` if the task was canceled before it completes normally:

```
System.out.println("Task was cancelled: " + future.isCancelled()
    + "\nTask is done: " + future.isDone());
```

The output will be as follows:

```
Task is in progress ...
Task is in progress ...
...
Task was cancelled: true
Task is done: true
```

Here are some bonus examples:

- Using Callable and lambdas:

```
Future<String> future = executorService.submit(() -> {
    return "Hello to you!";
});
```

- Getting a Callable that returns null via Executors.callable (Runnable task):

```
Callable<Object> callable = Executors.callable(() -> {
    System.out.println("Hello to you!");
});

Future<Object> future = executorService.submit(callable);
```

- Getting a Callable that returns a result (T) via Executors.callable (Runnable task, T result):

```
Callable<String> callable = Executors.callable(() -> {
    System.out.println("Hello to you!");
}, "Hi");

Future<String> future = executorService.submit(callable);
```

207. Invoking multiple Callable tasks

Since the producers (checkers) don't work at the same time with the consumers (packers), we can just simulate their work via a `for` that adds 100 checked bulbs in a queue:

```
private static final BlockingQueue<String> queue
    = new LinkedBlockingQueue<>();
...
private static void simulatingProducers() {

    for (int i = 0; i < MAX_PROD_BULBS; i++) {
        queue.offer("bulb-" + rnd.nextInt(1000));
    }
}
```

Now, the consumers must pack each bulb and return it. This means that the Consumer is a Callable:

```
private static class Consumer implements Callable {

    @Override
    public String call() throws InterruptedException {
        String bulb = queue.poll();

        Thread.sleep(100);

        if (bulb != null) {
            logger.info(() -> "Packed: " + bulb + " by consumer: "
                + Thread.currentThread().getName());

            return bulb;
        }

        return "";
    }
}
```

But remember that we should submit all Callable tasks and wait for all of them to complete. This can be achieved via the `ExecutorService.invokeAll()` method. This method takes a collection of tasks (`Collection<? extends Callable<T>>`) and returns a list of instances of `Future` (`List<Future<T>>`) as an argument. Any call to `Future.get()` will be blocked until all the instances of `Future` are complete.

So, first we create a list of 100 tasks:

```
private static final Consumer consumer = new Consumer();
...
List<Callable<String>> tasks = new ArrayList<>();
for (int i = 0; i < queue.size(); i++) {
    tasks.add(consumer);
}
```

Further, we execute all these tasks and get the list of `Future`:

```
private static ExecutorService consumerService
    = Executors.newWorkStealingPool();
...
List<Future<String>> futures = consumerService.invokeAll(tasks);
```

Finally, we process (in this case, display) the results:

```
for (Future<String> future: futures) {
    String bulb = future.get();
    logger.info(() -> "Future done: " + bulb);
}
```

Notice that the first call to the `future.get()` statement blocks until all the instances of `Future` are complete. This will lead to the following output:

```
[12:06:41] [INFO] Packed: bulb-595 by consumer: ForkJoinPool-1-
worker-9
...
[12:06:42] [INFO] Packed: bulb-478 by consumer: ForkJoinPool-1-
worker-15
[12:06:43] [INFO] Future done: bulb-595
...
```

Sometimes, we want to submit several tasks and wait for any one of them to complete. This can be achieved via `ExecutorService.invokeAny()`. Exactly like `invokeAll()`, this method gets as an argument a collection of tasks (`Collection<? extends Callable<T>>`). But it returns the result of the fastest task (not a `Future`) and cancels all other tasks that have not completed yet, for example:

```
String bulb = consumerService.invokeAny(tasks);
```

If you don't want to wait for all `Future` to finish, proceed as follows:

```
int queueSize = queue.size();
List<Future<String>> futures = new ArrayList<>();
for (int i = 0; i < queueSize; i++) {
    futures.add(consumerService.submit(consumer));
}

for (Future<String> future: futures) {
    String bulb = future.get();
    logger.info(() -> "Future done: " + bulb);
}
```

This will not block until all tasks are done. Take a look at the following output sample:

```
[12:08:56] [INFO ] Packed: bulb-894 by consumer: ForkJoinPool-1-
worker-7
[12:08:56] [INFO ] Future done: bulb-894
[12:08:56] [INFO ] Packed: bulb-953 by consumer: ForkJoinPool-1-
```



```
worker-5
...
```

208. Latches

A *latch* is a Java synchronizer that allows one or more threads to wait until a bunch of events in other threads has completed. It starts from a given counter (commonly representing the number of events that should be waited), and each event that completes is responsible for decrementing the counter. When the counter reaches zero all the waiting threads can pass through. This is the terminal state of a latch. A latch cannot be reset or reused, so the waited events can happen only once. The following diagram shows, in four steps, how a latch with three threads works:

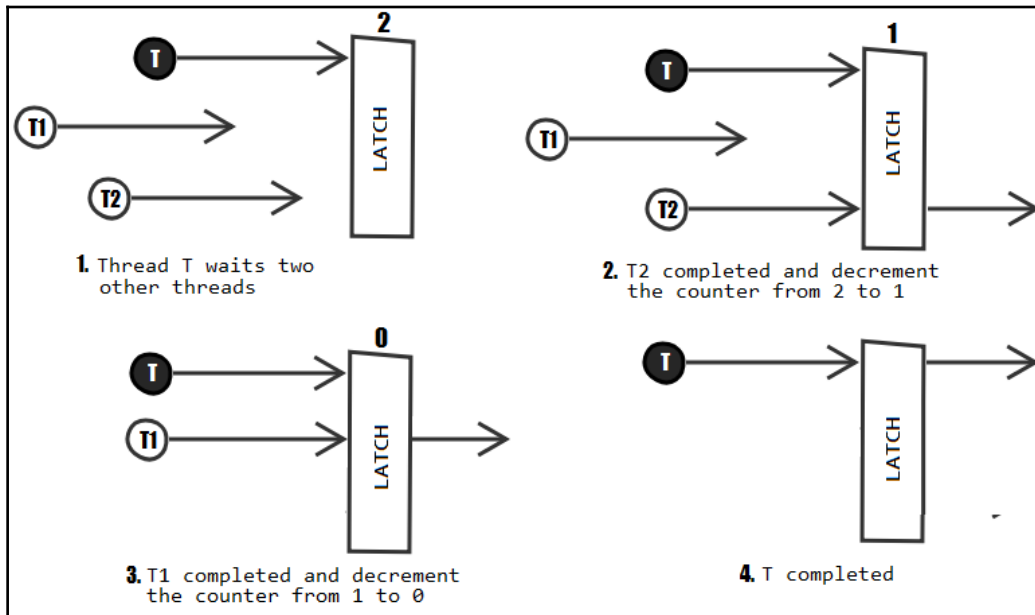

In API terms, a latch is implemented using `java.util.concurrent.CountDownLatch`.

The initial counter is set in the `CountDownLatch` constructor as an integer. For example, a `CountDownLatch` with a counter equal to 3 can be defined as follows:

```
CountDownLatch latch = new CountDownLatch(3);
```

All threads that call the `await()` method will be blocked until the counter reaches zero. So, a thread that wants to be blocked until the latch reaches the terminal state will call `await()`. Each event that completes can call the `countDown()` method. This method decrements the counter with one value. Until the counter becomes zero, the threads that called `await()` are still blocked.

A latch can be used for a wide range of problems. For now, let's focus on our problem that should simulate the process of starting a server. The server is considered started after its internal services have started. Services can be started concurrently and are independent of each other. Starting a server is a process that takes a while and requires us to start all the underlying services of that server. Therefore, the thread that finalizes and validates the server start should wait until all server services (events) have started in other threads. If we assume that we have three services, we can write a `ServerService` class as follows:

```
public class ServerInstance implements Runnable {

    private static final Logger logger =
        Logger.getLogger(ServerInstance.class.getName());

    private final CountdownLatch latch = new CountdownLatch(3);

    @Override
    public void run() {
        logger.info("The server is getting ready to start ");
        logger.info("Starting services ...\n");

        long starting = System.currentTimeMillis();

        Thread service1 = new Thread(
            new ServerService(latch, "HTTP Listeners"));
        Thread service2 = new Thread(
            new ServerService(latch, "JMX"));
        Thread service3 = new Thread(
            new ServerService(latch, "Connectors"));

        service1.start();
        service2.start();
        service3.start();

        try {
            latch.await();
            logger.info(() -> "Server has successfully started in "
                + (System.currentTimeMillis() - starting) / 1000
                + " seconds");
        } catch (InterruptedException ex) {
```

```
        Thread.currentThread().interrupt();
        // log ex
    }
}
}
```

First, we define a `CountDownLatch` with a counter of three. Second, we start the services in three different threads. Finally, we block this thread via `await()`. Now, the following class simulates the starting process of services via random sleep:

```
public class ServerService implements Runnable {

    private static final Logger logger =
        Logger.getLogger(ServerService.class.getName());

    private final String serviceName;
    private final CountDownLatch latch;
    private final Random rnd = new Random();

    public ServerService(CountDownLatch latch, String serviceName) {
        this.latch = latch;
        this.serviceName = serviceName;
    }

    @Override
    public void run() {

        int startingIn = rnd.nextInt(10) * 1000;

        try {
            logger.info(() -> "Starting service '" + serviceName + "' ...");

            Thread.sleep(startingIn);

            logger.info(() -> "Service '" + serviceName
                + "' has successfully started in "
                + startingIn / 1000 + " seconds");

        } catch (InterruptedException ex) {
            Thread.currentThread().interrupt();
            // log ex
        } finally {
            latch.countDown();

            logger.info(() -> "Service '" + serviceName + "' running ...");
        }
    }
}
```

Each service that started successfully (or failed) will decrement the latch via `countDown()`. Once the counter reaches zero, the server is considered started. Let's call it:

```
Thread server = new Thread(new ServerInstance());
server.start();
```

Here is a possible output:

```
[08:49:17] [INFO] The server is getting ready to start

[08:49:17] [INFO] Starting services ...
[08:49:17] [INFO] Starting service 'JMX' ...
[08:49:17] [INFO] Starting service 'Connectors' ...
[08:49:17] [INFO] Starting service 'HTTP Listeners' ...

[08:49:22] [INFO] Service 'HTTP Listeners' started in 5 seconds
[08:49:22] [INFO] Service 'HTTP Listeners' running ...
[08:49:25] [INFO] Service 'JMX' started in 8 seconds
[08:49:25] [INFO] Service 'JMX' running ...
[08:49:26] [INFO] Service 'Connectors' started in 9 seconds
[08:49:26] [INFO] Service 'Connectors' running ...

[08:49:26] [INFO] Server has successfully started in 9 seconds
```



In order to avoid indefinite waiting, the `CountDownLatch` class has an `await()` flavor that accepts a timeout, `await(long timeout, TimeUnit unit)`. If the waiting time elapses before the count reaches zero, this method returns `false`.

209. Barrier

A *barrier* is a Java synchronizer that allows a group of threads (known as *parties*) to reach a common barrier point. Basically, a group of threads waits for each other to meet at the barrier. It is like a bunch of friends who decide on a meeting point, and when all of them get this point, they go farther together. They won't leave the meeting point until all of them have arrived or until they feel they've been waiting too long.

This synchronizer works well for problems that rely on a task that can be divided into subtasks. Each subtask runs in a different thread and waits for the rest of the threads. When all the threads complete, they combine their results in a single result.

This following diagram shows an example of a barrier flow with three threads:

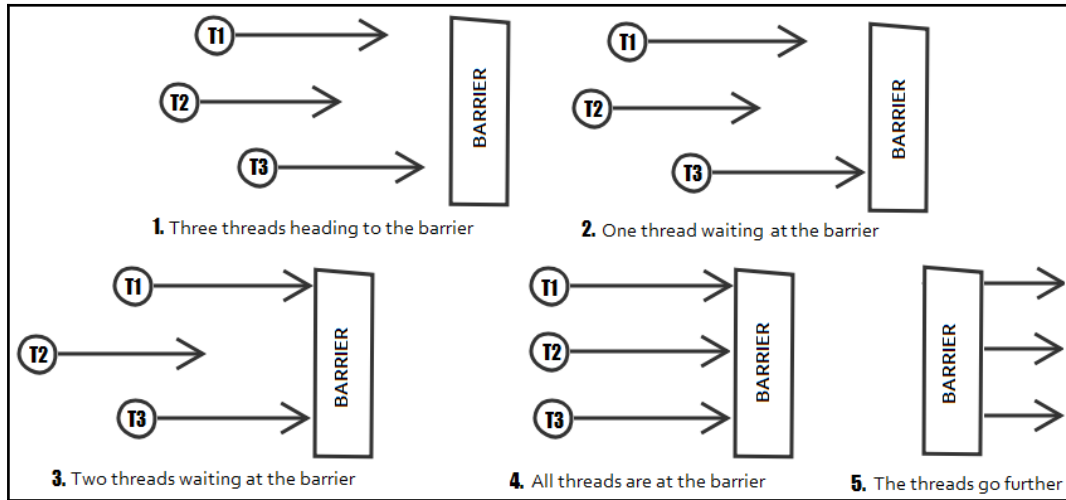

In API terms, a barrier is implemented using `java.util.concurrent.CyclicBarrier`.

A `CyclicBarrier` can be constructed via two constructors:

- One of them allows us to specify the number of parties (this is an integer)
- The other one allows us to add an action that should take place after all parties are at the barrier (this is a `Runnable`)

This action takes place when all threads in the party arrive, but before the release of any threads.

When a thread is ready to wait at the barrier, it simply calls the `await()` method. This method can wait indefinitely or until the specified timeout (if the specified timeout elapses or the thread is interrupted, this thread is released with a `TimeoutException`; the barrier is considered *broken*, and all the waiting threads at the barrier are released with a `BrokenBarrierException`). We can find out how many parties are required to trip this barrier via the `getParties()` method and how many are currently waiting at the barrier via the `getNumberWaiting()` method.



The `await()` method returns an integer that represents the arrival index of the current thread, where the index `getParties() - 1` or `0` indicates the first or the last to arrive, respectively.

Let's assume that we want to start a server. The server is considered started after its internal services have started. Services can be prepared for start concurrently (this is time-consuming), but they run interdependently, therefore, once they are ready to start, they must be started all at once.

So, each service can be prepared to start in a separate thread. Once it is ready to start, the thread will wait at the barrier for the rest of the services. When all of them are ready to start, they cross the barrier and start running. Let's consider three services, so `CyclicBarrier` can be defined as follows:

```
Runnable barrierAction
    = () -> logger.info("Services are ready to start ...");

CyclicBarrier barrier = new CyclicBarrier(3, barrierAction);
```

And, let's prepare the services via three threads:

```
public class ServerInstance implements Runnable {

    private static final Logger logger
        = Logger.getLogger(ServerInstance.class.getName());

    private final Runnable barrierAction
        = () -> logger.info("Services are ready to start ...");

    private final CyclicBarrier barrier
        = new CyclicBarrier(3, barrierAction);

    @Override
    public void run() {
        logger.info("The server is getting ready to start ");
        logger.info("Starting services ...\\n");

        long starting = System.currentTimeMillis();

        Thread service1 = new Thread(
            new ServerService(barrier, "HTTP Listeners"));
        Thread service2 = new Thread(
            new ServerService(barrier, "JMX"));
        Thread service3 = new Thread(
            new ServerService(barrier, "Connectors"));

        service1.start();
        service2.start();
        service3.start();

        try {
```

```

        service1.join();
        service2.join();
        service3.join();

        logger.info(() -> "Server has successfully started in "
            + (System.currentTimeMillis() - starting) / 1000
            + " seconds");
    } catch (InterruptedException ex) {
        Thread.currentThread().interrupt();
        logger.severe(() -> "Exception: " + ex);
    }
}
}
}

```

The `ServerService` is responsible for preparing each service to start and blocking it at the barrier via `await()`:

```

public class ServerService implements Runnable {

    private static final Logger logger =
        Logger.getLogger(ServerService.class.getName());

    private final String serviceName;
    private final CyclicBarrier barrier;
    private final Random rnd = new Random();

    public ServerService(CyclicBarrier barrier, String serviceName) {
        this.barrier = barrier;
        this.serviceName = serviceName;
    }

    @Override
    public void run() {

        int startingIn = rnd.nextInt(10) * 1000;

        try {
            logger.info(() -> "Preparing service '"
                + serviceName + "' ...");

            Thread.sleep(startingIn);
            logger.info(() -> "Service '" + serviceName
                + "' was prepared in " + startingIn / 1000
                + " seconds (waiting for remaining services)");

            barrier.await();

            logger.info(() -> "The service '" + serviceName

```

```
        + " is running ...");
    } catch (InterruptedException ex) {
        Thread.currentThread().interrupt();
        logger.severe(() -> "Exception: " + ex);
    } catch (BrokenBarrierException ex) {
        logger.severe(() -> "Exception ... barrier is broken! " + ex);
    }
}
}
```

Now, let's run it:

```
Thread server = new Thread(new ServerInstance());
server.start();
```

Here is a possible output (notice how the threads have been released to cross the barrier):

```
[10:38:34] [INFO] The server is getting ready to start

[10:38:34] [INFO] Starting services ...
[10:38:34] [INFO] Preparing service 'Connectors' ...
[10:38:34] [INFO] Preparing service 'JMX' ...
[10:38:34] [INFO] Preparing service 'HTTP Listeners' ...

[10:38:35] [INFO] Service 'HTTP Listeners' was prepared in 1 seconds
                (waiting for remaining services)
[10:38:36] [INFO] Service 'JMX' was prepared in 2 seconds
                (waiting for remaining services)
[10:38:38] [INFO] Service 'Connectors' was prepared in 4 seconds
                (waiting for remaining services)

[10:38:38] [INFO] Services are ready to start ...

[10:38:38] [INFO] The service 'Connectors' is running ...
[10:38:38] [INFO] The service 'HTTP Listeners' is running ...
[10:38:38] [INFO] The service 'JMX' is running ...

[10:38:38] [INFO] Server has successfully started in 4 seconds
```



A `CyclicBarrier` is cyclic because it can be reset and reused. For this, call the `reset()` method after all threads waiting at the barrier are released, otherwise `BrokenBarrierException` will be thrown.

A barrier that is in a *broken* state will cause the `isBroken()` flag method to return `true`.

210. Exchanger

An *exchanger* is a Java synchronizer that allows two threads to exchange objects at an exchange or synchronization point.

Mainly, this kind of synchronizer acts as a barrier. Two threads wait for each other at a barrier. They exchange an object and continue their usual tasks when both arrive.

The following diagram depicts in four steps the flow of an exchanger:

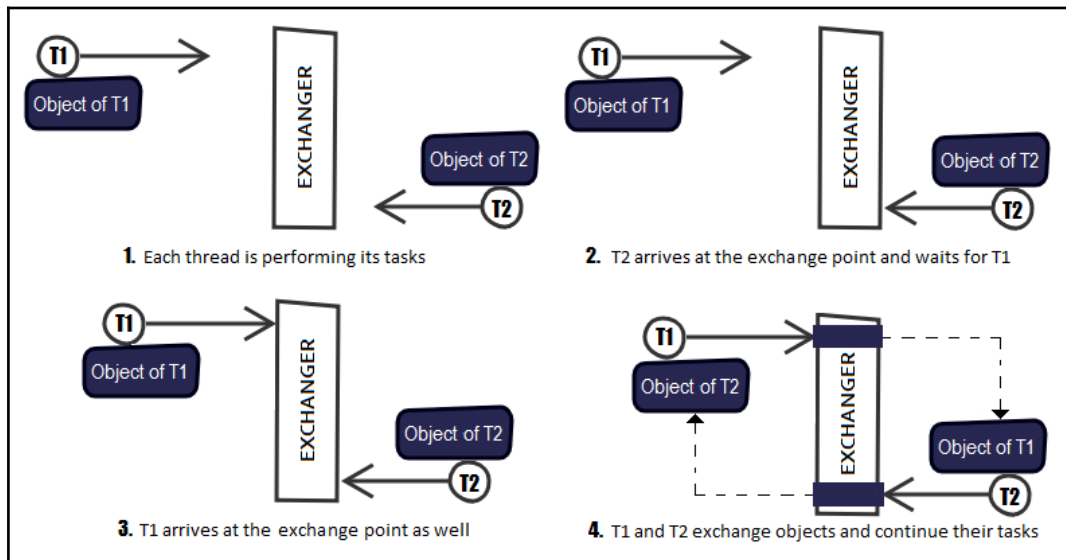

In API terms, this synchronizer is exposed by `java.util.concurrent.Exchanger`.

An `Exchanger` can be created via an empty constructor and exposes two `exchange()` methods:

- One that gets only the object that it will offer
- One that gets a timeout (before another thread enters the exchange, if the specified waiting time elapses, a `TimeoutException` will be thrown).

Remember our assembly line for bulbs? Well, let's assume that the producer (checker) adds the checked bulbs into a basket (for example, `List<String>`). When the basket is full, the producer exchanges it with the consumer (the packer) for an empty basket (for example, another `List<String>`). The process repeats as long as the assembly line is running.

The following diagram represents this flow:

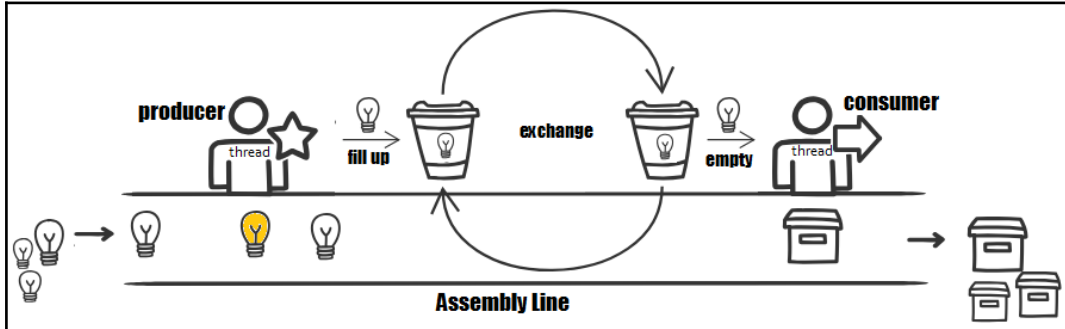

So, first we need the Exchanger:

```
private static final int BASKET_CAPACITY = 5;
...
private static final Exchanger<List<String>> exchanger
    = new Exchanger<>();
```

The producer fills up the basket and waits at the exchanging point for the consumer:

```
private static final int MAX_PROD_TIME_MS = 2 * 1000;
private static final Random rnd = new Random();
private static volatile boolean runningProducer;
...
private static class Producer implements Runnable {

    private List<String> basket = new ArrayList<>(BASKET_CAPACITY);

    @Override
    public void run() {

        while (runningProducer) {
            try {
                for (int i = 0; i < BASKET_CAPACITY; i++) {

                    String bulb = "bulb-" + rnd.nextInt(1000);
                    Thread.sleep(rnd.nextInt(MAX_PROD_TIME_MS));
```



```
        }

        basket.clear();
    } catch (InterruptedException ex) {
        Thread.currentThread().interrupt();
        logger.severe() -> "Exception: " + ex);
        break;
    }
}
}
```

The rest of the code was omitted for brevity.

Now, let's see a possible output:

```
Starting assembly line ...
[13:23:13] [INFO] Consumer: Waiting to exchange baskets ...
[13:23:15] [INFO] Checked and added in the basket: bulb-606
...
[13:23:18] [INFO] Producer: Waiting to exchange baskets ...
[13:23:18] [INFO] Consumer: Received the following bulbs:
[bulb-606, bulb-251, bulb-102, bulb-454, bulb-280]
[13:23:19] [INFO] Checked and added in the basket: bulb-16
...
[13:23:21] [INFO] Packed from basket: bulb-606
...
```

211. Semaphores

A *semaphore* is a Java synchronizer that allows us to control the number of threads that can access a resource at any one time. Conceptually, this synchronizer manages a bunch of *permits* (for example, similar to tokens). A thread that needs access to the resource must acquire a permit from the synchronizer. After the thread finishes its job with the resource, it must release the permit by returning it to the semaphore so that another thread can acquire it. A thread can acquire a permit immediately (if a permit is free), can wait for a certain amount of time, or can wait until a permit becomes free. Moreover, a thread can acquire and release more than one permit at a time, and a thread can release a permit even if it did not acquire one. This will add a permit to the semaphore; therefore a semaphore can start with one number of permits and die with another.

In API terms, this synchronizer is represented by `java.util.concurrent.Semaphore`.

Creating a `Semaphore` is as easy as calling one of its two constructors:

- `public Semaphore(int permits)`
- `public Semaphore(int permits, boolean fair)`

A fair `Semaphore` guarantees FIFO granting of permits under contention.

Acquiring a permit can be accomplished using the `acquire()` method. The process can be represented by the following bullets:

- Without arguments, this method will acquire a permit from this semaphore, blocking until one is available, or the thread is interrupted
- To acquire more than one permit, use `acquire(int permits)`
- To try to acquire a permit and return a flag value immediately, use `tryAcquire()` or `tryAcquire(int permits)`
- To acquire a permit by waiting for one to become available within the given waiting time (and the current thread has not been interrupted), use `tryAcquire(int permits, long timeout, TimeUnit unit)`
- To acquire a permit from this semaphore, blocking until one is available can be obtained via `acquireUninterruptibly()` and `acquireUninterruptibly(int permits)`
- To release a permit, use `release()`

Now, in our scenario, a barbershop has three seats and serves the customers in a FIFO manner. A customer tries for five seconds to take a seat. In the end, it releases the acquired seat. Check out the following code to see how a seat can be acquired and released:

```
public class Barbershop {

    private static final Logger logger =
        Logger.getLogger(Barbershop.class.getName());

    private final Semaphore seats;

    public Barbershop(int seatsCount) {
        this.seats = new Semaphore(seatsCount, true);
    }

    public boolean acquireSeat(int customerId) {
```

```
logger.info(() -> "Customer #" + customerId
    + " is trying to get a seat");

try {
    boolean acquired = seats.tryAcquire(
        5 * 1000, TimeUnit.MILLISECONDS);

    if (!acquired) {
        logger.info(() -> "Customer #" + customerId
            + " has left the barbershop");

        return false;
    }

    logger.info(() -> "Customer #" + customerId + " got a seat");

    return true;
} catch (InterruptedException ex) {
    Thread.currentThread().interrupt();
    logger.severe(() -> "Exception: " + ex);
}

return false;
}

public void releaseSeat(int customerId) {
    logger.info(() -> "Customer #" + customerId
        + " has released a seat");
    seats.release();
}
}
```

If no seat has been freed in these five seconds, the person leaves the barber shop. On the other hand, a customer that succeeds in taking a seat is served by a barber (this will take a random number of seconds between 0 and 10). Finally, the customer releases the seat. In code lines, this can be written as follows:

```
public class BarbershopCustomer implements Runnable {

    private static final Logger logger =
        Logger.getLogger(BarbershopCustomer.class.getName());
    private static final Random rnd = new Random();

    private final Barbershop barbershop;
    private final int customerId;

    public BarbershopCustomer(Barbershop barbershop, int customerId) {
        this.barbershop = barbershop;
    }
}
```

```
        this.customerId = customerId;
    }

    @Override
    public void run() {

        boolean acquired = barbershop.acquireSeat(customerId);

        if (acquired) {
            try {
                Thread.sleep(rnd.nextInt(10 * 1000));
            } catch (InterruptedException ex) {
                Thread.currentThread().interrupt();
                logger.severe(() -> "Exception: " + ex);
            } finally {
                barbershop.releaseSeat(customerId);
            }
        } else {
            Thread.currentThread().interrupt();
        }
    }
}
```

Let's bring 10 customers to our barbershop:

```
Barbershop bs = new Barbershop(3);

for (int i = 1; i <= 10; i++) {
    BarbershopCustomer bc = new BarbershopCustomer(bs, i);
    new Thread(bc).start();
}
```

Here is a snapshot of a possible output:

```
[16:36:17] [INFO] Customer #10 is trying to get a seat
[16:36:17] [INFO] Customer #5 is trying to get a seat
[16:36:17] [INFO] Customer #7 is trying to get a seat
[16:36:17] [INFO] Customer #5 got a seat
[16:36:17] [INFO] Customer #10 got a seat
[16:36:19] [INFO] Customer #10 has released a seat
...
```

A permit is not acquired on a thread basis.



This means that the T1 thread can acquire a permit from a Semaphore and the T2 thread can release it. Of course, the developer is responsible for managing the process.

212. Phasers

A *phaser* is a flexible Java synchronizer that combines the functionalities of `CyclicBarrier` and `CountDownLatch` in the following context:

- A phaser is made of one or multiple phases that act as barriers for a dynamic number of parties (threads).
- During a phaser lifespan, the number of synchronized parties (threads) can be modified dynamically. We can register/deregister parties.
- The currently-registered parties must wait in the current phase (barrier) before going to the next step of execution (next phase)—as in the case of `CyclicBarrier`.
- Each phase of a phaser can be identified via an associated number/index starting from 0. The first phase is 0, the next phase is 1, the next phase is 2, and so on until `Integer.MAX_VALUE`.
- A phaser can have three types of parties in any of its phases: *registered*, *arrived* (these are registered parties waiting at the current phase/barrier), and *unarrived* (these are registered parties on the way to the current phase).
- There are three types of dynamic counters for parties: a counter for registered parties, a counter for arrived parties, and a counter for unarrived parties. When all parties arrive at the current phase (the number of registered parties is equal to the number of arrived parties), the phaser will advance to the next phase.
- Optionally, we can execute an action (snippet of code) right before advancing to the next phase (when all the parties arrive at the phase/barrier).
- A phaser has a termination state. Counts of registered parties are unaffected by termination, but after termination, all synchronization methods immediately return without waiting to advance to another phase. Similarly, attempts to register upon termination have no effect.

In the following diagram, we can see a phaser with four registered parties in phase 0, and three registered parties in phase 1. We also have some API flavors that are discussed further:

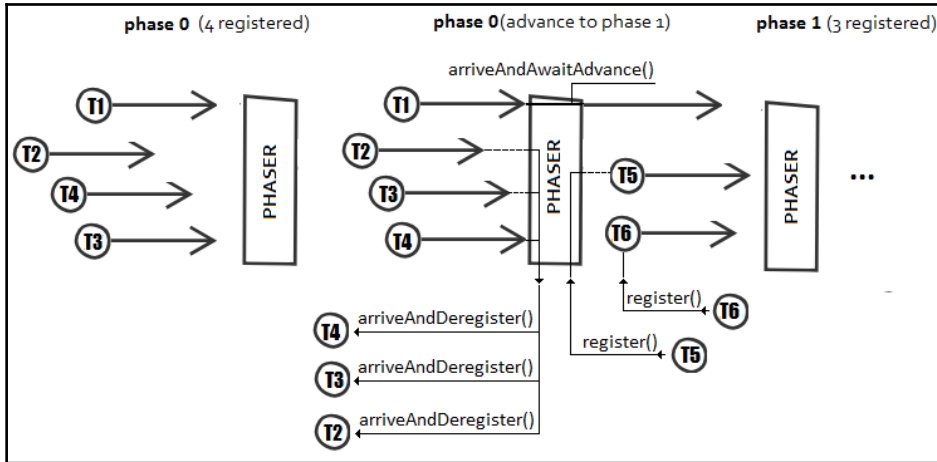

Commonly, by parties, we understand threads (one party = one thread), but a phaser doesn't perform an association between a party and a specific thread. A phaser just counts and manages the number of registered and deregistered parties.

In API terms, this synchronizer is represented by `java.util.concurrent.Phaser`.

A `Phaser` can be created with zero parties, an explicit number of parties via an empty constructor, or a constructor that takes an integer argument, `Phaser(int parties)`. A `Phaser` can also have a parent specified via `Phaser(Phaser parent)` or `Phaser(Phaser parent, int parties)`. It's common to start a `Phaser` with a single party, known as the controller or control-party. Usually, this party lives the longest during the `Phaser` lifespan.

A party can be registered any time via the `register()` method (in the preceding diagram, between phase 0 and phase 1, we register T5 and T6). We can also register a bulk of parties via `bulkRegister(int parties)`. A registered party can be deregistered without waiting for other parties via `arriveAndDeregister()`. This method allows a party to arrive at the current barrier (`Phaser`) and deregisters it without waiting for other parties to arrive (in the preceding diagram, the T4, T3, and T2 parties are deregistered one by one). Each deregistered party decreases the number of registered parties by one.

In order to arrive at the current phase (barrier) and wait for other parties to arrive, we need to call the `arriveAndAwaitAdvance()` method. This method blocks until all registered parties arrive at the current phase. All parties will advance to the next phase of this `Phaser` once the last registered party arrives at the current phase.

Optionally, when all registered parties arrive at the current phase, we can run a specific action by overriding the `onAdvance()` method, `onAdvance(int phase, int registeredParties)`. This method returns a boolean value which is `true` if we want to trigger the termination of `Phaser`. In addition, we can force the termination via `forceTermination()`, and we can test it via the flag method, `isTerminated()`. Overriding the `onAdvance()` method requires us to extend the `Phaser` class (usually, via an anonymous class).

At this moment, we should have enough details to solve our problem. So, we have to simulate the start process of a server in three phases of a `Phaser`. The server is considered started and running after its five internal services have started. In the first phase, we need to concurrently start three services. In the second phase, we need to concurrently start two more services (these can be started only if the first three are already running). In phase three, the server performs a final check-in and is considered started and running.

So, the thread (party) that manages the server-starting process can be considered the thread that controls the rest of the threads (parties). This means that we can create the `Phaser` and register this control thread (or, controller) via the `Phaser` constructor:

```
public class ServerInstance implements Runnable {

    private static final Logger logger =
        Logger.getLogger(ServerInstance.class.getName());

    private final Phaser phaser = new Phaser(1) {

        @Override
        protected boolean onAdvance(int phase, int registeredParties) {
            logger.warning(() -> "Phase: " + phase
                + " Registered parties: " + registeredParties);

            return registeredParties == 0;
        }
    };
    ...
}
```

Using an anonymous class, we create this `Phaser` object and override its `onAdvance()` method to define an action that has two main purposes:

- Print a quick status of the current phase and number of registered parties
- If there are no more registered parties, trigger the `Phaser` termination

This method will be called for every phase when all the currently-registered parties arrive at the current barrier (current phase).

The threads that manage the server's services need to start these services and to deregister themselves from the `Phaser`. So, each service is started in a separate thread that will deregister at the end of its job via `arriveAndDeregister()`. For this, we can use the following `Runnable`:

```
public class ServerService implements Runnable {

    private static final Logger logger =
        Logger.getLogger(ServerService.class.getName());

    private final String serviceName;
    private final Phaser phaser;
    private final Random rnd = new Random();

    public ServerService(Phaser phaser, String serviceName) {
        this.phaser = phaser;
        this.serviceName = serviceName;
        this.phaser.register();
    }

    @Override
    public void run() {

        int startingIn = rnd.nextInt(10) * 1000;

        try {
            logger.info(() -> "Starting service '" + serviceName + "' ...");
            Thread.sleep(startingIn);
            logger.info(() -> "Service '" + serviceName
                + "' was started in " + startingIn / 1000
                + " seconds (waiting for remaining services)");
        } catch (InterruptedException ex) {
            Thread.currentThread().interrupt();
            logger.severe(() -> "Exception: " + ex);
        } finally {
            phaser.arriveAndDeregister();
        }
    }
}
```

```
    }  
}
```

Now, the control thread can trigger the start process for `service1`, `service2`, and `service3`. This process is shaped in the following method:

```
private void startFirstThreeServices() {  
  
    Thread service1 = new Thread(  
        new ServerService(phaser, "HTTP Listeners"));  
    Thread service2 = new Thread(  
        new ServerService(phaser, "JMX"));  
    Thread service3 = new Thread(  
        new ServerService(phaser, "Connectors"));  
  
    service1.start();  
    service2.start();  
    service3.start();  
  
    phaser.arriveAndAwaitAdvance(); // phase 0  
}
```

Notice that, at the end of this method, we call `phaser.arriveAndAwaitAdvance()`. This is the control-party that waits for the rest of the registered parties to arrive. The rest of the registered parties (`service1`, `service2`, and `service3`) are deregistered one by one until the control-party is the only one left in `Phaser`. At this point, it's time to advance to the next phase. So, the control-party is the only one that advances to the next phase.

Similar to this implementation, the control thread can trigger the start process for `service4` and `service5`. This process is shaped in the following method:

```
private void startNextTwoServices() {  
  
    Thread service4 = new Thread(  
        new ServerService(phaser, "Virtual Hosts"));  
    Thread service5 = new Thread(  
        new ServerService(phaser, "Ports"));  
  
    service4.start();  
    service5.start();  
  
    phaser.arriveAndAwaitAdvance(); // phase 1  
}
```

Finally, after these five services are started, the control thread performs one last check that was implemented in the following method as a dummy `Thread.sleep()`. Notice that, at the end of this action, the control thread that has started the server deregistered itself from the `Phaser`. When this happens, it means there are no more registered parties and the `Phaser` is terminated as a result of returning `true` from the `onAdvance()` method:

```
private void finalCheckIn() {  
  
    try {  
        logger.info("Finalizing process (should take 2 seconds) ...");  
        Thread.sleep(2000);  
    } catch (InterruptedException ex) {  
        Thread.currentThread().interrupt();  
        logger.severe(() -> "Exception: " + ex);  
    } finally {  
        phaser.arriveAndDeregister(); // phase 2  
    }  
}
```

The job of the control thread is to call the preceding three methods in the proper order. The rest of the code consists of some logs; therefore it was skipped for brevity. The complete source code of this problem is bundled with this book.



At any time, we can find out the number of registered parties via `getRegisteredParties()`, the number of arrived parties via `getArrivedParties()`, and the number of unarrived parties via `getUnarrivedParties()`. You might also want to check the `arrive()`, `awaitAdvance(int phase)`, and `awaitAdvanceInterruptibly(int phase)` methods.

Summary

This chapter outlined the main coordinates of Java concurrency and should prepare you for the next chapter. We covered several fundamental problems about thread life cycles, object- and class-level locking, thread pools, and `Callable` and `Future`.

Download the applications from this chapter to see the results and to check out some additional details.

11

Concurrency - Deep Dive

This chapter includes 13 problems that involve Java concurrency, covering areas such as the fork/join framework, `CompletableFuture`, `ReentrantLock`, `ReentrantReadWriteLock`, `StampedLock`, atomic variables, tasks cancellation, interruptible methods, thread-local, and deadlocks. Concurrency is one of the required topics for any developer and can't be ignored at a job interview. That's why this chapter and the last one are so important. On finishing this chapter, you'll have a considerable understanding of concurrency, which every Java developer needs.

Problems

Use the following problems to test your concurrency programming prowess. I strongly encourage you to give each problem a try before you turn to the solutions and download the example programs:

213. **Interruptible methods:** Write a program that exemplifies the best approach for dealing with an interruptible method.
214. **Fork/join framework:** Write a program that relies on the fork/join framework to sum the elements of a list. Write a program that relies on the fork/join framework to compute the Fibonacci number at a given position (for example, $F_{12} = 144$). In addition, write a program that exemplifies the usage of `CountedCompleter`.
215. **Fork/join framework and `compareAndSetForkJoinTaskTag()`:** Write a program that applies the fork/join framework to a suite of interdependent tasks that should be executed only once (for example, *task D* depends on *task C* and *task B*, but *task C* depends on *task B* as well; therefore, *task B* must be executed only once, not twice).

216. `CompletableFuture`: Write several snippets of code to exemplify asynchronous code via `CompletableFuture`.
217. **Combining multiple `CompletableFuture` objects**: Write several snippets of code to exemplify different solutions for combining multiple `CompletableFuture` objects together.
218. **Optimizing busy waiting**: Write a proof of concept to exemplify the optimization of a *busy waiting* technique via `onSpinWait()`.
219. **Task cancellation**: Write a proof of concept that exemplifies the usage of a volatile variable for holding the cancellation state of a process.
220. `ThreadLocal`: Write a proof of concept that exemplifies the usage of `ThreadLocal`.
221. **Atomic variables**: Write a program that counts the integers from 1 to 1,000,000 using a multithreaded application (`Runnable`).
222. `ReentrantLock`: Write a program that increments the integers from 1 to 1,000,000 using `ReentrantLock`.
223. `ReentrantReadWriteLock`: Write a program that simulates the orchestration of a read-write process via `ReentrantReadWriteLock`.
224. `StampedLock`: Write a program that simulates the orchestration of a read-write process via `StampedLock`.
225. **Deadlock (dining philosophers)**: Write a program that reveals and solves the deadlock (*circular wait* or *deadly embrace*) that may occur in the famous dining philosophers problem.

Solutions

The following sections describe solutions to the preceding problems. Remember that there usually isn't a single correct way to solve a particular problem. Also, remember that the explanations shown here include only the most interesting and important details needed to solve the problems. Download the example solutions to see additional details and to experiment with the programs at <https://github.com/PacktPublishing/Java-Coding-Problems>.

213. Interruptible methods

By an interruptible method, we mean a blocking method that may throw `InterruptedException`, for example, `Thread.sleep()`, `BlockingQueue.take()`, `BlockingQueue.poll(long timeout, TimeUnit unit)`, and so on. A blocking thread is usually in a **BLOCKED**, **WAITING**, or **TIMED_WAITING** state, and, if it is interrupted, then the method tries to throw `InterruptedException` as soon as possible.

Since `InterruptedException` is a checked exception, we must catch it and/or throw it. In other words, if our method calls a method that throws `InterruptedException`, then we must be prepared to deal with this exception. If we can throw it (propagate the exception to the caller), then it is not our job anymore. The caller has to deal with it further. So, let's focus on the case when we must catch it. Such a case can occur when our code is run inside `Runnable`, which cannot throw an exception.

Let's start with a simple example. Trying to get an element from `BlockingQueue` via `poll(long timeout, TimeUnit unit)` can be written as follows:

```
try {
    queue.poll(3000, TimeUnit.MILLISECONDS);
} catch (InterruptedException ex) {
    ...
    logger.info() -> "Thread is interrupted? "
        + Thread.currentThread().isInterrupted();
}
```

Attempting to poll an element from the queue can result in `InterruptedException`. There is a window of 3,000 milliseconds in which the thread can be interrupted. In case of an interruption (for example, `Thread.interrupt()`), we may be tempted to think that calling `Thread.currentThread().isInterrupted()` in the catch block will return `true`. After all, we are in an `InterruptedException` catch block, so it makes sense to believe this. Actually, it will return `false`, and the answer is in the source code of the `poll(long timeout, TimeUnit unit)` method listed as follows:

```
1: public E poll(long timeout, TimeUnit unit)
    throws InterruptedException {
2:     E e = xfer(null, false, TIMED, unit.toNanos(timeout));
3:     if (e != null || !Thread.interrupted())
4:         return e;
5:     throw new InterruptedException();
6: }
```

More precisely, the answer is in line 3. If the thread was interrupted then `Thread.interrupted()` will return `true` and will lead to line 5 (`throw new InterruptedException()`). But beside testing, if the current thread was interrupted, `Thread.interrupted()` clears the interrupted status of the thread. Check out the following succession of calls for an interrupted thread:

```
Thread.currentThread().isInterrupted(); // true
Thread.interrupted() // true
Thread.currentThread().isInterrupted(); // false
Thread.interrupted() // false
```

Notice that `Thread.currentThread().isInterrupted()` tests whether this thread has been interrupted without affecting the interrupted status.

Now, let's get back to our case. So, we know that the thread was interrupted since we caught `InterruptedException`, but the interrupted status was cleared by `Thread.interrupted()`. This means also that the caller of our code will not be aware of the interruption.

It is our responsibility to be good citizens and restore the interrupt by calling the `interrupt()` method. This way, the caller of our code can see that an interrupt was issued and act accordingly. The correct code could be as follows:

```
try {
    queue.poll(3000, TimeUnit.MILLISECONDS);
} catch (InterruptedException ex) {
    ...
    Thread.currentThread().interrupt(); // restore interrupt
}
```



As a rule of thumb, after catching `InterruptedException`, do not forget to restore the interrupt by calling `Thread.currentThread().interrupt()`.

Let's tackle a problem that highlights the case of forgetting to restore the interrupt. Let's assume a `Runnable` that runs as long as the current thread is not interrupted (for example, `while (!Thread.currentThread().isInterrupted()) { ... }`).

At each iteration, if the current thread interrupted status is `false`, then we try to get an element from `BlockingQueue`.

The following code is the implementation:

```
Thread thread = new Thread(() -> {

    // some dummy queue
    TransferQueue<String> queue = new LinkedTransferQueue<>();

    while (!Thread.currentThread().isInterrupted()) {
        try {
            logger.info(() -> "For 3 seconds the thread "
                + Thread.currentThread().getName()
                + " will try to poll an element from queue ...");

            queue.poll(3000, TimeUnit.MILLISECONDS);
        } catch (InterruptedException ex) {
            logger.severe(() -> "InterruptedException! The thread "
                + Thread.currentThread().getName() + " was interrupted!");
            Thread.currentThread().interrupt();
        }
    }

    logger.info(() -> "The execution was stopped!");
});
```

As a caller (another thread), we start the above thread, sleep for 1.5 seconds, just to give time to this thread to enter in the `poll()` method, and we interrupt it. This is shown in the following code:

```
thread.start();
Thread.sleep(1500);
thread.interrupt();
```

This will lead to `InterruptedException`.

The exception is logged and the interrupt is restored.

At the next step, while evaluates `Thread.currentThread().isInterrupted()` to false and exits.

As a result, the output will be as follows:

```
[18:02:43] [INFO] For 3 seconds the thread Thread-0
                will try to poll an element from queue ...

[18:02:44] [SEVERE] InterruptedException!
                The thread Thread-0 was interrupted!

[18:02:45] [INFO] The execution was stopped!
```

Now, let's comment on the line that restores the interrupt:

```
...
} catch (InterruptedException ex) {
    logger.severe() -> "InterruptedException! The thread "
        + Thread.currentThread().getName() + " was interrupted!";

    // notice that the below line is commented
    // Thread.currentThread().interrupt();
}
...
```

This time, the `while` block will run forever since its guarding condition is always evaluated to `true`.

The code cannot act on the interruption, so the output will be as follows:

```
[18:05:47] [INFO] For 3 seconds the thread Thread-0
                will try to poll an element from queue ...

[18:05:48] [SEVERE] InterruptedException!
                The thread Thread-0 was interrupted!

[18:05:48] [INFO] For 3 seconds the thread Thread-0
                will try to poll an element from queue ...

...
```



As a rule of thumb, the only acceptable case when we can swallow an interrupt (not restore the interrupt) is when we can control the entire call stack (for example, `extend Thread`).

Otherwise, catching `InterruptedException` should contain `Thread.currentThread().interrupt()` as well.

214. Fork/join framework

We've already had an introduction to the fork/join framework in the *Work-stealing thread pool* section.

Mainly, the fork/join framework is meant to take a big task (typically, by big we understand a large volume of data) and recursively split (fork) it into smaller tasks (subtasks) that can be performed in parallel. In the end, after all the subtasks have been completed, their results are combined (joined) in a single result.

The following diagram is a visual representation of a fork-join flow:

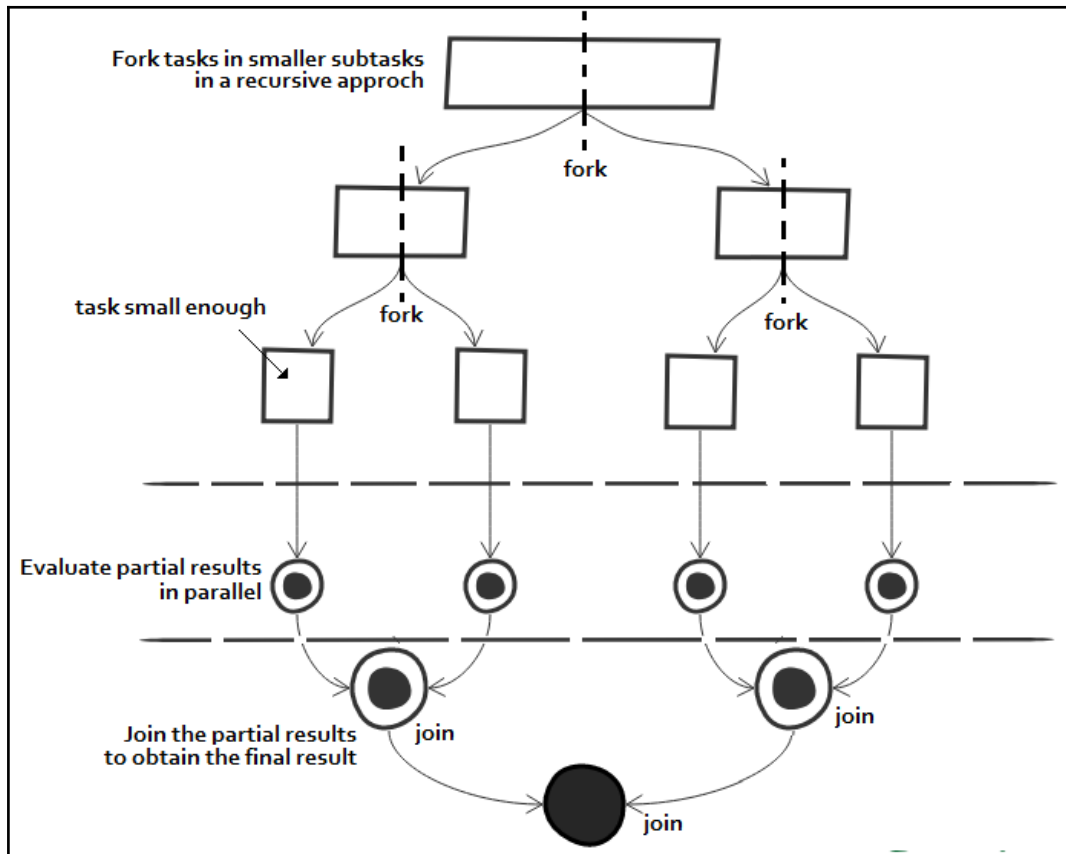

In API terms, a fork/join can be created via `java.util.concurrent.ForkJoinPool`.

Before JDK 8, the recommended approach relied on a public static variable as follows:

```
public static ForkJoinPool forkJoinPool = new ForkJoinPool();
```

Starting with JDK 8, we can do it as follows:

```
ForkJoinPool forkJoinPool = ForkJoinPool.commonPool();
```

Both approaches avoid the unpleasant situation of having too many pool threads on a single JVM, caused by the parallel operations that created their own pools.



For a custom `ForkJoinPool`, rely on the constructors of this class. JDK 9 has added the most comprehensive one so far (details are available in the documentation).

A `ForkJoinPool` object manipulates tasks. The base type of task executed in `ForkJoinPool` is `ForkJoinTask<V>`. More precisely, the following tasks are executed:

- `RecursiveAction` for the void tasks
- `RecursiveTask<V>` for tasks that return a value
- `CountedCompleter<T>` for tasks that need to remember the pending task count

All three types of tasks have an abstract method named `compute()` in which the task's logic is shaped.

Submitting tasks to `ForkJoinPool` can be accomplished via the following:

- `execute()` and `submit()`
- `invoke()` for forking the task and waiting for the result
- `invokeAll()` for forking a bunch of tasks (for example, a collection)
- `fork()` for arranging to asynchronously execute this task in the pool, and `join()` for returning the result of the computation when it is done

Let's start with a problem solved via `RecursiveTask`.

Computing the sum via `RecursiveTask`

To demonstrate the forking behavior of the framework, let's assume that we have a list of numbers and we want to compute the sum of these numbers. For this, we recursively split (fork) this list as long as it is larger than the specified `THRESHOLD` using the `createSubtasks()` method. Each task is added into `List<SumRecursiveTask>`. In the end, this list is submitted to `ForkJoinPool` via the `invokeAll(Collection<T> tasks)` method. This is done using the following code:

```
public class SumRecursiveTask extends RecursiveTask<Integer> {  
  
    private static final Logger logger  
        = Logger.getLogger(SumRecursiveTask.class.getName());
```

```
private static final int THRESHOLD = 10;

private final List<Integer> worklist;

public SumRecursiveTask(List<Integer> worklist) {
    this.worklist = worklist;
}

@Override
protected Integer compute() {
    if (worklist.size() <= THRESHOLD) {
        return partialSum(worklist);
    }

    return ForkJoinTask.invokeAll(createSubtasks()
        .stream()
        .mapToInt(ForkJoinTask::join)
        .sum());
}

private List<SumRecursiveTask> createSubtasks() {

    List<SumRecursiveTask> subtasks = new ArrayList<>();
    int size = worklist.size();

    List<Integer> worklistLeft
        = worklist.subList(0, (size + 1) / 2);
    List<Integer> worklistRight
        = worklist.subList((size + 1) / 2, size);

    subtasks.add(new SumRecursiveTask(worklistLeft));
    subtasks.add(new SumRecursiveTask(worklistRight));

    return subtasks;
}

private Integer partialSum(List<Integer> worklist) {

    int sum = worklist.stream()
        .mapToInt(e -> e)
        .sum();

    logger.info(() -> "Partial sum: " + worklist + " = "
        + sum + "\tThread: " + Thread.currentThread().getName());

    return sum;
}
}
```

In order to test it, we need a list and `ForkJoinPool` as follows:

```
ForkJoinPool forkJoinPool = ForkJoinPool.commonPool();

Random rnd = new Random();
List<Integer> list = new ArrayList<>();

for (int i = 0; i < 200; i++) {
    list.add(1 + rnd.nextInt(10));
}

SumRecursiveTask sumRecursiveTask = new SumRecursiveTask(list);
Integer sumAll = forkJoinPool.invoke(sumRecursiveTask);

logger.info(() -> "Final sum: " + sumAll);
```

A possible output will be the following:

```
...
[15:17:06] Partial sum: [1, 3, 6, 6, 2, 5, 9] = 32
ForkJoinPool.commonPool-worker-9
...
[15:17:06] Partial sum: [1, 9, 9, 8, 9, 5] = 41
ForkJoinPool.commonPool-worker-7
[15:17:06] Final sum: 1084
```

Computing Fibonacci via RecursiveAction

Commonly denoted as F_n , the Fibonacci numbers are a sequence that respects the following formula:

$$F_0=0, F_1 = 1, \dots F_n = F_{n-1} + F_{n-2} \quad (n > 1)$$

A snapshot of Fibonacci numbers is:

0, 1, 1, 2, 3, 5, 8, 13, 21, 34, 55, 89, 144, ...

The implementation of Fibonacci numbers via `RecursiveAction` can be accomplished as follows:

```
public class FibonacciRecursiveAction extends RecursiveAction {

    private static final Logger logger =
        Logger.getLogger(FibonacciRecursiveAction.class.getName());
    private static final long THRESHOLD = 5;
```

```
private long nr;

public FibonacciRecursiveAction(long nr) {
    this.nr = nr;
}

@Override
protected void compute() {

    final long n = nr;

    if (n <= THRESHOLD) {
        nr = fibonacci(n);
    } else {
        nr = ForkJoinTask.invokeAll(createSubtasks(n))
            .stream()
            .mapToLong(x -> x.fibonacciNumber())
            .sum();
    }
}

private List<FibonacciRecursiveAction> createSubtasks(long n) {

    List<FibonacciRecursiveAction> subtasks = new ArrayList<>();

    FibonacciRecursiveAction fibonacciMinusOne
        = new FibonacciRecursiveAction(n - 1);
    FibonacciRecursiveAction fibonacciMinusTwo
        = new FibonacciRecursiveAction(n - 2);

    subtasks.add(fibonacciMinusOne);
    subtasks.add(fibonacciMinusTwo);

    return subtasks;
}

private long fibonacci(long n) {
    logger.info(() -> "Number: " + n
        + " Thread: " + Thread.currentThread().getName());

    if (n <= 1) {
        return n;
    }

    return fibonacci(n - 1) + fibonacci(n - 2);
}

public long fibonacciNumber() {
```



```

        return nr;
    }
}

```

In order to test it, we need the following `ForkJoinPool` object:

```

ForkJoinPool forkJoinPool = ForkJoinPool.commonPool();

FibonacciRecursiveAction fibonacciRecursiveAction
    = new FibonacciRecursiveAction(12);
forkJoinPool.invoke(fibonacciRecursiveAction);

logger.info(() -> "Fibonacci: "
    + fibonacciRecursiveAction.fibonacciNumber());

```

The output for F_{12} is as follows:

```

[15:40:46] Number: 5 Thread: ForkJoinPool.commonPool-worker-3
[15:40:46] Number: 5 Thread: ForkJoinPool.commonPool-worker-13
[15:40:46] Number: 4 Thread: ForkJoinPool.commonPool-worker-3
[15:40:46] Number: 4 Thread: ForkJoinPool.commonPool-worker-9
...
[15:40:49] Number: 0 Thread: ForkJoinPool.commonPool-worker-7
[15:40:49] Fibonacci: 144

```

Using CountedCompleter

`CountedCompleter` is a type of `ForkJoinTask` added in JDK 8.

The job of `CountedCompleter` is to remember the pending task count (nothing less, nothing more). We can set the pending count via `setPendingCount()` or increment it with an explicit delta via `addToPendingCount(int delta)`. Commonly, we call these methods right before forking (for example, if we fork twice, then we call `addToPendingCount(2)` or `setPendingCount(2)`, depending on the case).

In the `compute()` method, we decrease the pending count via `tryComplete()` or `propagateCompletion()`. When the `tryComplete()` method is called, with a pending count of zero, or the unconditional `complete()` method is called, the `onCompletion()` method is called. The `propagateCompletion()` method is similar with `tryComplete()`, but it doesn't call `onCompletion()`.

CountedCompleter can optionally return a computed value. For this, we have to override the `getRawResult()` method to return a value.

The following code sums up all the values of a list via `CountedCompleter`:

```
public class SumCountedCompleter extends CountedCompleter<Long> {

    private static final Logger logger
        = Logger.getLogger(SumCountedCompleter.class.getName());
    private static final int THRESHOLD = 10;
    private static final LongAdder sumAll = new LongAdder();

    private final List<Integer> worklist;

    public SumCountedCompleter(
        CountedCompleter<Long> c, List<Integer> worklist) {
        super(c);
        this.worklist = worklist;
    }

    @Override
    public void compute() {
        if (worklist.size() <= THRESHOLD) {
            partialSum(worklist);
        } else {
            int size = worklist.size();

            List<Integer> worklistLeft
                = worklist.subList(0, (size + 1) / 2);
            List<Integer> worklistRight
                = worklist.subList((size + 1) / 2, size);

            addToPendingCount(2);
            SumCountedCompleter leftTask
                = new SumCountedCompleter(this, worklistLeft);
            SumCountedCompleter rightTask
                = new SumCountedCompleter(this, worklistRight);

            leftTask.fork();
            rightTask.fork();
        }

        tryComplete();
    }

    @Override
    public void onCompletion(CountedCompleter<?> caller) {
        logger.info(() -> "Thread complete: ")
    }
}
```

```
        + Thread.currentThread().getName());
    }

    @Override
    public Long getRawResult() {
        return sumAll.sum();
    }

    private Integer partialSum(List<Integer> worklist) {
        int sum = worklist.stream()
            .mapToInt(e -> e)
            .sum();

        sumAll.add(sum);

        logger.info(() -> "Partial sum: " + worklist + " = "
            + sum + "\tThread: " + Thread.currentThread().getName());

        return sum;
    }
}
```

Now, let's see a potential call and output:

```
ForkJoinPool forkJoinPool = ForkJoinPool.commonPool();
Random rnd = new Random();
List<Integer> list = new ArrayList<>();

for (int i = 0; i < 200; i++) {
    list.add(1 + rnd.nextInt(10));
}

SumCountedCompleter sumCountedCompleter
    = new SumCountedCompleter(null, list);
forkJoinPool.invoke(sumCountedCompleter);

logger.info(() -> "Done! Result: "
    + sumCountedCompleter.getRawResult());
```

The output will be as follows:

```
[11:11:07] Partial sum: [7, 7, 8, 5, 6, 10] = 43
    ForkJoinPool.commonPool-worker-7
[11:11:07] Partial sum: [9, 1, 1, 6, 1, 2] = 20
    ForkJoinPool.commonPool-worker-3
...
[11:11:07] Thread complete: ForkJoinPool.commonPool-worker-15
[11:11:07] Done! Result: 1159
```

215. Fork/join framework and `compareAndSetForkJoinTaskTag()`

Now, that we are familiar with the fork/join framework, let's see another problem. This time let's assume that we have a suite of `ForkJoinTask` objects that are interdependent. The following diagram can be considered a use case:

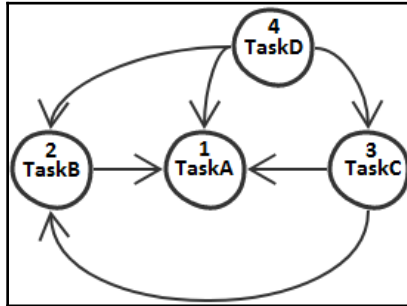

Here is the description of the preceding diagram:

- **TaskD** has three dependencies: **TaskA**, **TaskB**, and **TaskC**.
- **TaskC** has two dependencies: **TaskA** and **TaskB**.
- **TaskB** has one dependency: **TaskA**.
- **TaskA** has no dependencies.

In code lines, we will shape it as follows:

```
ForkJoinPool forkJoinPool = ForkJoinPool.commonPool();

Task taskA = new Task("Task-A", new Adder(1));

Task taskB = new Task("Task-B", new Adder(2), taskA);

Task taskC = new Task("Task-C", new Adder(3), taskA, taskB);

Task taskD = new Task("Task-D", new Adder(4), taskA, taskB, taskC);

forkJoinPool.invoke(taskD);
```

An `Adder` is a simple `Callable` that should be executed only once for each task (so, once for **TaskD**, **TaskC**, **TaskB**, and **TaskA**). The `Adder` is initiated in the following code:

```
private static class Adder implements Callable {

    private static final AtomicInteger result = new AtomicInteger();

    private Integer nr;

    public Adder(Integer nr) {
        this.nr = nr;
    }

    @Override
    public Integer call() {
        logger.info() -> "Adding number: " + nr
            + " by thread:" + Thread.currentThread().getName();

        return result.addAndGet(nr);
    }
}
```

We already know how to use the `fork/join` framework for tasks with acyclic and/or non-repeatable (or we don't care that they repeat) completion dependencies. But if we implement it this way then `Callable` will be called more than once per task. For example, **TaskA** appears as a dependency for three other tasks, so `Callable` will be invoked three times. We want it only once.

A very handy feature of `ForkJoinPool` added in JDK 8 consists of atomically tagging with a short value:

- `short getForkJoinTaskTag():` Returns the tag for this task.
- `short setForkJoinTaskTag(short newValue):` Atomically sets the tag value for this task and returns the old value.
- `boolean compareAndSetForkJoinTaskTag(short expect, short update):` Returns `true` if the current value was equal to `expect` and was changed to `update`.

In other words, `compareAndSetForkJoinTaskTag()` allows us to tag a task as `VISITED`. Once it is tagged as `VISITED`, it will not be executed. Let's see it in the following code lines:

```
public class Task<Integer> extends RecursiveTask<Integer> {

    private static final Logger logger
        = Logger.getLogger(Task.class.getName());
    private static final short UNVISITED = 0;
    private static final short VISITED = 1;

    private Set<Task<Integer>> dependencies = new HashSet<>();

    private final String name;
    private final Callable<Integer> callable;

    public Task(String name, Callable<Integer> callable,
        Task<Integer> ...dependencies) {
        this.name = name;
        this.callable = callable;
        this.dependencies = Set.of(dependencies);
    }

    @Override
    protected Integer compute() {
        dependencies.stream()
            .filter((task) -> (task.updateTaskAsVisited()))
            .forEachOrdered((task) -> {
                logger.info(() -> "Tagged: " + task + "("
                    + task.getForkJoinTaskTag() + ")");

                task.fork();
            });

        for (Task task: dependencies) {
            task.join();
        }

        try {
            return callable.call();
        } catch (Exception ex) {
            logger.severe(() -> "Exception: " + ex);
        }

        return null;
    }

    public boolean updateTaskAsVisited() {
```

```
        return compareAndSetForkJoinTaskTag(UNVISITED, VISITED);
    }

    @Override
    public String toString() {
        return name + " | dependencies=" + dependencies + " ";
    }
}
```

And, a possible output could be the following:

```
[10:30:53] [INFO] Tagged: Task-B(1)
[10:30:53] [INFO] Tagged: Task-C(1)
[10:30:53] [INFO] Tagged: Task-A(1)
[10:30:53] [INFO] Adding number: 1
                    by thread:ForkJoinPool.commonPool-worker-3
[10:30:53] [INFO] Adding number: 2
                    by thread:ForkJoinPool.commonPool-worker-3
[10:30:53] [INFO] Adding number: 3
                    by thread:ForkJoinPool.commonPool-worker-5
[10:30:53] [INFO] Adding number: 4
                    by thread:main
[10:30:53] [INFO] Result: 10
```

216. CompletableFuture

JDK 8 has made a significant step forward in the world of asynchronous programming by enhancing `Future` with `CompletableFuture`. The main limitations of `Future` are:

- It cannot be explicitly complete.
- It doesn't support callbacks for performing actions on the result.
- They cannot be chained or combined for obtaining complex asynchronous pipelines.
- It doesn't provide exception handling.

A `CompletableFuture` doesn't have these limitations. A simple, but useless `CompletableFuture` can be written as follows:

```
CompletableFuture<Integer> completableFuture
    = new CompletableFuture<>();
```

The result can be obtained via the blocking `get ()` method:

```
completableFuture.get ();
```

In addition to this, let's see several examples of running asynchronous tasks in the context of an e-commerce platform. We add these examples in a helper class named `CustomerAsyncns`.

Running asynchronous task and return void

User problem: *Print a certain customer order.*

Since printing is a process that doesn't need to return a result, this is a job for `runAsync ()`. This method can run a task asynchronously and doesn't return a result. In other words, it takes a `Runnable` object and returns `CompletableFuture<Void>`; this is shown in the following code:

```
public static void printOrder() {

    CompletableFuture<Void> cfPrintOrder
        = CompletableFuture.runAsync(new Runnable() {

            @Override
            public void run() {
                logger.info(() -> "Order is printed by: "
                    + Thread.currentThread().getName());
                Thread.sleep(500);
            }
        });

    cfPrintOrder.get(); // block until the order is printed
    logger.info("Customer order was printed ...\\n");
}
```

Or, we can write it using a lambda:

```
public static void printOrder() {

    CompletableFuture<Void> cfPrintOrder
        = CompletableFuture.runAsync(() -> {

            logger.info(() -> "Order is printed by: "
                + Thread.currentThread().getName());
            Thread.sleep(500);
        });
}
```



```
cfPrintOrder.get(); // block until the order is printed
logger.info("Customer order was printed ...\n");
}
```

Running an asynchronous task and returning a result

User problem: *Fetch the order summary of a certain customer.*

This time, the asynchronous task must return a result, and so `runAsync()` is not useful. This is a job for `supplyAsync()`. It takes `Supplier<T>` and returns `CompletableFuture<T>`. `T` is the type of the result obtained from this supplier via the `get()` method. In code lines, we can solve this problem as follows:

```
public static void fetchOrderSummary() {
    CompletableFuture<String> cfOrderSummary
        = CompletableFuture.supplyAsync(() -> {
        logger.info(() -> "Fetch order summary by: "
            + Thread.currentThread().getName());
        Thread.sleep(500);

        return "Order Summary #93443";
    });

    // wait for summary to be available, this is blocking
    String summary = cfOrderSummary.get();
    logger.info(() -> "Order summary: " + summary + "\n");
}
```

Running an asynchronous task and returning a result via an explicit thread pool

User problem: *Fetch the order summary of a certain customer.*

By default, as in the preceding examples, the asynchronous tasks are executed in threads obtained from the global `ForkJoinPool.commonPool()`. By simply logging `Thread.currentThread().getName()`, we see something as `ForkJoinPool.commonPool-worker-3`.

But we can also use an explicit `Executor` custom thread pool. All the `CompletableFuture` methods that are capable of running asynchronous tasks provide a flavor that takes `Executor`.

Here is an example of using a single thread pool:

```
public static void fetchOrderSummaryExecutor() {
    ExecutorService executor = Executors.newSingleThreadExecutor();

    CompletableFuture<String> cfOrderSummary
        = CompletableFuture.supplyAsync(() -> {

        logger.info(() -> "Fetch order summary by: "
            + Thread.currentThread().getName());
        Thread.sleep(500);

        return "Order Summary #91022";
    }, executor);

    // wait for summary to be available, this is blocking
    String summary = cfOrderSummary.get();
    logger.info(() -> "Order summary: " + summary + "\n");
    executor.shutdownNow();
}
```

Attaching a callback that processes the result of an asynchronous task and returns a result

User problem: *Fetch the order invoice of a certain customer and, afterward, compute the total and sign it.*

Relying on blocking `get()` is not very useful for such problems. What we need is a callback method that will be automatically called when the result of `CompletableFuture` is available.

So, we don't want to wait for the result. When the invoice is ready (this is the result of `CompletableFuture`), a callback method should compute the total value, and, afterward, another callback should sign it. This can be achieved via the `thenApply()` method.

The `thenApply()` method is useful for processing and transforming the result of `CompletableFuture` when it arrives. It takes `Function<T, R>` as an argument. Let's see it at work:

```
public static void fetchInvoiceTotalSign() {

    CompletableFuture<String> cfFetchInvoice
        = CompletableFuture.supplyAsync(() -> {

        logger.info(() -> "Fetch invoice by: "
            + Thread.currentThread().getName());
        Thread.sleep(500);

        return "Invoice #3344";
    });

    CompletableFuture<String> cfTotalSign = cfFetchInvoice
        .thenApply(o -> o + " Total: $145")
        .thenApply(o -> o + " Signed");

    String result = cfTotalSign.get();
    logger.info(() -> "Invoice: " + result + "\n");
}
```

Or, we can chain it as follows:

```
public static void fetchInvoiceTotalSign() {

    CompletableFuture<String> cfTotalSign
        = CompletableFuture.supplyAsync(() -> {

        logger.info(() -> "Fetch invoice by: "
            + Thread.currentThread().getName());
        Thread.sleep(500);

        return "Invoice #3344";
    }).thenApply(o -> o + " Total: $145")
        .thenApply(o -> o + " Signed");

    String result = cfTotalSign.get();
    logger.info(() -> "Invoice: " + result + "\n");
}
```



Check also `applyToEither()` and `applyToEitherAsync()`. When either this or the other given stage completes in a normal way, these two methods return a new completion stage that is executed with the result as an argument to the supplied function.

Attaching a callback that processes the result of an asynchronous task and returns void

User problem: *Fetch the order of a certain customer and print it.*

Typically, a callback that doesn't return a result acts as a terminal action of an asynchronous pipeline.

This behavior can be obtained via the `thenAccept()` method. It takes `Consumer<T>` and returns `CompletableFuture<Void>`. This method can process and transform the result of `CompletableFuture`, but doesn't return a result. So, it can take an order, which is the result of `CompletableFuture`, and print it as shown in the following snippet of code:

```
public static void fetchAndPrintOrder() {

    CompletableFuture<String> cfFetchOrder
        = CompletableFuture.supplyAsync(() -> {

        logger.info(() -> "Fetch order by: "
            + Thread.currentThread().getName());
        Thread.sleep(500);

        return "Order #1024";
    });

    CompletableFuture<Void> cfPrintOrder = cfFetchOrder.thenAccept(
        o -> logger.info(() -> "Printing order " + o +
            " by: " + Thread.currentThread().getName()));

    cfPrintOrder.get();
    logger.info("Order was fetched and printed \n");
}
```

Or, it can be more compact as follows:

```
public static void fetchAndPrintOrder() {

    CompletableFuture<Void> cfFetchAndPrintOrder
        = CompletableFuture.supplyAsync(() -> {

        logger.info(() -> "Fetch order by: "
            + Thread.currentThread().getName());
        Thread.sleep(500);

        return "Order #1024";
    });
}
```

```

    }).thenAccept (
        o -> logger.info(() -> "Printing order " + o + " by: "
            + Thread.currentThread().getName()));

    cfFetchAndPrintOrder.get();
    logger.info("Order was fetched and printed \n");
}

```



Check also `acceptEither()` and `acceptEitherAsync()`.

Attaching a callback that runs after an asynchronous task and returns void

User problem: *Deliver an order and notify the customer.*

Notifying the customer should be accomplished after delivering the order. This is just an SMS of the *Dear customer, your order has been delivered today* type, so the notification task doesn't need to know anything about the order. These kinds of tasks can be accomplished by `thenRun()`. This method takes `Runnable` and returns `CompletableFuture<Void>`. Let's see it at work:

```

public static void deliverOrderNotifyCustomer() {

    CompletableFuture<Void> cfDeliverOrder
        = CompletableFuture.runAsync(() -> {

            logger.info(() -> "Order was delivered by: "
                + Thread.currentThread().getName());
            Thread.sleep(500);
        });

    CompletableFuture<Void> cfNotifyCustomer
        = cfDeliverOrder.thenRun(() -> logger.info(
            () -> "Dear customer, your order has been delivered today by:"
                + Thread.currentThread().getName()));

    cfNotifyCustomer.get();
    logger.info(() -> "Order was delivered
        and customer was notified \n");
}

```



For further parallelization, `thenApply()`, `thenAccept()`, and `thenRun()` are accompanied by `thenApplyAsync()`, `thenAcceptAsync()`, and `thenRunAsync()`. Each of these can rely on the global `ForkJoinPool.commonPool()` or a custom thread pool (`Executor`). While `thenApply/Accept/Run()` are executed in the same thread as the `CompletableFuture` task was executed before (or in the main thread), `thenApplyAsync/AcceptAsync/RunAsync()` may be executed in a different thread (from `ForkJoinPool.commonPool()` or a custom thread pool (`Executor`)).

Handling exceptions of an asynchronous task via `exceptionally()`

User problem: *Compute the total of an order. If something goes wrong, then throw an `IllegalStateException`.*

The following screenshots exemplify how exceptions are propagated in an asynchronous pipeline; the code in rectangles is not executed when an exception occurs at the point:

<pre>CompletableFuture.supplyAsync(() -> { // Code prone to exception return "result1"; }).thenApply(r1 -> { // Code prone to exception return "result2"; }).thenApply(r2 -> { // Code prone to exception return "result3"; }).thenAccept(r3 -> { // Code prone to exception });</pre>	<pre>CompletableFuture.supplyAsync(() -> { // Code prone to exception return "result1"; }).thenApply(r1 -> { // Code prone to exception return "result2"; }).thenApply(r2 -> { // Code prone to exception return "result3"; }).thenAccept(r3 -> { // Code prone to exception });</pre>
Exception in <code>supplyAsync()</code>	Exception in 1st <code>thenApply()</code>

The following screenshot shows the exceptions in `thenApply()` and `thenAccept()`:

<pre> CompletableFuture.supplyAsync(() -> { // Code prone to exception return "result1"; }).thenApply(r1 -> { // Code prone to exception return "result2"; }).thenApply(r2 -> { // Code prone to exception return "result3"; }).thenAccept(r3 -> { // Code prone to exception }); </pre>	<pre> CompletableFuture.supplyAsync(() -> { // Code prone to exception return "result1"; }).thenApply(r1 -> { // Code prone to exception return "result2"; }).thenApply(r2 -> { // Code prone to exception return "result3"; }).thenAccept(r3 -> { // Code prone to exception }); </pre>
Exception in 2nd thenApply()	Exception in thenAccept()

So, in `supplyAsync()`, if an exception occurs, then none of the following callbacks will be called. Moreover, the future will be resolved with this exception. The same rule applies for each callback. If the exception occurs in the first `thenApply()`, then the following `thenApply()` and `thenAccept()` will not be called.

If our attempt to computing the total of order ends up in an `IllegalStateException`, then we can rely on the `exceptionally()` callback which gives us a chance to recover. This method takes a `Function<Throwable, ? extends T>` and returns a `CompletionStage<T>`, therefore, a `CompletableFuture`. Let's see it at work:

```

public static void fetchOrderTotalException() {

    CompletableFuture<Integer> cfTotalOrder
        = CompletableFuture.supplyAsync(() -> {

            logger.info(() -> "Compute total: "
                + Thread.currentThread().getName());

            int surrogate = new Random().nextInt(1000);
            if (surrogate < 500) {
                throw new IllegalStateException(
                    "Invoice service is not responding");
            }

            return 1000;
        }).exceptionally(ex -> {
            logger.severe(() -> "Exception: " + ex
                + " Thread: " + Thread.currentThread().getName());
        });
}

```

```

        return 0;
    });

    int result = cfTotalOrder.get();
    logger.info(() -> "Total: " + result + "\n");
}

```

In case of exception, the output will be as follows:

```

Compute total: ForkJoinPool.commonPool-worker-3
Exception: java.lang.IllegalStateException: Invoice service
            is not responding Thread: ForkJoinPool.commonPool-worker-3
Total: 0

```

Let's take a look at another problem.

User problem: Fetch an invoice, compute the total, and sign. If something goes wrong then throw `IllegalStateException` and stop the process.

If we fetch the invoice using `supplyAsync()`, compute the total using `thenApply()` and sign using another `thenApply()`, then we may think that the right implementation is as follows:

```

public static void fetchInvoiceTotalSignChainOfException()
throws InterruptedException, ExecutionException {

    CompletableFuture<String> cfFetchInvoice
        = CompletableFuture.supplyAsync(() -> {

            logger.info(() -> "Fetch invoice by: "
                + Thread.currentThread().getName());

            int surrogate = new Random().nextInt(1000);
            if (surrogate < 500) {
                throw new IllegalStateException(
                    "Invoice service is not responding");
            }

            return "Invoice #3344";
        }).exceptionally(ex -> {
            logger.severe(() -> "Exception: " + ex
                + " Thread: " + Thread.currentThread().getName());

            return "[Invoice-Exception]";
        }).thenApply(o -> {
            logger.info(() -> "Compute total by: "
                + Thread.currentThread().getName());

```



```

    int surrogate = new Random().nextInt(1000);
    if (surrogate < 500) {
        throw new IllegalStateException(
            "Total service is not responding");
    }

    return o + " Total: $145";
}).exceptionally(ex -> {
    logger.severe(() -> "Exception: " + ex
        + " Thread: " + Thread.currentThread().getName());

    return "[Total-Exception]";
}).thenApply(o -> {
    logger.info(() -> "Sign invoice by: "
        + Thread.currentThread().getName());

    int surrogate = new Random().nextInt(1000);
    if (surrogate < 500) {
        throw new IllegalStateException(
            "Signing service is not responding");
    }

    return o + " Signed";
}).exceptionally(ex -> {
    logger.severe(() -> "Exception: " + ex
        + " Thread: " + Thread.currentThread().getName());

    return "[Sign-Exception]";
});

String result = cfFetchInvoice.get();
logger.info(() -> "Result: " + result + "\n");
}

```

Well, the issue here is that we may face an output as follows:

```

[INFO] Fetch invoice by: ForkJoinPool.commonPool-worker-3
[SEVERE] Exception: java.lang.IllegalStateException: Invoice service
        is not responding Thread: ForkJoinPool.commonPool-worker-3
[INFO] Compute total by: ForkJoinPool.commonPool-worker-3
[INFO] Sign invoice by: ForkJoinPool.commonPool-worker-3
[SEVERE] Exception: java.lang.IllegalStateException: Signing service
        is not responding Thread: ForkJoinPool.commonPool-worker-3
[INFO] Result: [Sign-Exception]

```

Even if the invoice couldn't be fetched, we would continue to compute the total and sign it. Obviously, this doesn't make sense. If the invoice cannot be fetched, or the total cannot be computed, then we expect to abort the process. While this implementation can be a good fit when we can recover and continue, it is definitely no good for our scenario. For our scenario, the following implementation is needed:

```
public static void fetchInvoiceTotalSignException()
throws InterruptedException, ExecutionException {

    CompletableFuture<String> cfFetchInvoice
        = CompletableFuture.supplyAsync(() -> {

        logger.info(() -> "Fetch invoice by: "
            + Thread.currentThread().getName());

        int surrogate = new Random().nextInt(1000);
        if (surrogate < 500) {
            throw new IllegalStateException(
                "Invoice service is not responding");
        }

        return "Invoice #3344";
    }).thenApply(o -> {
        logger.info(() -> "Compute total by: "
            + Thread.currentThread().getName());

        int surrogate = new Random().nextInt(1000);
        if (surrogate < 500) {
            throw new IllegalStateException(
                "Total service is not responding");
        }

        return o + " Total: $145";
    }).thenApply(o -> {
        logger.info(() -> "Sign invoice by: "
            + Thread.currentThread().getName());

        int surrogate = new Random().nextInt(1000);
        if (surrogate < 500) {
            throw new IllegalStateException(
                "Signing service is not responding");
        }

        return o + " Signed";
    }).exceptionally(ex -> {
        logger.severe(() -> "Exception: " + ex
            + " Thread: " + Thread.currentThread().getName());
```

```

        return "[No-Invoice-Exception]";
    });

    String result = cfFetchInvoice.get();
    logger.info(() -> "Result: " + result + "\n");
}

```

This time, an exception occurring in any of the implied `CompletableFuture` will stop the process. Here is a possible output:

```

[INFO ] Fetch invoice by: ForkJoinPool.commonPool-worker-3
[SEVERE] Exception: java.lang.IllegalStateException: Invoice service
        is not responding Thread: ForkJoinPool.commonPool-worker-3
[INFO ] Result: [No-Invoice-Exception]

```

Starting with JDK 12, the exceptional cases can be further parallelized via `exceptionallyAsync()` that can use the same thread as the code that caused the exception or a thread from the given thread pool (`Executor`). Here is an example:

```

public static void fetchOrderTotalExceptionAsync() {

    ExecutorService executor = Executors.newSingleThreadExecutor();

    CompletableFuture<Integer> totalOrder
        = CompletableFuture.supplyAsync(() -> {

        logger.info(() -> "Compute total by: "
            + Thread.currentThread().getName());

        int surrogate = new Random().nextInt(1000);
        if (surrogate < 500) {
            throw new IllegalStateException(
                "Computing service is not responding");
        }

        return 1000;
    }).exceptionallyAsync(ex -> {
        logger.severe(() -> "Exception: " + ex
            + " Thread: " + Thread.currentThread().getName());

        return 0;
    }, executor);

    int result = totalOrder.get();
    logger.info(() -> "Total: " + result + "\n");
    executor.shutdownNow();
}

```

The output reveals that the code that caused the exception was executed by a thread named `ForkJoinPool.commonPool-worker-3`, while the exceptional code was executed by a thread from the given thread pool named `pool-1-thread-1`:

```
Compute total by: ForkJoinPool.commonPool-worker-3
Exception: java.lang.IllegalStateException: Computing service is
           not responding Thread: pool-1-thread-1
Total: 0
```

JDK 12 exceptionallyCompose()

User problem: *Fetch a printer IP via the printing service or fallback to the backup printer IP. Or, generally speaking, when this stage completes exceptionally, it should be composed using the results of the supplied function applied to this stage's exception.*

We have `CompletableFuture` that fetches an IP of a printer managed by the printing service. If the service is not responding then it throws an exception as follows:

```
CompletableFuture<String> cfServicePrinterIp
    = CompletableFuture.supplyAsync(() -> {

        int surrogate = new Random().nextInt(1000);
        if (surrogate < 500) {
            throw new IllegalStateException(
                "Printing service is not responding");
        }

        return "192.168.1.0";
    });
```

We also have `CompletableFuture` that fetches the IP of the backup printer:

```
CompletableFuture<String> cfBackupPrinterIp
    = CompletableFuture.supplyAsync(() -> {

        return "192.192.192.192";
    });
```

Now, if the printing service is not available, then we should rely on the backup printer. This can be accomplished via the JDK 12 `exceptionallyCompose()` as follows:

```
CompletableFuture<Void> printInvoice
    = cfServicePrinterIp.exceptionallyCompose(th -> {

    logger.severe(() -> "Exception: " + th
        + " Thread: " + Thread.currentThread().getName());

    return cfBackupPrinterIp;
}).thenAccept((ip) -> logger.info(() -> "Printing at: " + ip));
```

Calling `printInvoice.get()` may reveal one of the following results:

- If the printing service is available:

```
[INFO] Printing at: 192.168.1.0
```

- If the printing service is not available:

```
[SEVERE] Exception: java.util.concurrent.CompletionException ...
[INFO] Printing at: 192.192.192.192
```

For further parallelization, we can rely on `exceptionallyComposeAsync()`.

Handling exceptions of an asynchronous task via `handle()`

User problem: *Compute the total of an order. If something goes wrong then throw an `IllegalStateException`.*

Sometimes we want to execute an exceptional block of code even if an exception did not occur. Like the `finally` clause of a `try-catch` block. This is possible using the `handle()` callback. This method is called whether or not an exception occurred, and is somehow like a `catch + finally`. It takes a function used to compute the value of the returned `CompletionStage`, `BiFunction<? super T, Throwable, ? extends U>` and returns `CompletionStage<U>` (`U` is the function's return type).

Let's see it at work:

```
public static void fetchOrderTotalHandle() {

    CompletableFuture<Integer> totalOrder
```

```

    = CompletableFuture.supplyAsync(() -> {

logger.info(() -> "Compute total by: "
    + Thread.currentThread().getName());

int surrogate = new Random().nextInt(1000);
if (surrogate < 500) {
    throw new IllegalStateException(
        "Computing service is not responding");
}

return 1000;
}).handle((res, ex) -> {
    if (ex != null) {
        logger.severe(() -> "Exception: " + ex
            + " Thread: " + Thread.currentThread().getName());

        return 0;
    }

    if (res != null) {
        int vat = res * 24 / 100;
        res += vat;
    }

    return res;
});

int result = totalOrder.get();
logger.info(() -> "Total: " + result + "\n");
}

```

Notice that `res` will be null; otherwise, the `ex` will be null if an exception occurs.

If we need to complete with an exception, then we can proceed via `completeExceptionally()` as in the following example:

```

CompletableFuture<Integer> cf = new CompletableFuture<>();
...
cf.completeExceptionally(new RuntimeException("Ops!"));
...
cf.get(); // ExecutionException : RuntimeException

```

Canceling the execution and throwing `CancellationException` can be done via the `cancel()` method:

```

CompletableFuture<Integer> cf = new CompletableFuture<>();
...

```

```
// is not important if the argument is set to true or false
cf.cancel(true/false);
...
cf.get(); // CancellationException
```

Explicitly complete a CompletableFuture

A `CompletableFuture` can be explicitly completed using `complete(T value)`, `completeAsync(Supplier<? extends T> supplier)`, and `completeAsync(Supplier<? extends T> supplier, Executor executor)`. `T` is the value returned by `get()`. Here it is a method that creates `CompletableFuture` and returns it immediately. Another thread is responsible for executing some tax computations and completing the `CompletableFuture` with the corresponding result:

```
public static CompletableFuture<Integer> taxes() {
    CompletableFuture<Integer> completableFuture
        = new CompletableFuture<>();

    new Thread(() -> {
        int result = new Random().nextInt(100);
        Thread.sleep(10);

        completableFuture.complete(result);
    }).start();

    return completableFuture;
}
```

And, let's call this method:

```
logger.info("Computing taxes ...");

CompletableFuture<Integer> cfTaxes = CustomerAsynccs.taxes();

while (!cfTaxes.isDone()) {
    logger.info("Still computing ...");
}

int result = cfTaxes.get();
logger.info(() -> "Result: " + result);
```

A possible output will be the following:

```
[14:09:40] [INFO ] Computing taxes ...
[14:09:40] [INFO ] Still computing ...
```

```
[14:09:40] [INFO ] Still computing ...  
...  
[14:09:40] [INFO ] Still computing ...  
[14:09:40] [INFO ] Result: 17
```

If we already know the result of `CompletableFuture`, then we can call `completedFuture(U value)` as in the following example:

```
CompletableFuture<String> completableFuture  
    = CompletableFuture.completedFuture("How are you?");  
  
String result = completableFuture.get();  
logger.info(() -> "Result: " + result); // Result: How are you?
```



Also, check the documentation of `whenComplete()` and `whenCompleteAsync()`.

217. Combining multiple `CompletableFuture` instances

In most cases, combining `CompletableFuture` instances can be accomplished using the following:

- `thenCompose()`
- `thenCombine()`
- `allOf()`
- `anyOf()`

By combining `CompletableFuture` instances, we can shape complex asynchronous solutions. This way, multiple `CompletableFuture` instances can combine their powers for reaching a common goal.

Combining via `thenCompose()`

Let's assume that we have the following two `CompletableFuture` instances in a helper class named `CustomerAsynccs`:

```
private static CompletableFuture<String>  
    fetchOrder(String customerId) {
```



```
        return CompletableFuture.supplyAsync(() -> {
            return "Order of " + customerId;
        });
    }

    private static CompletableFuture<Integer> computeTotal(String order) {

        return CompletableFuture.supplyAsync(() -> {
            return order.length() + new Random().nextInt(1000);
        });
    }
}
```

Now, we want to fetch the order of a certain customer, and, once the order is available, we want to compute the total of this order. This means that we need to call `fetchOrder()` and afterward `computeTotal()`. We can do this via `thenApply()`:

```
CompletableFuture<CompletableFuture<Integer>> cfTotal
    = fetchOrder(customerId).thenApply(o -> computeTotal(o));

int total = cfTotal.get().get();
```

Obviously, this is not a convenient solution since the result is of the `CompletableFuture<CompletableFuture<Integer>>` type. In order to avoid the nesting of `CompletableFuture` instances, we can rely on `thenCompose()` as follows:

```
CompletableFuture<Integer> cfTotal
    = fetchOrder(customerId).thenCompose(o -> computeTotal(o));

int total = cfTotal.get();

// e.g., Total: 734
logger.info(() -> "Total: " + total);
```



Whenever we need to obtain a flattened result from a chain of `CompletableFuture` instances, we can use `thenCompose()`. This way we avoid nested examples of `CompletableFuture` instances.

Further parallelization can be obtained using `thenComposeAsync()`.

Combining via thenCombine()

While `thenCompose()` is useful to chain two dependent `CompletableFuture` instances, `thenCombine()` is useful to chain two independent instances of `CompletableFuture`. When both `CompletableFuture` instances complete we can continue.

Let's assume that we have the following two `CompletableFuture` instances:

```
private static CompletableFuture<Integer> computeTotal(String order) {
    return CompletableFuture.supplyAsync(() -> {
        return order.length() + new Random().nextInt(1000);
    });
}

private static CompletableFuture<String> packProducts(String order) {
    return CompletableFuture.supplyAsync(() -> {
        return "Order: " + order
            + " | Product 1, Product 2, Product 3, ... ";
    });
}
```

In order to deliver a customer order, we need to compute the total (for emitting the invoice) and pack the ordered products. These two actions can be accomplished in parallel. In the end, we deliver the parcel containing the ordered products and the invoice. Achieving this via `thenCombine()` can be done as follows:

```
CompletableFuture<String> cfParcel = computeTotal(order)
    .thenCombine(packProducts(order), (total, products) -> {
        return "Parcel-[" + products + " Invoice: $" + total + "];"
    });

String parcel = cfParcel.get();

// e.g. Delivering: Parcel-[Order: #332 | Product 1, Product 2,
// Product 3, ... Invoice: $314]
logger.info(() -> "Delivering: " + parcel);
```

The callback function given to `thenCombine()` will be invoked after both `CompletableFuture` instances are complete.

If all we need is to do something when two `CompletableFuture` instances complete normally (this and another one) then we can rely on `thenAcceptBoth()`. This method returns a new `CompletableFuture` that is executed with the two results as arguments to the supplied action. The two results are this and the other given stage (they must complete normally). Here is an example:

```
CompletableFuture<Void> voidResult = CompletableFuture
    .supplyAsync(() -> "Pick")
    .thenAcceptBoth(CompletableFuture.supplyAsync(() -> " me"),
        (pick, me) -> System.out.println(pick + me));
```

If the results of these two `CompletableFuture` instances are not needed, then `runAfterBoth()` is much preferred.

Combining via `allOf()`

Let's assume that we want to download the following list of invoices:

```
List<String> invoices = Arrays.asList("#2334", "#122", "#55");
```

This can be seen as a bunch of independent tasks that can be accomplished in parallel, so we can do it using `CompletableFuture` as follows:

```
public static CompletableFuture<String>
    downloadInvoices(String invoice) {

    return CompletableFuture.supplyAsync(() -> {
        logger.info(() -> "Downloading invoice: " + invoice);

        return "Downloaded invoice: " + invoice;
    });
}

CompletableFuture<String> [] cfInvoices = invoices.stream()
    .map(CustomerAsyncs::downloadInvoices)
    .toArray(CompletableFuture[]::new);
```

At this point, we have an array of `CompletableFuture` instances, and, therefore, an array of asynchronous computations. Furthermore, we want to run all of them in parallel. This can be accomplished using the `allOf(CompletableFuture<?>... cfs)` method. The result consists of a `CompletableFuture<Void>` as follows:

```
CompletableFuture<Void> cfDownloaded
    = CompletableFuture.allOf(cfInvoices);
cfDownloaded.get();
```

Obviously, the result of `allOf()` is not very useful. What can we do with `CompletableFuture<Void>`? There are definitely many problems when we need the results of each computation involved in this parallelization, so we need a solution for fetching the results instead of relying on `CompletableFuture<Void>`.

We can solve this problem via `thenApply()` as follows:

```
List<String> results = cfDownloaded.thenApply(e -> {
    List<String> downloaded = new ArrayList<>();

    for (CompletableFuture<String> cfInvoice: cfInvoices) {
        downloaded.add(cfInvoice.join());
    }

    return downloaded;
}).get();
```



The `join()` method is similar to `get()`, but, if the underlying `CompletableFuture` completes exceptionally, it throws an unchecked exception.

Since we are calling `join()` after all the involved `CompletableFuture` have completed, there is no blocking point.

The returned `List<String>` contains the results obtained by calling the `downloadInvoices()` method as follows:

```
Downloaded invoice: #2334
Downloaded invoice: #122
Downloaded invoice: #55
```

Combining via `anyOf()`

Let's assume that we want to organize a raffle for our customers:

```
List<String> customers = Arrays.asList(
    "#1", "#4", "#2", "#7", "#6", "#5"
);
```

We can start to solve this problem by defining the following trivial method:

```
public static CompletableFuture<String> raffle(String customerId) {  
    return CompletableFuture.supplyAsync(() -> {  
        Thread.sleep(new Random().nextInt(5000));  
        return customerId;  
    });  
}
```

Now, we can create an array of `CompletableFuture<String>` instances, as follows:

```
CompletableFuture<String>[] cfCustomers = customers.stream()  
    .map(CustomerAsyncs::raffle)  
    .toArray(CompletableFuture[]::new);
```

To find the winner of the raffle, we want to run `cfCustomers` in parallel, and the first `CompletableFuture` that completes is the winner. Since the `raffle()` method blocks for a random number of seconds, the winner will be randomly chosen. We are not interested in the rest of the `CompletableFuture` instances, so they should be completed immediately after the winner has been chosen.

This is a job for `anyOf(CompletableFuture<?>... cfs)`. It returns a new `CompletableFuture` that is completed when any of the involved `CompletableFuture` instances completes. Let's see it at work:

```
CompletableFuture<Object> cfWinner  
    = CompletableFuture.anyOf(cfCustomers);  
  
Object winner = cfWinner.get();  
  
// e.g., Winner: #2  
logger.info(() -> "Winner: " + winner);
```



Pay attention to scenarios that rely on `CompletableFuture` that return results of different types. Since `anyOf()` returns `CompletableFuture<Object>`, it is difficult to know the `CompletableFuture` types that have completed first.

218. Optimizing busy waiting

The *busy waiting* technique (also known as *busy-looping* or *spinning*) consists of a loop that checks a condition (typically, a flag condition). For example, the following loop waits for a service to start:

```
private volatile boolean serviceAvailable;
...
while (!serviceAvailable) {}
```

Java 9 introduced the `Thread.onSpinWait()` method. This is a hotspot that gives the JVM a hint that the following code is in a spin loop:

```
while (!serviceAvailable) {
    Thread.onSpinWait();
}
```



Intel SSE2 PAUSE instruction is provided precisely for this reason. For more details, see the Intel official documentation. Also have a look at this link: <https://software.intel.com/en-us/articles/benefitting-power-and-performance-sleep-loops>.

If we add this while loop in a context, then we obtain the following class:

```
public class StartService implements Runnable {

    private volatile boolean serviceAvailable;

    @Override
    public void run() {
        System.out.println("Wait for service to be available ...");

        while (!serviceAvailable) {
            // Use a spin-wait hint (ask the processor to
            // optimize the resource)
            // This should perform better if the underlying
            // hardware supports the hint
            Thread.onSpinWait();
        }

        serviceRun();
    }

    public void serviceRun() {
        System.out.println("Service is running ...");
    }
}
```

```
    public void setServiceAvailable(boolean serviceAvailable) {
        this.serviceAvailable = serviceAvailable;
    }
}
```

And, we can easily test it (do not expect to see the effect of `onSpinWait()`):

```
StartService startService = new StartService();
new Thread(startService).start();

Thread.sleep(5000);

startService.setServiceAvailable(true);
```

219. Task Cancellation

Cancellation is a common technique used for forcibly stopping or completing a task that is currently running. A canceled task will not complete naturally. Cancellation should have no effect on an already completed task. Think of it as a **Cancel** button of a GUI.

Java doesn't provide a preemptive way for stopping a thread. Therefore for canceling a task, a common practice is to rely on a loop that uses a flag condition. The task responsibility is to check this flag periodically, and when it finds the flag set, then it should stop as fast as possible. The following code is an example of this:

```
public class RandomList implements Runnable {
    private volatile boolean cancelled;
    private final List<Integer> randoms = new CopyOnWriteArrayList<>();
    private final Random rnd = new Random();

    @Override
    public void run() {
        while (!cancelled) {
            randoms.add(rnd.nextInt(100));
        }
    }

    public void cancel() {
        cancelled = true;
    }

    public List<Integer> getRandoms() {
        return randoms;
    }
}
```

The focus here is on the `cancel`d variable. Notice that this variable was declared as `volatile` (also known as the lighter-weight synchronization mechanism). Being a `volatile` variable, it is not cached by threads and operations on it are not reordered in memory; therefore, a thread cannot see an old value. Any thread that reads a `volatile` field will see the most recently written value. This is exactly what we need in order to communicate the cancellation action to all running threads that are interested in this action. The following diagram depicts how `volatile` and non-`volatile` work:

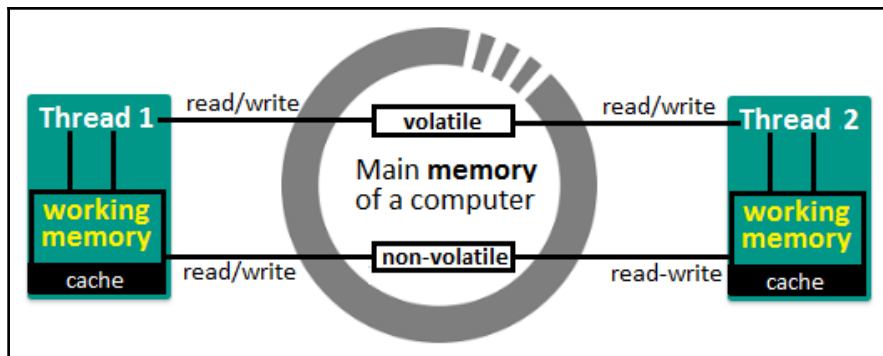

Notice that the `volatile` variables are not a good fit for read-modify-write scenarios. For such scenarios, we will rely on atomic variables (for example, `AtomicBoolean`, `AtomicInteger`, `AtomicReference`, and so on).

Now, let's provide a simple snippet of code for canceling the task implemented in `RandomList`:

```
RandomList rl = new RandomList();

ExecutorService executor = Executors.newFixedThreadPool(10);

for (int i = 0; i < 100; i++) {
    executor.execute(rl);
}

Thread.sleep(100);

rl.cancel();

System.out.println(rl.getRandoms());
```

220. ThreadLocal

Java threads share the same memory, but sometimes we need to have dedicated memory for each thread. Java provides `ThreadLocal` as an approach for storing and retrieving values for each thread separately. A single instance of `ThreadLocal` can store and retrieve values of multiple threads. If thread A stores the `x` value and thread B stores the `y` value in the same instance of `ThreadLocal` then, later on, thread A retrieves the `x` value and thread B retrieves the `y` value.

Java `ThreadLocal` is typically used in the following two scenarios:

- For providing per-thread instances (thread-safety and memory efficiency)
- For providing per-thread context

Let's take a look at problems for each scenario in the next sections.

Per-thread instances

Let's assume that we have a single-thread application that uses a global variable of the `StringBuilder` type. In order to transform the application in a multithreaded application, we have to deal with `StringBuilder`, which is not thread-safe. Basically, we have several approaches such as synchronization and `StringBuffer` or other approaches. However, we can use `ThreadLocal` as well. The main idea here is to provide a separate `StringBuilder` to each thread. Using `ThreadLocal`, we can do it as follows:

```
private static final ThreadLocal<StringBuilder>
    threadLocal = new ThreadLocal<>() {

    @Override
    protected StringBuilder initialValue() {
        return new StringBuilder("ThreadSafe ");
    }
};
```

The current thread's *initial value* for this thread-local variable is set via the `initialValue()` method. In Java 8, this can be re-written via `withInitial()` as follows:

```
private static final ThreadLocal<StringBuilder> threadLocal
    = ThreadLocal.<StringBuilder> withInitial(() -> {

    return new StringBuilder("Thread-safe ");
});
```

Working with `ThreadLocal` is done using `get()` and `set()`. Every call of `set()` stores the given value in a memory region that only the current thread has access to. Later on, calling `get()` will retrieve the value from this region. In addition, once the job is done, it is advisable to avoid memory leaks by calling the `remove()` or `set(null)` methods on the `ThreadLocal` instance.

Let's see a `ThreadLocal` at work using a `Runnable`:

```
public class ThreadSafeStringBuilder implements Runnable {

    private static final Logger logger =
        Logger.getLogger(ThreadSafeStringBuilder.class.getName());
    private static final Random rnd = new Random();

    private static final ThreadLocal<StringBuilder> threadLocal
        = ThreadLocal.<StringBuilder> withInitial(() -> {

        return new StringBuilder("Thread-safe ");
    });

    @Override
    public void run() {
        logger.info(() -> "-> " + Thread.currentThread().getName()
            + " [" + threadLocal.get() + "]");

        Thread.sleep(rnd.nextInt(2000));

        // threadLocal.set(new StringBuilder(
        // Thread.currentThread().getName()));
        threadLocal.get().append(Thread.currentThread().getName());

        logger.info(() -> "-> " + Thread.currentThread().getName()
            + " [" + threadLocal.get() + "]");

        threadLocal.set(null);
        // threadLocal.remove();
    }
}
```

```
        logger.info(() -> "-> " + Thread.currentThread().getName()
            + " [" + threadLocal.get() + "]");
    }
}
```

And, let's test it using several threads:

```
ThreadSafeStringBuilder threadSafe = new ThreadSafeStringBuilder();

for (int i = 0; i < 3; i++) {
    new Thread(threadSafe, "thread-" + i).start();
}
```

The output reveals that each thread accesses its own `StringBuilder`:

```
[14:26:39] [INFO] -> thread-1 [Thread-safe ]
[14:26:39] [INFO] -> thread-0 [Thread-safe ]
[14:26:39] [INFO] -> thread-2 [Thread-safe ]
[14:26:40] [INFO] -> thread-0 [Thread-safe thread-0]
[14:26:40] [INFO] -> thread-0 [null]
[14:26:41] [INFO] -> thread-1 [Thread-safe thread-1]
[14:26:41] [INFO] -> thread-1 [null]
[14:26:41] [INFO] -> thread-2 [Thread-safe thread-2]
[14:26:41] [INFO] -> thread-2 [null]
```



In scenarios such as the preceding one, `ExecutorService` can be used as well.

Here is another snippet of code that provides a JDBC Connection to each thread:

```
private static final ThreadLocal<Connection> connections
    = ThreadLocal.<Connection> withInitial(() -> {

    try {
        return DriverManager.getConnection("jdbc:mysql://...");
    } catch (SQLException ex) {
        throw new RuntimeException("Connection acquisition failed!", ex);
    }
});

public static Connection getConnection() {
    return connections.get();
}
```

Per-thread context

Let's assume that we have the following `Order` class:

```
public class Order {  
  
    private final int customerId;  
  
    public Order(int customerId) {  
        this.customerId = customerId;  
    }  
  
    // getter and toString() omitted for brevity  
}
```

And, we write `CustomerOrder` as follows:

```
public class CustomerOrder implements Runnable {  
  
    private static final Logger logger  
        = Logger.getLogger(CustomerOrder.class.getName());  
    private static final Random rnd = new Random();  
  
    private static final ThreadLocal<Order>  
        customerOrder = new ThreadLocal<>();  
  
    private final int customerId;  
  
    public CustomerOrder(int customerId) {  
        this.customerId = customerId;  
    }  
  
    @Override  
    public void run() {  
        logger.info(() -> "Given customer id: " + customerId  
            + " | " + customerOrder.get()  
            + " | " + Thread.currentThread().getName());  
  
        customerOrder.set(new Order(customerId));  
  
        try {  
            Thread.sleep(rnd.nextInt(2000));  
        } catch (InterruptedException ex) {  
            Thread.currentThread().interrupt();  
            logger.severe(() -> "Exception: " + ex);  
        }  
  
        logger.info(() -> "Given customer id: " + customerId
```

```
        + " | " + customerOrder.get ()
        + " | " + Thread.currentThread().getName ());

        customerOrder.remove ();
    }
}
```

For each `customerId`, we have a dedicated thread that we control:

```
CustomerOrder co1 = new CustomerOrder(1);
CustomerOrder co2 = new CustomerOrder(2);
CustomerOrder co3 = new CustomerOrder(3);

new Thread(co1).start ();
new Thread(co2).start ();
new Thread(co3).start ();
```

So, each thread modifies a certain instance of `CustomerOrder` (there is a particular thread for each instance).

The `run()` method fetches the order for the given `customerId` and stores it in the `ThreadLocal` variable, using the `set()` method.

A possible output will be as follows:

```
[14:48:20] [INFO]
    Given customer id: 3 | null | Thread-2
[14:48:20] [INFO]
    Given customer id: 2 | null | Thread-1
[14:48:20] [INFO]
    Given customer id: 1 | null | Thread-0

[14:48:20] [INFO]
    Given customer id: 2 | Order{customerId=2} | Thread-1
[14:48:21] [INFO]
    Given customer id: 3 | Order{customerId=3} | Thread-2
[14:48:21] [INFO]
    Given customer id: 1 | Order{customerId=1} | Thread-0
```

In scenarios like the preceding one, avoid using `ExecutorService`. There is no guarantee that each `Runnable` (of a given `customerId`) will be handled by the same thread at every execution. This may lead to weird results.

221. Atomic variables

A naive approach for counting all numbers from 1 to 1,000,000 via `Runnable` may look as follows:

```
public class Incrementator implements Runnable {

    public [static] int count = 0;

    @Override
    public void run() {
        count++;
    }

    public int getCount() {
        return count;
    }
}
```

And, let's spin-up five threads that will increment the `count` variable concurrently:

```
Incrementator nonAtomicInc = new Incrementator();
ExecutorService executor = Executors.newFixedThreadPool(5);

for (int i = 0; i < 1_000_000; i++) {
    executor.execute(nonAtomicInc);
}
```

But, if we run this code several times, we get different results as follows:

```
997776, 997122, 997681 ...
```

So, why don't we get the expected result, 1,000,000? The reason is because `count++` is not an atomic operation/action. It consists of three atomic bytecode instructions:

```
iload_1
iinc 1, 1
istore_1
```

During one thread, read the `count` value and increment it by one, and another thread reads the older value leading to a wrong result. In a multi-threading application, the scheduler can halt the execution of the current thread between each of these bytecode instructions and start a new thread, which works on the same variable. We can fix things via synchronization or, even better, via atomic variables.

Atomic variable classes are available in `java.util.concurrent.atomic`. They are wrapper classes that limit the scope of contention to a single variable; they are much more lightweight than Java synchronization and are based on **CAS** (short for **Compare and Swap**: modern CPUs support this technique in which it compares the content of a given memory location with a given value and updates it to a new value if the current value equals the expected value). Mainly, these are atomic compound actions that affect a single value in a lock-free manner similar to `volatile`. The most used atomic variables are the scalars:

- `AtomicInteger`
- `AtomicLong`
- `AtomicBoolean`
- `AtomicReference`

And, the following are for arrays:

- `AtomicIntegerArray`
- `AtomicLongArray`
- `AtomicReferenceArray`

Let's rewrite our example via `AtomicInteger`:

```
public class AtomicIncrementator implements Runnable {  
  
    public static AtomicInteger count = new AtomicInteger();  
  
    @Override  
    public void run() {  
        count.incrementAndGet();  
    }  
  
    public int getCount() {  
        return count.get();  
    }  
}
```

Notice that, instead of `count++`, we wrote `count.incrementAndGet()`. This is just one of the methods provided by `AtomicInteger`. This method atomically increments the variable and returns the new value. This time, the `count` will be 1,000,000.

The following table contains several methods of `AtomicInteger` that are commonly used. The left column contains the methods, while the right column contains the non-atomic meaning:

```
AtomicInteger ai = new AtomicInteger(0); // atomic
int i = 0; // non-atomic

// and
int q = 5;
int r;

// and
int e = 0;
boolean b;
```

Atomic operation	Non-atomic counterpart
<code>r = ai.get();</code>	<code>r = i;</code>
<code>ai.set(q);</code>	<code>i = q;</code>
<code>r = ai.incrementAndGet();</code>	<code>r = ++i;</code>
<code>r = ai.getAndIncrement();</code>	<code>r = i++;</code>
<code>r = ai.decrementAndGet();</code>	<code>r = --i;</code>
<code>r = ai.getAndDecrement();</code>	<code>r = i--;</code>
<code>r = ai.addAndGet(q);</code>	<code>i = i + q; r = i;</code>
<code>r = ai.getAndAdd(q);</code>	<code>r = i; i = i + q;</code>
<code>r = ai.getAndSet(q);</code>	<code>r = i; i = q;</code>
<code>b = ai.compareAndSet(e, q);</code>	<code>if (i == e) { i = q; return true; } else { return false; }</code>

Let's tackle several problems via atomic operations:

- Update the elements of an array via `updateAndGet (IntUnaryOperator updateFunction)`:

```
// [9, 16, 4, 25]
AtomicIntegerArray atomicArray
    = new AtomicIntegerArray(new int[] {3, 4, 2, 5});

for (int i = 0; i < atomicArray.length(); i++) {
    atomicArray.updateAndGet(i, elem -> elem * elem);
}
```

- Update a single integer via `updateAndGet (IntUnaryOperator updateFunction)`:

```
// 15
AtomicInteger nr = new AtomicInteger(3);
int result = nr.updateAndGet(x -> 5 * x);
```

- Update a single integer via `accumulateAndGet (int x, IntBinaryOperator accumulatorFunction)`:

```
// 15
AtomicInteger nr = new AtomicInteger(3);
// x = 3, y = 5
int result = nr.accumulateAndGet(5, (x, y) -> x * y);
```

- Update a single integer via `addAndGet (int delta)`:

```
// 7
AtomicInteger nr = new AtomicInteger(3);
int result = nr.addAndGet(4);
```

- Update a single integer via `compareAndSet (int expectedValue, int newValue)`:

```
// 5, true
AtomicInteger nr = new AtomicInteger(3);
boolean wasSet = nr.compareAndSet(3, 5);
```

Starting with JDK 9, atomic variable classes have been enriched with several methods such as `get/setPlain()`, `get/setOpaque()`, `getAcquire()`, and their companions. To gain an understanding of these methods, have a look at *Using JDK 9 Memory Order Modes* by Doug Lea, available at <http://gee.cs.oswego.edu/dl/html/j9mm.html>, at the time of writing.

Adders and accumulators

Following the Java API documentation, in cases of multithreading applications that update frequently but read less frequently, it is recommended to rely on `LongAdder`, `DoubleAdder`, `LongAccumulator`, and `DoubleAccumulator`, instead of the `AtomicFoo` classes. For such scenarios, these classes are designed to optimize the usage of threads.

This means that, instead of using `AtomicInteger` for counting the integers from 1 to 1,000,000, we can use `LongAdder` as follows:

```
public class AtomicAdder implements Runnable {  
  
    public static LongAdder count = new LongAdder();  
  
    @Override  
    public void run() {  
  
        count.add(1);  
    }  
  
    public long getCount() {  
  
        return count.sum();  
    }  
}
```

Alternatively, we can use `LongAccumulator` as follows:

```
public class AtomicAccumulator implements Runnable {  
  
    public static LongAccumulator count  
        = new LongAccumulator(Long::sum, 0);  
  
    @Override  
    public void run() {  
  
        count.accumulate(1);  
    }  
  
    public long getCount() {  
  
        return count.get();  
    }  
}
```

The `LongAdder` and `DoubleAdder` are right for scenarios that imply additions (operations specific to additions), while `LongAccumulator` and `DoubleAccumulator` are right for scenarios that rely on a given function to combine values.

222. ReentrantLock

The `Lock` interface contains a set of locking operations that can be explicitly used to fine-tune the locking process (it provides more control than intrinsic locking). Among them, we have polled, unconditional, timed, and interruptible lock acquisition. Basically, `Lock` exposes the futures of the `synchronized` keyword with additional capabilities. The `Lock` interface is shown in the following code:

```
public interface Lock {
    void lock();
    void lockInterruptibly() throws InterruptedException;
    boolean tryLock();
    boolean tryLock(long timeout, TimeUnit unit)
        throws InterruptedException;
    void unlock();
    Condition newCondition();
}
```

One of the implementations of `Lock` is `ReentrantLock`. A *reentrant* lock acts as follows: when the thread enters for the first time into the lock, a hold count is set to one. Before unlocking, the thread can re-enter the lock causing the hold count to be incremented by one for each entry. Each unlock request decrements the hold count by one, and, when the hold count is zero, the locked resource is opened.

Having the same coordinates as the `synchronized` keyword, `ReentrantLock` follows the following idiom of implementation:

```
Lock / ReentrantLock lock = new ReentrantLock();
...
lock.lock();

try {
    ...
} finally {
    lock.unlock();
}
```



In the case of non-fair locks, the order in which threads are granted access is unspecified. If the lock should be fair (give precedence to the thread that has been waiting for the longest) then use the `ReentrantLock(boolean fair)` constructor.

Summing up integers from 1 to 1,000,000 via `ReentrantLock` can be accomplished as follows:

```
public class CounterWithLock {  
  
    private static final Lock lock = new ReentrantLock();  
  
    private static int count;  
  
    public void counter() {  
        lock.lock();  
  
        try {  
            count++;  
        } finally {  
            lock.unlock();  
        }  
    }  
}
```

And, let's use it via several threads:

```
CounterWithLock counterWithLock = new CounterWithLock();  
Runnable task = () -> {  
    counterWithLock.counter();  
};  
  
ExecutorService executor = Executors.newFixedThreadPool(8);  
for (int i = 0; i < 1_000_000; i++) {  
    executor.execute(task);  
}
```

Done!

As a bonus, the following code represents an idiom for resolving problems based on `ReentrantLock.lockInterruptibly()`. The code bundled to this book comes with an example of using `lockInterruptibly()`:

```
Lock / ReentrantLock lock = new ReentrantLock();  
public void execute() throws InterruptedException {  
    lock.lockInterruptibly();  
  
    try {  
        // do something  
    } finally {  
        lock.unlock();  
    }  
}
```

If the thread holding this lock is interrupted then `InterruptedException` is thrown. Using `lock()` instead of `lockInterruptibly()` will not be receptive to interruption.

In addition, the following code represents an idiom for using `ReentrantLock.tryLock(long timeout, TimeUnit unit)` throws `InterruptedException`. The code bundled to this book comes with an example as well:

```
Lock / ReentrantLock lock = new ReentrantLock();

public boolean execute() throws InterruptedException {

    if (!lock.tryLock(n, TimeUnit.SECONDS)) {
        return false;
    }

    try {
        // do something
    } finally {
        lock.unlock();
    }

    return true;
}
```

Note that `tryLock()` tries to acquire the lock for the specified time. If this time elapses, then the thread will not acquire the lock. It doesn't retry automatically. If the thread is interrupted during attempting to acquire the lock, then `InterruptedException` will be thrown.

Finally, the code bundled to this book comes with an example of using `ReentrantLock.newCondition()`. The idiom is in the next screenshot:

```

newCondition
Lock/ReentrantLock lock = new ReentrantLock();
Condition condition = lock.newCondition();
public void execute() throws InterruptedException {
    lock.lock();
    try {
        ...
        while/if(some_condition) {
            condition.await();
        }
    } finally {
        lock.unlock();
    }
}
lock.lock();
try {
    condition.signal(All)();
} finally {
    lock.unlock();
}

```

When await() is called the thread releases the lock. After getting the signal to continue the thread must acquire the lock again.

223. ReentrantReadWriteLock

Typically, a read-write tandem (for example, read-write a file) should be accomplished based on two statements:

- Readers can read simultaneously as long as there are no writers (shared pessimistic lock).
- A single writer can write at a time (exclusive/pessimistic locking).

The following diagram depicts readers on the left-hand side and writers on the right-hand side:

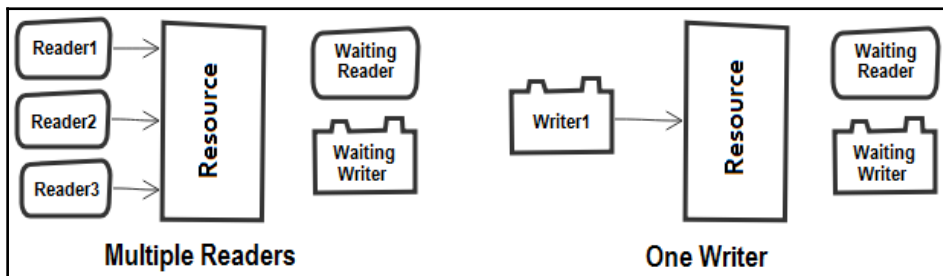

Mainly, the following behavior is implemented by `ReentrantReadWriteLock`:

- Provides pessimistic locking semantics for both locks (read and write lock).
- If some readers hold the read lock and a writer wants the write lock, then no more readers are allowed to acquire the read lock until the writer released the write lock.
- A writer can acquire the read lock, but a reader cannot acquire the write lock.



In case of non-fair locks, the order in which threads are granted access is unspecified. If the lock should be fair (give precedence to the thread that has been waiting for the longest), then use the `ReentrantReadWriteLock(boolean fair)` constructor.

The idiom for using `ReentrantReadWriteLock` is shown as follows:

```
ReadWriteLock / ReentrantReadWriteLock lock
    = new ReentrantReadWriteLock();
...
lock.readLock() / writeLock().lock();
try {
    ...
} finally {
    lock.readLock() / writeLock().unlock();
}
```

The following code represents a `ReentrantReadWriteLock` usage case that reads and writes an integer amount variable:

```
public class ReadWriteWithLock {

    private static final Logger logger
        = Logger.getLogger(ReadWriteWithLock.class.getName());
    private static final Random rnd = new Random();

    private static final ReentrantReadWriteLock lock
        = new ReentrantReadWriteLock(true);

    private static final Reader reader = new Reader();
    private static final Writer writer = new Writer();

    private static int amount;
```

```
private static class Reader implements Runnable {

    @Override
    public void run() {
        if (lock.isWriteLocked()) {
            logger.warning(() -> Thread.currentThread().getName()
                + " reports that the lock is hold by a writer ...");
        }

        lock.readLock().lock();

        try {
            logger.info(() -> "Read amount: " + amount
                + " by " + Thread.currentThread().getName());
        } finally {
            lock.readLock().unlock();
        }
    }
}

private static class Writer implements Runnable {

    @Override
    public void run() {
        lock.writeLock().lock();
        try {
            Thread.sleep(rnd.nextInt(2000));
            logger.info(() -> "Increase amount with 10 by "
                + Thread.currentThread().getName());

            amount += 10;
        } catch (InterruptedException ex) {
            Thread.currentThread().interrupt();
            logger.severe(() -> "Exception: " + ex);
        } finally {
            lock.writeLock().unlock();
        }
    }
    ...
}
```

And, let's perform 10 reads and 10 writes with two readers and four writers:

```
ExecutorService readerService = Executors.newFixedThreadPool(2);
ExecutorService writerService = Executors.newFixedThreadPool(4);

for (int i = 0; i < 10; i++) {
    readerService.execute(reader);
```



```
writerService.execute(writer);
}
```

A possible output will be as follows:

```
[09:09:25] [INFO] Read amount: 0 by pool-1-thread-1
[09:09:25] [INFO] Read amount: 0 by pool-1-thread-2
[09:09:26] [INFO] Increase amount with 10 by pool-2-thread-1
[09:09:27] [INFO] Increase amount with 10 by pool-2-thread-2
[09:09:28] [INFO] Increase amount with 10 by pool-2-thread-4
[09:09:29] [INFO] Increase amount with 10 by pool-2-thread-3
[09:09:29] [INFO] Read amount: 40 by pool-1-thread-2
[09:09:29] [INFO] Read amount: 40 by pool-1-thread-1
[09:09:31] [INFO] Increase amount with 10 by pool-2-thread-1
...
```



Before deciding to rely on `ReentrantReadWriteLock`, please consider that it may suffer from starvation (for example, when writers are given priority, readers might be starved). Moreover, we could not upgrade a read lock to a write lock (downgrading from writer to reader is possible), and there is no support for optimistic reads. If any of this matters for you then consider `StampedLock`, which we will look at in the next problem.

224. StampedLock

In a nutshell, `StampedLock` performs better than `ReentrantReadWriteLock` and supports optimistic reads. It is not like *reentrant*; therefore, it is prone to deadlocks. Mainly, a lock acquisition returns a stamp (a `long` value) that it is used in the `finally` block for unlocking. Each attempt to acquire a lock results in a new stamp, and, if no lock is available, then it may block until available. In other words, if the current thread is holding the lock, and attempts to acquire the lock again, it may cause a deadlock.

The `StampedLock` read/write orchestration process is achieved via several methods as follows:

- `readLock()`: Non-exclusively acquires the lock, blocking if necessary, until available. For a non-blocking attempt of acquiring the read lock, we have to `tryReadLock()`. For timeout blocking, we have `tryReadLock(long time, TimeUnit unit)`. The returned stamp is used in `unlockRead()`.

- `writeLock()`: Exclusively acquires the lock, blocking if necessary until available. For a non-blocking attempt to acquire the write lock, we have `tryWriteLock()`. For timeout blocking, we have `tryWriteLock(long time, TimeUnit unit)`. The returned stamp is used in `unlockWrite()`.
- `tryOptimisticRead()`: This is the method that adds a big plus to `StampedLock`. This method returns a stamp that should be validated via the `validate()` flag method. If the lock is not currently held in write mode, then the returned stamp is non-zero only.

The idioms for `readLock()` and `writeLock()` are pretty straightforward:

```
StampedLock lock = new StampedLock();
...
long stamp = lock.readLock() / writeLock();

try {
    ...
} finally {
    lock.unlockRead(stamp) / unlockWrite(stamp);
}
```

An attempt to give an idiom for `tryOptimisticRead()` can result in the following:

```
StampedLock lock = new StampedLock();

int x; // a writer-thread can modify x
...
long stamp = lock.tryOptimisticRead();
int thex = x;

if (!lock.validate(stamp)) {
    stamp = lock.readLock();

    try {
        thex = x;
    } finally {
        lock.unlockRead(stamp);
    }
}

return thex;
```

In this idiom, notice that the initial value (x) is assigned to the `theX` variable after getting the optimistic read lock. Then the `validate()` flag method is used to validate that the stamped lock has not been exclusively acquired since the emittance of the given stamp. If `validate()` returns `false` (equivalent with the fact that the write lock is acquired by a thread after the optimistic lock is acquired), then the read lock is acquired via the blocking `readLock()` and the value (x) is assigned again. Keep in mind that, if there is any write lock, the read lock may block. Acquiring the optimistic lock allows us to read the value(s) and then verify if there is any change in these value(s). Only if there is, will we have to go through the blocking read lock.

The following code represents a `StampedLock` usage case that reads and writes an integer amount variable. Basically, we reiterate the solution from the previous problem via optimistic reads:

```
public class ReadWriteWithStampedLock {

    private static final Logger logger
        = Logger.getLogger(ReadWriteWithStampedLock.class.getName());
    private static final Random rnd = new Random();

    private static final StampedLock lock = new StampedLock();

    private static final OptimisticReader optimisticReader
        = new OptimisticReader();
    private static final Writer writer = new Writer();

    private static int amount;

    private static class OptimisticReader implements Runnable {

        @Override
        public void run() {
            long stamp = lock.tryOptimisticRead();

            // if the stamp for tryOptimisticRead() is not valid
            // then the thread attempts to acquire a read lock
            if (!lock.validate(stamp)) {
                stamp = lock.readLock();
                try {
                    logger.info(() -> "Read amount (read lock): " + amount
                        + " by " + Thread.currentThread().getName());
                } finally {
                    lock.unlockRead(stamp);
                }
            } else {
                logger.info(() -> "Read amount (optimistic read): " + amount
```

```

        + " by " + Thread.currentThread().getName());
    }
}

private static class Writer implements Runnable {

    @Override
    public void run() {

        long stamp = lock.writeLock();

        try {
            Thread.sleep(rnd.nextInt(2000));
            logger.info(() -> "Increase amount with 10 by "
                + Thread.currentThread().getName());

            amount += 10;
        } catch (InterruptedException ex) {
            Thread.currentThread().interrupt();
            logger.severe(() -> "Exception: " + ex);
        } finally {
            lock.unlockWrite(stamp);
        }
    }
}
...
}

```

And, let's perform 10 reads and 10 writes with two readers and four writers:

```

ExecutorService readerService = Executors.newFixedThreadPool(2);
ExecutorService writerService = Executors.newFixedThreadPool(4);

for (int i = 0; i < 10; i++) {
    readerService.execute(optimisticReader);
    writerService.execute(writer);
}

```

A possible output will be the following:

```

...
[12:12:07] [INFO] Increase amount with 10 by pool-2-thread-4
[12:12:07] [INFO] Read amount (read lock): 90 by pool-1-thread-2
[12:12:07] [INFO] Read amount (optimistic read): 90 by pool-1-thread-2
[12:12:07] [INFO] Increase amount with 10 by pool-2-thread-1
...

```

Starting with JDK 10, we can query the type of a stamp using `isWriteLockStamp()`, `isReadLockStamp()`, `isLockStamp()`, and `isOptimisticReadStamp()`. Based on the type, we can decide the proper unlock method, for example, as follows:

```
if (StampedLock.isReadLockStamp(stamp))
    lock.unlockRead(stamp);
}
```

In the code bundled to this book, there is also an application for exemplifying the `tryConvertToWriteLock()` method. In addition, you may be interested in developing applications that use `tryConvertToReadLock()` and `tryConvertToOptimisticRead()`.

225. Deadlock (dining philosophers)

What is deadlock? A famous joke on the internet explains it as follows:

Interviewer: Explain to us deadlock and we'll hire you!

Me: Hire me and I'll explain it to you ...

A simple deadlock can be explained as an **A** thread holding the **L** lock and trying to acquire the **P** lock, and, at the same time, there is a **B** thread holding the **P** lock and trying to acquire the **L** lock. This kind of deadlock is known as **circular wait**. Java doesn't have a deadlock detection and resolving mechanism (as databases have), and so a deadlock can be very embarrassing for the application. A deadlock can completely or partially block the application, can cause serious performance penalties, weird behaviors, and so on. Typically, deadlocks are hard to debug, and the only way to solve a deadlock consists of restarting the application and hoping for the best.

The dining philosophers is a famous problem used for illustrating a deadlock. This problem says that five philosophers are sitting around a table. Each of them alternates thinking and eating. In order to eat, a philosopher needs two forks in his hands—the fork from his left-hand side and the fork from his right-hand side. The difficulty is imposed by the fact that there are only five forks. After eating, the philosopher puts both forks back on the table, and they can then be picked up by another philosopher who repeats the same cycle. When a philosopher is not eating, he/she is thinking. The following diagram illustrates this scenario:

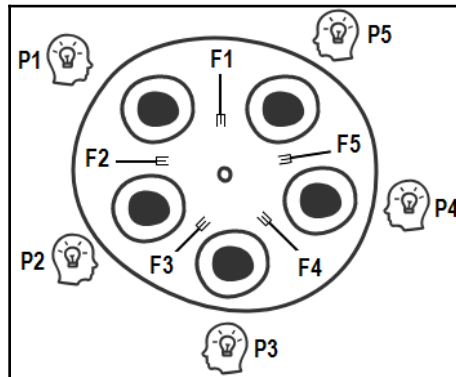

The main task is to find a solution to this problem that allows the philosophers to think and eat in such a way so as to avoid being starved to death.

In the code, we can consider each philosopher as a `Runnable` instance. Being `Runnable` instances, we can execute them in separate threads. Each philosopher can pick up two forks placed to his left and right. If we represent a fork as a `String`, then we can use the following code:

```
public class Philosopher implements Runnable {

    private final String leftFork;
    private final String rightFork;

    public Philosopher(String leftFork, String rightFork) {
        this.leftFork = leftFork;
        this.rightFork = rightFork;
    }

    @Override
    public void run() {
        // implemented below
    }
}
```

So, a philosopher can pick up `leftFork` and `rightFork`. But since the philosophers share these forks, a philosopher must acquire exclusive locks on these two forks. Having an exclusive lock on `leftFork` and an exclusive lock on `rightFork` is equivalent to having two forks in his hands. Having exclusive locks on `leftFork` and `rightFork` is equivalent to the philosopher eating. Releasing both exclusive locks is equivalent to the philosopher not eating and thinking.

Locking can be achieved via the `synchronized` keyword as in the following `run()` method:

```
@Override
public void run() {

    while (true) {
        logger.info(() -> Thread.currentThread().getName()
            + ": thinking");
        doIt();

        synchronized(leftFork) {
            logger.info(() -> Thread.currentThread().getName()
                + ": took the left fork (" + leftFork + ")");
            doIt();

            synchronized(rightFork) {
                logger.info(() -> Thread.currentThread().getName()
                    + ": took the right fork (" + rightFork + ") and eating");
                doIt();

                logger.info(() -> Thread.currentThread().getName()
                    + ": put the right fork ( " + rightFork
                    + ") on the table");
                doIt();
            }

            logger.info(() -> Thread.currentThread().getName()
                + ": put the left fork (" + leftFork
                + ") on the table and thinking");
            doIt();
        }
    }
}
```

A philosopher starts by thinking. After a while he is hungry, so he tries to pick up the left and right forks. If successful he will eat for a while. Afterwards, he put the forks on the table and continues to think until he is hungry again. Meanwhile, another philosopher will eat.

The `doIt()` method simulates the involved actions (thinking, eating, picking, and putting back the forks) via a random sleep. This can be seen in the code as follows:

```
private static void doIt() {
    try {
        Thread.sleep(rnd.nextInt(2000));
    } catch (InterruptedException ex) {
```

```
        Thread.currentThread().interrupt();
        logger.severe(() -> "Exception: " + ex);
    }
}
```

Finally, we need forks and the philosophers, see the following code:

```
String[] forks = {
    "Fork-1", "Fork-2", "Fork-3", "Fork-4", "Fork-5"
};

Philosopher[] philosophers = {
    new Philosopher(forks[0], forks[1]),
    new Philosopher(forks[1], forks[2]),
    new Philosopher(forks[2], forks[3]),
    new Philosopher(forks[3], forks[4]),
    new Philosopher(forks[4], forks[0])
};
```

Each philosopher will run in a thread, as follows:

```
Thread threadPhilosopher1
    = new Thread(philosophers[0], "Philosopher-1");
...
Thread threadPhilosopher5
    = new Thread(philosophers[4], "Philosopher-5");

threadPhilosopher1.start();
...
threadPhilosopher5.start();
```

This implementation seems to be OK and may even work fine for a while. However, sooner or later this implementation blocks with output as follows:

```
[17:29:21] [INFO] Philosopher-5: took the left fork (Fork-5)
...
// nothing happens
```

This is a deadlock! Each philosopher has his left fork in hand (exclusive lock on it) and waits for the right fork to be on the table (the lock is to be released). Obviously, this expectation cannot be satisfied, since there are only five forks and each philosopher has one in his hands.

In order to avoid this deadlock, there is a pretty simple solution. We just force one of the philosophers to pick up the right fork first. After successfully picking the right fork, he can try to pick the left one. In the code, this is a quick modification to the following line:

```
// the original line
new Philosopher(forks[4], forks[0])

// the modified line that eliminates the deadlock
new Philosopher(forks[0], forks[4])
```

This time we can run the application without deadlocks.

Summary

Well, that's all! This chapter covered problems about the fork/join framework, `CompletableFuture`, `ReentrantLock`, `ReentrantReadWriteLock`, `StampedLock`, atomic variables, tasks cancellation, interruptible methods, thread-local, and deadlocks.

Download the applications from this chapter to see the results and to see additional details.

12

Optional

This chapter includes 24 problems meant to draw your attention to several rules for working with `Optional`. The problems and solutions presented in this section are based on the Java language architect Brian Goetz's definition:

"Optional is intended to provide a limited mechanism for library method return types where there needed to be a clear way to represent no result, and using null for such was overwhelmingly likely to cause errors."

But where there are rules, there are exceptions as well. Therefore, do not conclude that the rules (or practices) presented here should be followed (or avoided) at all costs. As always, it depends on the problem, and you have to evaluate the situation, weighing up the pros and cons.

You may also like to check the CDI plugin (<https://github.com/Pscheidl/ForEE>) for Java EE (Jakarta EE) developed by Pavel Pscheidl. This is a Jakarta EE/Java EE fault-tolerance guard leveraging the `Optional` pattern. Its power lies in its simplicity.

Problems

Use the following problems to test your `Optional` programming prowess. I strongly encourage you to give each problem a try before you turn to the solutions and download the example programs:

226. **Initializing `Optional`:** Write a program that exemplifies the right and wrong approaches for initializing `Optional`.
227. **`Optional.get()` and missing value:** Write a program that exemplifies the right and wrong usage of `Optional.get()`.

228. **Returning an already-constructed default value:** Write a program that, when no value is present, sets (or returns) an already-constructed default value via the `Optional.orElse()` method.
229. **Returning a non-existent default value:** Write a program that, when no value is present, sets (or returns) a non-existent default value via the `Optional.orElseGet()` method.
230. **Throwing `NoSuchElementException`:** Write a program that, when no value is present, throws an exception of the `NoSuchElementException` type or another exception.
231. **The `Optional` and `null` references:** Write a program that exemplifies the correct usage of `Optional.orElse(null)`.
232. **Consuming a present `Optional` class:** Write a program that consumes a present `Optional` class via `ifPresent()` and via `ifPresentElse()`.
233. **Returning a present `Optional` class or another one:** Let's assume that we have `Optional`. Write a program that relies on `Optional.or()` for returning this `Optional` (if its value is present) or another `Optional` class (if its value is not present).
234. **Chaining lambdas via `orElseFoo()`:** Write a program that exemplifies the usage of `orElse()` and `orElseFoo()` for avoiding disrupting lambda chains.
235. **Do not use `Optional` just for getting a value:** Exemplify the bad practice of chaining the `Optional` methods with the single purpose of getting some values.
236. **Do not use `Optional` for fields:** Exemplify the bad practice of declaring fields of the `Optional` type.
237. **Do not use `Optional` in constructor args:** Exemplify the bad practice of using `Optional` in constructors arguments.
238. **Do not use `Optional` in setters args:** Exemplify the bad practice of using `Optional` in setter arguments.
239. **Do not use `Optional` in methods args:** Exemplify the bad practice of using `Optional` in method arguments.
240. **Do not use `Optional` to return empty or `null` collections or arrays:** Exemplify the bad practice of using `Optional` for returning the empty/null collections or arrays.

241. **Avoiding `Optional` in collections:** Using `Optional` in collections can be a design smell. Exemplify a typical use case and possible alternatives for avoiding `Optional` in collections.
242. **Confusing `of()` with `ofNullable()`:** Exemplify the potential consequences of confusing `Optional.of()` with `ofNullable()`.
243. **`Optional<T>` versus `OptionalInt`:** Exemplify the usage of non-generic `OptionalInt` instead of `Optional<T>`.
244. **Asserting equality of `Optional` classes:** Exemplify asserting the equality of `Optional` classes.
245. **Transforming values via `map()` and `flatMap()`:** Write several snippets of code for exemplifying the usage of `Optional.map()` and `flatMap()`.
246. **Filter values via `Optional.filter()`:** Exemplify the usage of `Optional.filter()` for rejecting wrapped values based on a predefined rule.
247. **Chaining the `Optional` and `Stream` APIs:** Exemplify the usage of `Optional.stream()` for chaining the `Optional` API with the `Stream` API.
248. **`Optional` and identity-sensitive operations:** Write a snippet of code that sustains the fact that *identity-sensitive* operations should be avoided in the case of `Optional`.
249. **Return `boolean` if `Optional` is empty:** Write two snippets of code for exemplifying two solutions for returning `boolean` if the given `Optional` class is empty.

Solutions

The following sections describe solutions to the preceding problems. Remember that there usually isn't a single correct way to solve a particular problem. Also, remember that the explanations shown here include only the most interesting and important details needed to solve the problems. Download the example solutions to see additional details and to experiment with the programs at <https://github.com/PacktPublishing/Java-Coding-Problems>.

226. Initializing Optional

Initializing `Optional` should be done via `Optional.empty()` instead of `null`:

```
// Avoid
Optional<Book> book = null;

// Prefer
Optional<Book> book = Optional.empty();
```

Since `Optional` acts as a container (box), it is meaningless to initialize it with `null`.

227. `Optional.get()` and missing value

So, if we have decided to call `Optional.get()` to fetch the value wrapped in `Optional`, then we shouldn't do it as follows:

```
Optional<Book> book = ...; // this is prone to be empty

// Avoid
// if "book" is empty then the following code will
// throw a java.util.NoSuchElementException
Book theBook = book.get();
```

In other words, before fetching the value via `Optional.get()`, we need to prove that the value is present. A solution consists of calling `isPresent()` before calling `get()`. This way, we add a check that allows us to handle the missing value case:

```
Optional<Book> book = ...; // this is prone to be empty

// Prefer
if (book.isPresent()) {
    Book theBook = book.get();
    ... // do something with "theBook"
} else {
    ... // do something that does not call book.get()
}
```



Nevertheless, keep in mind that the `isPresent()-get()` team has a bad reputation, and so use it with caution. Consider checking the next problems, which provide alternatives to this team. Moreover, at some point, `Optional.get()` is likely to be deprecated.

228. Returning an already-constructed default value

Let's assume that we have a method that returns a result based on `Optional`. If `Optional` is empty then the method returns a default value. If we consider the previous problem, then a possible solution can be written as follows:

```
public static final String BOOK_STATUS = "UNKNOWN";
...
// Avoid
public String findStatus() {
    Optional<String> status = ...; // this is prone to be empty

    if (status.isPresent()) {
        return status.get();
    } else {
        return BOOK_STATUS;
    }
}
```

Well, this is not a bad solution, but is not very elegant. A more concise and elegant solution will rely on the `Optional.orElse()` method. This method is useful for replacing the `isPresent()-get()` pair when we want to set or return a default value in case of an empty `Optional` class. The preceding snippet of code can be rewritten as follows:

```
public static final String BOOK_STATUS = "UNKNOWN";
...
// Prefer
public String findStatus() {
    Optional<String> status = ...; // this is prone to be empty

    return status.orElse(BOOK_STATUS);
}
```



But keep in mind that `orElse()` is evaluated even when the `Optional` class involved is not empty. In other words, `orElse()` is evaluated even if its value is not used. Having said that, it is advisable to rely on `orElse()` only when its argument is an already-constructed value. That way, we mitigate a potential performance penalty. The next problem addresses the case when `orElse()` is not the correct choice.

229. Returning a non-existent default value

Let's assume that we have a method that returns a result based on an `Optional` class. If this `Optional` class is empty then the method returns a computed value. The `computeStatus()` method computes this value:

```
private String computeStatus() {
    // some code used to compute status
}
```

Now, a clumsy solution will rely on the `isPresent()`-`get()` pair, as follows:

```
// Avoid
public String findStatus() {
    Optional<String> status = ...; // this is prone to be empty

    if (status.isPresent()) {
        return status.get();
    } else {
        return computeStatus();
    }
}
```

Even if this solution is clumsy, it is still better than relying on the `orElse()` method, as follows:

```
// Avoid
public String findStatus() {
    Optional<String> status = ...; // this is prone to be empty

    // computeStatus() is called even if "status" is not empty
    return status.orElse(computeStatus());
}
```

In this case, the preferred solution relies on the `Optional.orElseGet()` method. The argument of this method is `Supplier`, and so it is executed only when the `Optional` value is not present. This is much better than `orElse()` since it saves us from executing extra code that shouldn't be executed when the `Optional` value is present. So, the preferred solution is as follows:

```
// Prefer
public String findStatus() {
    Optional<String> status = ...; // this is prone to be empty

    // computeStatus() is called only if "status" is empty
    return status.orElseGet(this::computeStatus);
}
```

230. Throwing NoSuchElementException

Sometimes, if `Optional` is empty, we want to throw an exception (for example, `NoSuchElementException`). The clumsy solution to this problem is listed as follows:

```
// Avoid
public String findStatus() {

    Optional<String> status = ...; // this is prone to be empty

    if (status.isPresent()) {
        return status.get();
    } else {
        throw new NoSuchElementException("Status cannot be found");
    }
}
```

But a much more elegant solution will rely on the `Optional.orElseThrow()` method. The signature of this method, `orElseThrow(Supplier<? extends X> exceptionSupplier)`, allows us to give the exception as follows (if the value is present then `orElseThrow()` will return it):

```
// Prefer
public String findStatus() {

    Optional<String> status = ...; // this is prone to be empty

    return status.orElseThrow(
        () -> new NoSuchElementException("Status cannot be found"));
}
```

Or, another exception is, for example, `IllegalStateException`:

```
// Prefer
public String findStatus() {

    Optional<String> status = ...; // this is prone to be empty

    return status.orElseThrow(
        () -> new IllegalStateException("Status cannot be found"));
}
```

Starting with JDK 10, `Optional` was enriched with an `orElseThrow()` flavor without arguments. This method implicitly throws `NoSuchElementException`:

```
// Prefer (JDK 10+)
public String findStatus() {

    Optional<String> status = ...; // this is prone to be empty

    return status.orElseThrow();
}
```

Nevertheless, be aware that throwing an unchecked exception without a meaningful message in production is not good practice.

231. Optional and null references

It is possible to take advantage of `orElse(null)` by using a method that accepts the `null` references in certain situations.

A candidate for this scenario is `Method.invoke()` from the Java Reflection API (see Chapter 7, *Java Reflection Classes, Interfaces, Constructors, Methods, and Fields*).

The first argument of `Method.invoke()` represents the object instance on which this particular method is to be invoked. If the method is `static`, the first argument should be `null`, and so there is no need to have an instance of the object.

Let's assume that we have a class named `Book` and the helper method listed as follows.

This method returns an empty `Optional` class (if the given method is `static`) or an `Optional` class containing an instance of `Book` (if the given method is `non-static`):

```
private static Optional<Book> fetchBookInstance(Method method) {

    if (Modifier.isStatic(method.getModifiers())) {
        return Optional.empty();
    }

    return Optional.of(new Book());
}
```

Calling this method is pretty simple:

```
Method method = Book.class.getDeclaredMethod(...);

Optional<Book> bookInstance = fetchBookInstance(method);
```

Furthermore, if `Optional` is empty (meaning that the method is `static`), we need to pass `null` to `Method.invoke()`; otherwise, we pass the `Book` instance. A clumsy solution may rely on the `isPresent()-get()` pair, as follows:

```
// Avoid
if (bookInstance.isPresent()) {
    method.invoke(bookInstance.get());
} else {
    method.invoke(null);
}
```

But this is a perfect fit for `Optional.orElse(null)`. The following code reduces the solution to a single line of code:

```
// Prefer
method.invoke(bookInstance.orElse(null));
```



As a rule of thumb, we should use `orElse(null)` only when we have `Optional` and we need a `null` reference. Otherwise, avoid `orElse(null)`.

232. Consuming a present `Optional` class

Sometimes, all we want is to consume a present `Optional` class. If `Optional` is not present then nothing needs to be done. An unskillful solution will rely on the `isPresent()-get()` pair, as follows:

```
// Avoid
public void displayStatus() {
    Optional<String> status = ...; // this is prone to be empty

    if (status.isPresent()) {
        System.out.println(status.get());
    }
}
```

A better solution relies on `ifPresent()`, which takes `Consumer` as an argument. This is an alternative to the `isPresent()-get()` pair when we just need to consume the present value. The code can be rewritten as follows:

```
// Prefer
public void displayStatus() {
    Optional<String> status = ...; // this is prone to be empty

    status.ifPresent(System.out::println);
}
```

But in other cases, if `Optional` is not present then we want to execute an empty-based action. The solution based on the `isPresent()-get()` pair is as follows:

```
// Avoid
public void displayStatus() {
    Optional<String> status = ...; // this is prone to be empty

    if (status.isPresent()) {
        System.out.println(status.get());
    } else {
        System.out.println("Status not found ...");
    }
}
```

Again, this is not the best choice. Alternatively, we can count on `ifPresentOrElse()`. This method has been available since JDK 9 and is similar to the `ifPresent()` method; the only difference is that it covers the `else` branch as well:

```
// Prefer
public void displayStatus() {
    Optional<String> status = ...; // this is prone to be empty

    status.ifPresentOrElse(System.out::println,
        () -> System.out.println("Status not found ..."));
}
```

233. Returning a present Optional class or another one

Let's consider a method that returns an `Optional` class. Mainly, this method computes an `Optional` class and, if it isn't empty, then it simply returns this `Optional` class. Otherwise, if the computed `Optional` class is empty then we execute some other action that also returns `Optional` class.

The `isPresent()`-`get()` pair can do it as follows (this should be avoided):

```
private final static String BOOK_STATUS = "UNKNOWN";
...
// Avoid
public Optional<String> findStatus() {
    Optional<String> status = ...; // this is prone to be empty

    if (status.isPresent()) {
        return status;
    } else {
        return Optional.of(BOOK_STATUS);
    }
}
```

Alternatively, we should avoid such constructions as follow:

```
return Optional.of(status.orElse(BOOK_STATUS));
return Optional.of(status.orElseGet(() -> (BOOK_STATUS)));
```

The best solution has been available since with JDK 9, and it consists of the `Optional.or()` method. This method is capable of returning `Optional` describing the value. Otherwise, it returns `Optional` produced by the given `Supplier` function (the supplying function that produces `Optional` to be returned):

```
private final static String BOOK_STATUS = "UNKNOWN";
...
// Prefer
public Optional<String> findStatus() {
    Optional<String> status = ...; // this is prone to be empty

    return status.or(() -> Optional.of(BOOK_STATUS));
}
```

234. Chaining lambdas via `orElseFoo()`

Some operations specific to lambda expressions return `Optional` (for example, `findFirst()`, `findAny()`, `reduce()`, and so on). Trying to address these `Optional` classes via the `isPresent()`-`get()` pair is a cumbersome solution because we have to break the chain of lambdas, add some conditional code via the `if-else` blocks, and consider resuming the chain.

The following snippet of code shows this practice:

```
private static final String NOT_FOUND = "NOT FOUND";

List<Book> books...;
...
// Avoid
public String findFirstCheaperBook(int price) {

    Optional<Book> book = books.stream()
        .filter(b -> b.getPrice() < price)
        .findFirst();

    if (book.isPresent()) {
        return book.get().getName();
    } else {
        return NOT_FOUND;
    }
}
```

One step further and we may have something like the following:

```
// Avoid
public String findFirstCheaperBook(int price) {

    Optional<Book> book = books.stream()
        .filter(b -> b.getPrice() < price)
        .findFirst();

    return book.map(Book::getName)
        .orElse(NOT_FOUND);
}
```

Using `orElse()` instead of the `isPresent()-get()` pair is better. But it will be even better if we use `orElse()` (and `orElseFoo()`) directly in the chain of lambdas and avoid disrupted code:

```
private static final String NOT_FOUND = "NOT FOUND";
...
// Prefer
public String findFirstCheaperBook(int price) {

    return books.stream()
        .filter(b -> b.getPrice() < price)
        .findFirst()
        .map(Book::getName)
        .orElse(NOT_FOUND);
}
```

Let's have one more problem.

This time, we have an author of several books, and we want to check whether a certain book was written by this author. If our author didn't write the given book, then we want to throw `NoSuchElementException`.

A really bad solution to this will be as follows:

```
// Avoid
public void validateAuthorOfBook(Book book) {
    if (!author.isPresent() ||
        !author.get().getBooks().contains(book)) {
        throw new NoSuchElementException();
    }
}
```

On the other hand, using `orElseThrow()` can solve the problem very elegantly:

```
// Prefer
public void validateAuthorOfBook(Book book) {
    author.filter(a -> a.getBooks().contains(book))
        .orElseThrow();
}
```

235. Do not use Optional just for getting a value

This problem gives the start of a suite of problems from the *do not use* category. The *do not use* category tries to prevent the *overuse* of `Optional` and gives several rules that can save us a lot of trouble. Nevertheless, rules have exceptions. Therefore, do not conclude that the presented rules should be avoided at all costs. As always, it depends on the problem.

In the case of `Optional`, a common scenario involves chaining its methods for the single purpose of getting some value.

Avoid this practice and rely on simple and straightforward code. In other words, avoid doing something like the following snippet of code:

```
public static final String BOOK_STATUS = "UNKNOWN";
...
// Avoid
public String findStatus() {
    // fetch a status prone to be null
    String status = ...;

    return Optional.ofNullable(status).orElse(BOOK_STATUS);
}
```

And use a simple `if-else` block or the ternary operator (for simple cases):

```
// Prefer
public String findStatus() {
    // fetch a status prone to be null
    String status = null;

    return status == null ? BOOK_STATUS : status;
}
```

236. Do not use Optional for fields

The *do not use* category continues with the following statement—`Optional` was not intended to be used for fields and it doesn't implement `Serializable`.

The `Optional` class is definitively not intended to be used as a field of a JavaBean. So, do not do this:

```
// Avoid
public class Book {

    [access_modifier][static][final]
    Optional<String> title;
    [access_modifier][static][final]
    Optional<String> subtitle = Optional.empty();
    ...
}
```

But do this:

```
// Prefer
public class Book {

    [access_modifier][static][final] String title;
    [access_modifier][static][final] String subtitle = "";
    ...
}
```

237. Do not use `Optional` in constructor args

The *do not use* category continues with another scenario that is against the intention of using `Optional`. Keep in mind that `Optional` represents a container for objects; therefore, `Optional` adds another level of abstraction. In other words, improper use of `Optional` simply adds extra *boilerplate* code.

Check the following use case of `Optional` that shows this (this code violates the previous *Do not use `Optional` for fields* section):

```
// Avoid
public class Book {

    // cannot be null
    private final String title;

    // optional field, cannot be null
    private final Optional<String> isbn;

    public Book(String title, Optional<String> isbn) {
        this.title = Objects.requireNonNull(title,
            () -> "Title cannot be null");
    }
}
```



```
        if (isbn == null) {
            this.isbn = Optional.empty();
        } else {
            this.isbn = isbn;
        }

        // or
        this.isbn = Objects.requireNonNullElse(isbn, Optional.empty());
    }

    public String getTitle() {
        return title;
    }

    public Optional<String> getIsbn() {
        return isbn;
    }
}
```

We can fix this code by removing `Optional` from the fields and from the constructor arguments, as follows:

```
// Prefer
public class Book {

    private final String title; // cannot be null
    private final String isbn; // can be null

    public Book(String title, String isbn) {
        this.title = Objects.requireNonNull(title,
            () -> "Title cannot be null");
        this.isbn = isbn;
    }

    public String getTitle() {
        return title;
    }

    public Optional<String> getIsbn() {
        return Optional.ofNullable(isbn);
    }
}
```

The getter of `isbn` returns `Optional`. But do not consider this example as a rule for transforming all of your getters in this way. Some getters return collections or arrays, and, in that case, they prefer returning empty collections/arrays instead of `Optional`. Use this technique and keep in mind the statement of Brian Goetz (Java's language architect):

"I think routinely using it as a return value for getters would definitely be over-use."

- Brian Goetz

238. Do not use `Optional` in setter args

The *do not use* category continues with a very tempting scenario that consists of using `Optional` in setter arguments. The following code should be avoided since it adds extra boilerplate code and violates the *Do not use `Optional` for fields* section (check the `setIsbn()` method):

```
// Avoid
public class Book {

    private Optional<String> isbn;

    public Optional<String> getIsbn() {
        return isbn;
    }

    public void setIsbn(Optional<String> isbn) {
        if (isbn == null) {
            this.isbn = Optional.empty();
        } else {
            this.isbn = isbn;
        }

        // or
        this.isbn = Objects.requireNonNullElse(isbn, Optional.empty());
    }
}
```

We can fix this code by removing `Optional` from the fields and from the setters' arguments as follows:

```
// Prefer
public class Book {

    private String isbn;

    public Optional<String> getIsbn() {
        return Optional.ofNullable(isbn);
    }

    public void setIsbn(String isbn) {
        this.isbn = isbn;
    }
}
```



Commonly, this bad practice is used in JPA entities for persistent properties (to map an entity attribute as `Optional`). However, using `Optional` in domain model entities is possible.

239. Do not use `Optional` in method args

The *do not use* category continues with another common mistake of using `Optional`. This time let's address the usage of `Optional` in method arguments.

Using `Optional` in method arguments is just another use case that may lead to code that is unnecessarily complicated. Mainly, it is advisable to take responsibility for null-checking arguments instead of trusting that the callers will create `Optional` classes, especially empty `Optional` classes. This bad practice clutters the code and is still prone to `NullPointerException`. The caller can still pass `null`. So you have just turned back to checking `null` arguments.

Keep in mind that `Optional` is just another object (a container) and is not cheap. `Optional` consumes four times the memory of a bare reference!

As a conclusion, think twice before doing something like the following:

```
// Avoid
public void renderBook(Format format,
    Optional<Renderer> renderer, Optional<String> size) {

    Objects.requireNonNull(format, "Format cannot be null");
```

```
Renderer bookRenderer = renderer.orElseThrow(
    () -> new IllegalArgumentException("Renderer cannot be empty")
);

String bookSize = size.orElseGet(() -> "125 x 200");
...
}
```

Check the following call of this method that creates the required `Optional` class. But, obviously, passing `null` is possible as well and will result in `NullPointerException`, but this means that you intentionally defeat the purpose of `Optional`—don't think of polluting the preceding code with `null` checks for the `Optional` parameters; that would be a really bad idea:

```
Book book = new Book();

// Avoid
book.renderBook(new Format(),
    Optional.of(new CoolRenderer()), Optional.empty());

// Avoid
// lead to NPE
book.renderBook(new Format(),
    Optional.of(new CoolRenderer()), null);
```

We can fix this code by removing `Optional` classes as follows:

```
// Prefer
public void renderBook(Format format,
    Renderer renderer, String size) {

    Objects.requireNonNull(format, "Format cannot be null");
    Objects.requireNonNull(renderer, "Renderer cannot be null");

    String bookSize = Objects.requireNonNullElseGet(
        size, () -> "125 x 200");
    ...
}
```

This time, the call of this method doesn't force the creation of `Optional`:

```
Book book = new Book();

// Prefer
book.renderBook(new Format(), new CoolRenderer(), null);
```



When a method can accept optional parameters, rely on old-school method overloading, not on `Optional`.

240. Do not use `Optional` to return empty or null collections or arrays

Furthermore, in the *do not use* category, let's tackle the usage of `Optional` as the return type that wraps an empty or null collection or array.

Returning `Optional` that wraps an empty or null collection/array may be comprised of a clean and lightweight code. Check out the following code that shows this:

```
// Avoid
public Optional<List<Book>> fetchBooksByYear(int year) {
    // fetching the books may return null
    List<Book> books = ...;

    return Optional.ofNullable(books);
}

Optional<List<Book>> books = author.fetchBooksByYear(2021);

// Avoid
public Optional<Book[]> fetchBooksByYear(int year) {
    // fetching the books may return null
    Book[] books = ...;

    return Optional.ofNullable(books);
}

Optional<Book[]> books = author.fetchBooksByYear(2021);
```

We can clean this code by removing the unnecessary `Optional` and then rely on empty collections (for example, `Collections.emptyList()`, `emptyMap()`, and `emptySet()`) and arrays (for example, `new String[0]`). This is the preferable solution:

```
// Prefer
public List<Book> fetchBooksByYear(int year) {
    // fetching the books may return null
    List<Book> books = ...;

    return books == null ? Collections.emptyList() : books;
}

List<Book> books = author.fetchBooksByYear(2021);

// Prefer
public Book[] fetchBooksByYear(int year) {
    // fetching the books may return null
    Book[] books = ...;

    return books == null ? new Book[0] : books;
}

Book[] books = author.fetchBooksByYear(2021);
```

If you need to distinguish between a missing and an empty collection/array then throw an exception for the missing.

241. Avoiding `Optional` in collections

Relying on `Optional` in collections can be a design smell. Take another 30 minutes to re-evaluate the problem and discover better solutions.

The preceding statement is valid especially in the case of `Map` when the reason behind this decision sounds like this—so, `Map` returns `null` if there is no mapping for a key or if `null` is mapped to the key, so I cannot tell whether the key is not present or is a missing value. I will wrap the values via `Optional.ofNullable()` and `done!`

But what will we decide further if `Map of Optional<Foo>` is populated with `null` values, absent `Optional` values, or even `Optional` objects that contain something else, but not `Foo`? Haven't we just nested the initial problem into one more layer? How about the performance penalty? `Optional` is not cost free; it is just another object that consumes memory and needs to be collected.

So, let's consider a solution that should be avoided:

```
private static final String NOT_FOUND = "NOT FOUND";
...
// Avoid
Map<String, Optional<String>> isbnns = new HashMap<>();
isbnns.put("Book1", Optional.ofNullable(null));
isbnns.put("Book2", Optional.ofNullable("123-456-789"));
...
Optional<String> isbn = isbnns.get("Book1");

if (isbn == null) {
    System.out.println("This key cannot be found");
} else {
    String unwrappedIsbn = isbn.orElse(NOT_FOUND);
    System.out.println("Key found, Value: " + unwrappedIsbn);
}
```

A better and elegant solution can rely on JDK 8, `getOrDefault()` as follows:

```
private static String get(Map<String, String> map, String key) {
    return map.getOrDefault(key, NOT_FOUND);
}

Map<String, String> isbnns = new HashMap<>();
isbnns.put("Book1", null);
isbnns.put("Book2", "123-456-789");
...
String isbn1 = get(isbnns, "Book1"); // null
String isbn2 = get(isbnns, "Book2"); // 123-456-789
String isbn3 = get(isbnns, "Book3"); // NOT FOUND
```

Other solutions can rely on the following:

- The `containsKey()` method
- Trivial implementation by extending `HashMap`
- The JDK 8 `computeIfAbsent()` method
- Apache Commons `DefaultedMap`

We can conclude that there are always better solutions than using `Optional` in collections.

But the discussed use case from earlier is not the worst-case scenario. Here are two more that must be avoided:

```
Map<Optional<String>, String> items = new HashMap<>();
Map<Optional<String>, Optional<String>> items = new HashMap<>();
```

242. Confusing of() with ofNullable()

Confusing or mistakenly using `Optional.of()` instead of `Optional.ofNullable()`, or vice versa, can lead to weird behaviors and even `NullPointerException`.



`Optional.of(null)` **will throw** `NullPointerException`, while `Optional.ofNullable(null)` **will result in** `Optional.empty`.

Check the following failed attempt to write a snippet of code to avoid `NullPointerException`:

```
// Avoid
public Optional<String> isbn(String bookId) {
    // the fetched "isbn" can be null for the given "bookId"
    String isbn = ...;

    return Optional.of(isbn); // this throws NPE if "isbn" is null :(
}
```

But, most probably, we actually wanted to use `ofNullable()`, as follows:

```
// Prefer
public Optional<String> isbn(String bookId) {
    // the fetched "isbn" can be null for the given "bookId"
    String isbn = ...;

    return Optional.ofNullable(isbn);
}
```

Using `ofNullable()` instead of `of()` is not a disaster, but it may cause some confusion and bring no value. Check the following code:

```
// Avoid
// ofNullable() doesn't add any value
return Optional.ofNullable("123-456-789");

// Prefer
return Optional.of("123-456-789"); // no risk to NPE
```

Here is another problem. Let's assume that we want to convert an empty `String` object into an empty `Optional`. We may think that the proper solution will rely on `of()`, as follows:

```
// Avoid
Optional<String> result = Optional.of(str)
    .filter(not (String::isEmpty));
```

But remember that `String` can be `null`. This solution will work fine for empty or non-empty strings, but not for the `null` strings. Therefore, `ofNullable()` gives us the proper solution, as follows:

```
// Prefer
Optional<String> result = Optional.ofNullable(str)
    .filter(not (String::isEmpty));
```

243. `Optional<T>` versus `OptionalInt`

If there is no specific reason for using *boxed primitives*, then it is advisable to avoid `Optional<T>` and rely on non-generic `OptionalInt`, `OptionalLong`, or `OptionalDouble` type.

Boxing and unboxing are expensive operations that are prone to induce performance penalties. In order to eliminate this risk, we can rely on `OptionalInt`, `OptionalLong`, and `OptionalDouble`. These are wrappers for the `int`, `long`, and `double` primitive types.

So, avoid the following (and similar) solutions:

```
// Avoid
Optional<Integer> priceInt = Optional.of(50);
Optional<Long> priceLong = Optional.of(50L);
Optional<Double> priceDouble = Optional.of(49.99d);
```

And prefer the following solutions:

```
// Prefer
// unwrap via getAsInt()
OptionalInt priceInt = OptionalInt.of(50);

// unwrap via getAsLong()
OptionalLong priceLong = OptionalLong.of(50L);

// unwrap via getAsDouble()
OptionalDouble priceDouble = OptionalDouble.of(49.99d);
```

244. Asserting equality of Optionals

Having two `Optional` objects in `assertEquals()` doesn't require unwrapped values. This is applicable because `Optional.equals()` compares the wrapped values, not the `Optional` objects. This is the source code of `Optional.equals()`:

```
@Override
public boolean equals(Object obj) {

    if (this == obj) {
        return true;
    }

    if (!(obj instanceof Optional)) {
        return false;
    }

    Optional<?> other = (Optional<?>) obj;

    return Objects.equals(value, other.value);
}
```

Let's assume that we have two `Optional` objects:

```
Optional<String> actual = ...;
Optional<String> expected = ...;

// or
Optional actual = ...;
Optional expected = ...;
```

It is advisable to avoid a test written as follows:

```
// Avoid
@Test
public void givenOptionalsWhenTestEqualityThenTrue()
    throws Exception {

    assertEquals(expected.get(), actual.get());
}
```

If `expected` and/or `actual` is empty, then the `get()` method will cause an exception of the `NoSuchElementException` type.

It is better to use the following test:

```
// Prefer
@Test
public void givenOptionalsWhenTestEqualityThenTrue()
    throws Exception {

    assertEquals(expected, actual);
}
```

245. Transforming values via Map() and flatMap()

The `Optional.map()` and `flatMap()` methods are convenient for transforming an `Optional` value.

The `map()` method applies the function argument to the value, then returns the result wrapped in an `Optional` object. The `flatMap()` method applies the function argument to the value and then returns the result directly.

Let's assume that we have `Optional<String>`, and we want to transform this `String` from lowercase into uppercase. An uninspired solution can be written as follows:

```
Optional<String> lowername = ...; // may be empty as well

// Avoid
Optional<String> uppername;

if (lowername.isPresent()) {
    uppername = Optional.of(lowername.get().toUpperCase());
} else {
    uppername = Optional.empty();
}
```

A more inspired solution (in a single line of code) will rely on `Optional.map()`, as follows:

```
// Prefer
Optional<String> uppername = lowername.map(String::toUpperCase);
```

The `map()` method can be useful to avoid breaking a chain of lambdas as well. Let's consider `List<Book>`, and we want to find the first book that's \$50 cheaper and, if such a book exists, change its title to uppercase. Again, an uninspired solution will be as follows:

```
private static final String NOT_FOUND = "NOT FOUND";
List<Book> books = Arrays.asList();
...
// Avoid
Optional<Book> book = books.stream()
    .filter(b -> b.getPrice() < 50)
    .findFirst();

String title;
if (book.isPresent()) {
    title = book.get().getTitle().toUpperCase();
} else {
    title = NOT_FOUND;
}
```

Relying on `map()`, we can do it via the following chain of lambdas:

```
// Prefer
String title = books.stream()
    .filter(b -> b.getPrice() < 50)
    .findFirst()
    .map(Book::getTitle)
    .map(String::toUpperCase)
    .orElse(NOT_FOUND);
```

In the preceding example, the `getTitle()` method is a classical getter that returns the title of the book as `String`. But let's modify this getter to return `Optional`:

```
public Optional<String> getTitle() {
    return ...;
}
```

This time, we cannot use `map()` because `map(Book::getTitle)` will return `Optional<Optional<String>>` instead of `Optional<String>`. But if we rely on `flatMap()`, then the return of it will not be wrapped in an additional `Optional` object:

```
// Prefer
String title = books.stream()
    .filter(b -> b.getPrice() < 50)
    .findFirst()
    .flatMap(Book::getTitle)
```

```
.map(String::toUpperCase)
.orElse(NOT_FOUND);
```

So, `Optional.map()` wraps the result of transformation in an `Optional` object. If this result is `Optional` itself, then we obtain `Optional<Optional<...>>`. On the other hand, `flatMap()` does not wrap the result within an additional `Optional` object.

246. Filter values via `Optional.filter()`

Using `Optional.filter()` to accept or reject a wrapped value is a very convenient approach since it can be accomplished without explicitly unwrapping the value. We just pass a predicate (the condition) as an argument and get an `Optional` object (the initial `Optional` object if the condition is met or an empty `Optional` object if the condition is not met).

Let's consider the following uninspired approach for validating the length of a book ISBN:

```
// Avoid
public boolean validateIsbnLength(Book book) {

    Optional<String> isbn = book.getIsbn();

    if (isbn.isPresent()) {
        return isbn.get().length() > 10;
    }

    return false;
}
```

The preceding solution relies on explicitly unwrapping the `Optional` value. But if we rely on `Optional.filter()`, we can do it without this explicit unwrapping, as follows:

```
// Prefer
public boolean validateIsbnLength(Book book) {

    Optional<String> isbn = book.getIsbn();

    return isbn.filter((i) -> i.length() > 10)
               .isPresent();
}
```



`Optional.filter()` is also useful for avoiding breaking lambda chains.

247. Chaining the Optional and Stream APIs

Starting with JDK 9, we can refer to an `Optional` instance as `Stream` by applying the `Optional.stream()` method.

This is quite useful when we have to chain the `Optional` and `Stream` APIs. The `Optional.stream()` method returns a `Stream` of one element (the value of `Optional`) or an empty `Stream` (if `Optional` has no value). Furthermore, we can use all of the methods that are available in the `Stream` API.

Let's assume that we have a method for fetching books by ISBN (if no book matches the given ISBN, then this method returns an empty `Optional` object):

```
public Optional<Book> fetchBookByIsbn(String isbn) {
    // fetching book by the given "isbn" can return null
    Book book = ...;

    return Optional.ofNullable(book);
}
```

In addition to this, we loop a `List` of ISBNs and return `List` of `Book` as follows (each ISBN is passed through the `fetchBookByIsbn()` method):

```
// Avoid
public List<Book> fetchBooks(List<String> isbnns) {

    return isbnns.stream()
        .map(this::fetchBookByIsbn)
        .filter(Optional::isPresent)
        .map(Optional::get)
        .collect(toList());
}
```

The focus here is on the following two lines of code:

```
.filter(Optional::isPresent)
.map(Optional::get)
```

Since the `fetchBookByIsbn()` method can return empty `Optional` classes, we must ensure that we eliminate them from the final result. For this, we call `Stream.filter()` and apply the `Optional.isPresent()` function to each `Optional` object returned by `fetchBookByIsbn()`. So, after filtering, we have only `Optional` classes with present values. Furthermore, we apply the `Stream.map()` method for unwrapping these `Optional` classes to `Book`. Finally, we collect the `Book` objects in `List`.

But we can accomplish the same thing more elegantly using `Optional.stream()`, as follows:

```
// Prefer
public List<Book> fetchBooksPrefer(List<String> isbnns) {

    return isbnns.stream()
        .map(this::fetchBookByIsbn)
        .flatMap(Optional::stream)
        .collect(toList());
}
```



Practically, in cases like these, we can use `Optional.stream()` to replace `filter()` and `map()` with `flatMap()`.

Calling `Optional.stream()` for each `Optional<Book>` returned by `fetchBookByIsbn()` will result in `Stream<Book>` containing a single `Book` object or nothing (an empty stream). If `Optional<Book>` doesn't contain a value (is empty), then `Stream<Book>` is also empty. Relying on `flatMap()` instead of `map()` will avoid a result of the `Stream<Stream<Book>>` type.

As a bonus, we can convert `Optional` into `List` as follows:

```
public static<T> List<T> optionalToList(Optional<T> optional) {
    return optional.stream().collect(toList());
}
```

248. Optional and identity-sensitive operations

Identity-sensitive operations include reference equality (`==`), identity hash-based, or synchronization.

The `Optional` class is a *value-based* class such as `LocalDateTime`, therefore identity-sensitive operations should be avoided.

For example, let's test the equality of two `Optional` classes via `==`:

```
Book book = new Book();
Optional<Book> op1 = Optional.of(book);
Optional<Book> op2 = Optional.of(book);

// Avoid
// op1 == op2 => false, expected true
if (op1 == op2) {
    System.out.println("op1 is equal with op2, (via ==)");
} else {
    System.out.println("op1 is not equal with op2, (via ==)");
}
```

This will give the following output:

```
op1 is not equal with op2, (via ==)
```

Since `op1` and `op2` are not references to the same object, they are not equal so don't conform with the `==` implementation.

To compare the values, we need to rely on `equals()`, as follows:

```
// Prefer
if (op1.equals(op2)) {
    System.out.println("op1 is equal with op2, (via equals())");
} else {
    System.out.println("op1 is not equal with op2, (via equals())");
}
```

This will give the following output:

```
op1 is equal with op2, (via equals())
```

In the context of the identity-sensitive operations, never do something like this (think that `Optional` is a value-based class and such classes should not be used for locking—for more details, see <https://rules.sonarsource.com/java/tag/java8/RSPEC-3436>):

```
Optional<Book> book = Optional.of(new Book());
synchronized(book) {
    ...
}
```

249. Returning a boolean if the Optional class is empty

Let's assume that we have the following simple method:

```
public static Optional<Cart> fetchCart(long userId) {
    // the shopping cart of the given "userId" can be null
    Cart cart = ...;

    return Optional.ofNullable(cart);
}
```

Now, we want to write a method named `cartIsEmpty()` that calls the `fetchCart()` method and returns a flag that is `true` if the fetched cart is empty. Before JDK 11, we could implement this method based on `Optional.isPresent()`, as follows:

```
// Avoid (after JDK 11)
public static boolean cartIsEmpty(long id) {
    Optional<Cart> cart = fetchCart(id);

    return !cart.isPresent();
}
```

This solution works fine but is not very expressive. We check for emptiness via presence, and we have to negate the `isPresent()` result.

Since JDK 11, the `Optional` class has been enriched with a new method named `isEmpty()`. As its name suggests, this is a flag method that returns `true` if the tested `Optional` class is empty. So, we can increase the expressiveness of our solution as follows:

```
// Prefer (after JDK 11)
public static boolean cartIsEmpty(long id) {
    Optional<Cart> cart = fetchCart(id);

    return cart.isEmpty();
}
```

Summary

Done! This was the last problem of this chapter. At this point, you should have all of the arguments needed for using `Optional` correctly.

Download the applications from this chapter to see the results and to see the additional details.

13

The HTTP Client and WebSocket APIs

This chapter includes 20 problems that are meant to cover the HTTP Client and WebSocket APIs.

Do you remember `URLConnection`? Well, JDK 11 comes with the HTTP Client API as a reinvention of `URLConnection`. The HTTP Client API is easy to use and supports HTTP/2 (default) and HTTP/1.1. For backward compatibility, the HTTP Client API will automatically downgrade from HTTP/2 to HTTP 1.1 when the server doesn't support HTTP/2. Moreover, the HTTP Client API supports synchronous and asynchronous programming models and relies on streams to transfer data (reactive streams). It also supports the WebSocket protocol, which is used in real-time web applications to provide client-server communication with low message overhead.

Problems

Use the following problems to test your HTTP Client and WebSocket API programming prowess. I strongly encourage you to give each problem a try before you turn to the solutions and download the example programs:

250. **HTTP/2:** Provide a brief overview of the HTTP/2 protocol
251. **Triggering an asynchronous `GET` request:** Write a program that uses the HTTP Client API to trigger an asynchronous `GET` request and display the response code and body.
252. **Setting a proxy:** Write a program that uses the HTTP Client API to set up a connection via a proxy.
253. **Setting/getting headers:** Write a program that adds additional headers to the request and gets the headers of the response.

254. **Specifying the HTTP method:** Write a program that specifies the HTTP method of a request (for example, GET, POST, PUT, and DELETE).
255. **Setting the request body:** Write a program that uses the HTTP Client API to add a body to a request.
256. **Setting connection authentication:** Write a program that uses the HTTP Client API to set up a connection authentication via username and password.
257. **Setting a timeout:** Write a program that uses the HTTP Client API to set the amount of time we want to wait for a response (timeout).
258. **Setting the redirect policy:** Write a program that uses the HTTP Client API to automatically redirect if needed.
259. **Sending sync and async requests:** Write a program that sends the same request in sync and async modes.
260. **Handling cookies:** Write a program that uses the HTTP Client API to set a cookie handler.
261. **Getting response information:** Write a program that uses the HTTP Client API to get information about the response (for example, URI, version, headers, status code, body, and so on).
262. **Handling response body types:** Write several snippets of code to exemplify how to handle common response body types via `HttpResponse.BodyHandlers`.
263. **Getting, updating, and saving a JSON:** Write a program that uses the HTTP Client API to get, update, and save a JSON.
264. **Compression:** Write a program that handles compressed responses (for example, `.gzip`).
265. **Handling form data:** Write a program that uses the HTTP Client API to submit a data form (`application/x-www-form-urlencoded`).
266. **Downloading a resource:** Write a program that uses the HTTP Client API to download a resource.
267. **Uploading with multipart:** Write a program that uses the HTTP Client API to upload a resource.
268. **HTTP/2 server push:** Write a program that exemplifies the HTTP/2 server push feature via the HTTP Client API.
269. **WebSocket:** Write a program that opens a connection to a WebSocket endpoint, collects data for 10 seconds, and closes the connection.

Solutions

The following sections describe the solutions to the preceding problems. Remember that there usually isn't a single correct way to solve a particular problem. Also, remember that the explanations that are shown here only include the most interesting and important details that are needed to solve the problems. You can download the example solutions to view additional details and experiment with the programs from <https://github.com/PacktPublishing/Java-Coding-Problems>.

250. HTTP/2

HTTP/2 is an efficient protocol that substantially and measurably improves the **HTTP/1.1** protocol.

As part of a bigger picture, **HTTP/2** has two parts:

- **The framing layer:** This is the **HTTP/2** multiplexing core ability
- **The data layer:** This contains the data (what we typically refer to as HTTP)

The following diagram depicts the communication in **HTTP/1.1** (top) and **HTTP/2** (bottom):

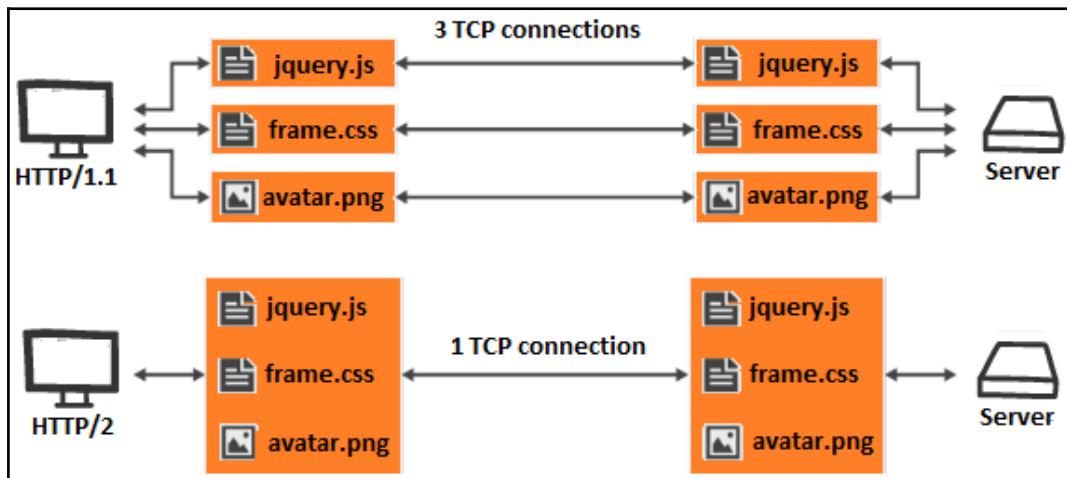

HTTP/2 is widely adopted by servers and browsers, and it comes with the following improvements over **HTTP/1.1**:

- **Binary protocol:** Less readable by humans but more machine friendly, the **HTTP/2 framing layer** is a binary framed protocol.
- **Multiplexing:** This refers to interwoven requests and responses. Multiple requests run at the same time on the same connection.
- **Server push:** The server can decide to send additional resources to the client.
- **Single connection to server:** **HTTP/2** uses a single communication line (TCP connection) per origin (domain).
- **Header compression:** **HTTP/2** relies on HPACK compression to reduce headers. This has a significant impact on redundant bytes.
- **Encrypted:** Most of the data that's transferred over the wires is encrypted.

251. Triggering an asynchronous GET request

Triggering asynchronous GET request is a three-step job, as follows:

1. Create a new `HttpClient` object (`java.net.http.HttpClient`):

```
HttpClient client = HttpClient.newHttpClient();
```

2. Build an `HttpRequest` object (`java.net.http.HttpRequest`) and specify the request (by default, this is a GET request):

```
HttpRequest request = HttpRequest.newBuilder()  
    .uri(URI.create("https://reqres.in/api/users/2"))  
    .build();
```



For setting the URI, we can call the

`HttpRequest.newBuilder(URI)` constructor or call the `uri(URI)` method on the `Builder` instance (like we did previously).

3. Trigger the request and wait for the response (`java.net.http.HttpResponse`). Being a synchronous request, the application will block until the response is available:

```
HttpResponse<String> response  
    = client.send(request, BodyHandlers.ofString());
```

If we group these three steps and add the lines for displaying the response code and body at the console, then we obtain the following code:

```
HttpClient client = HttpClient.newHttpClient();

HttpRequest request = HttpRequest.newBuilder()
    .uri(URI.create("https://reqres.in/api/users/2"))
    .build();

HttpResponse<String> response
    = client.send(request, BodyHandlers.ofString());

System.out.println("Status code: " + response.statusCode());
System.out.println("\n Body: " + response.body());
```

One possible output for the preceding code is as follows:

```
Status code: 200
Body:
{
  "data": {
    "id": 2,
    "email": "janet.weaver@reqres.in",
    "first_name": "Janet",
    "last_name": "Weaver",
    "avatar": "https://s3.amazonaws.com/..."
  }
}
```

By default, this request takes place using HTTP/2. However, we can explicitly set the version via `HttpRequest.Builder.version()` as well. This method gets an argument of the `HttpClient.Version` type, which is an enum data type that exposes two constants: `HTTP_2` and `HTTP_1_1`. The following is an example of explicitly downgrading to HTTP/1.1:

```
HttpRequest request = HttpRequest.newBuilder()
    .version(HttpClient.Version.HTTP_1_1)
    .uri(URI.create("https://reqres.in/api/users/2"))
    .build();
```

The default settings for `HttpClient` are as follows:

- HTTP/2
- No authenticator
- No connection timeout
- No cookie handler

- Default thread pool executor
- Redirection policy of `NEVER`
- Default proxy selector
- Default SSL context

We'll take a look at the query parameter builder in the next section.

Query parameter builder

Working with URIs that contain query parameters implies encoding these parameters. The Java built-in method for accomplishing this task is `URLEncoder.encode()`. But concatenating and encoding several query parameters leads to something similar to the following:

```
URI uri = URI.create("http://localhost:8080/books?name=" +
    URLEncoder.encode("Games & Fun!", StandardCharsets.UTF_8) +
    "&no=" + URLEncoder.encode("124#442#000", StandardCharsets.UTF_8) +
    "&price=" + URLEncoder.encode("$23.99", StandardCharsets.UTF_8)
);
```

When we have to work with a significant number of query parameters, this solution is not very convenient. We can, however, try to write a helper method to hide the `URLEncoder.encode()` method in a loop over a collection of query parameters, or we can rely on a URI builder.

In Spring, the URI builder is

`org.springframework.web.util.UriComponentsBuilder`. The following code is self-explanatory:

```
URI uri = UriComponentsBuilder.newInstance()
    .scheme("http")
    .host("localhost")
    .port(8080)
    .path("books")
    .QueryParam("name", "Games & Fun!")
    .QueryParam("no", "124#442#000")
    .QueryParam("price", "$23.99")
    .build()
    .toUri();
```

In a non-Spring application, we can rely on a URI builder such as the `urlbuilder` library (<https://github.com/mikaelhg/urlbuilder>). The code that's bundled with this book contains an example of using this.

252. Setting a proxy

To set up a proxy, we rely on the `HttpClient.proxy()` method of a `Builder` method. The `proxy()` method gets an argument of the `ProxySelector` type, which can be the system-wide proxy selector (via `getDefault()`) or the proxy selector that's pointed to via its address (via `InetSocketAddress`).

Let's assume that we have a proxy at the `proxy.host:80` address. We can set up this proxy as follows:

```
HttpClient client = HttpClient.newBuilder()
    .proxy(ProxySelector.of(new InetSocketAddress("proxy.host", 80)))
    .build();
```

Alternatively, we can set up the system-wide proxy selector, as follows:

```
HttpClient client = HttpClient.newBuilder()
    .proxy(ProxySelector.getDefault())
    .build();
```

253. Setting/getting headers

`HttpRequest` and `HttpResponse` expose a suite of methods for working with headers. We'll learn about these methods in the upcoming sections.

Setting request headers

The `HttpRequest.Builder` class uses three methods to set additional headers:

- `header(String name, String value)` and `setHeader(String name, String value)`: These are used to add headers one by one, as shown in the following code:

```
HttpRequest request = HttpRequest.newBuilder()
    .uri(...)
    ...
    .header("key_1", "value_1")
    .header("key_2", "value_2")
    ...
    .build();

HttpRequest request = HttpRequest.newBuilder()
    .uri(...)
```

```
...
.setHeader("key_1", "value_1")
.setHeader("key_2", "value_2")
...
.build();
```



The difference between `header()` and `setHeader()` is that the former adds the specified header while the latter sets the specified header. In other words, `header()` adds the given value to the list of values for that name/key, while `setHeader()` overwrites any previously set values for that name/key.

- `headers(String... headers)`: This is used to add headers separated by a comma, as shown in the following code:

```
HttpRequest request = HttpRequest.newBuilder()
    .uri(...)
    ...
    .headers("key_1", "value_1", "key_2",
            "value_2", "key_3", "value_3", ...)
    ...
    .build();
```

For example, the `Content-Type: application/json` and `Referer: https://reqres.in/` headers can be added to the request that's triggered by the `https://reqres.in/api/users/2` URI, as follows:

```
HttpRequest request = HttpRequest.newBuilder()
    .header("Content-Type", "application/json")
    .header("Referer", "https://reqres.in/")
    .uri(URI.create("https://reqres.in/api/users/2"))
    .build();
```

You can also do the following:

```
HttpRequest request = HttpRequest.newBuilder()
    .setHeader("Content-Type", "application/json")
    .setHeader("Referer", "https://reqres.in/")
    .uri(URI.create("https://reqres.in/api/users/2"))
    .build();
```

Finally, you can do something like this:

```
HttpRequest request = HttpRequest.newBuilder()
    .headers("Content-Type", "application/json",
            "Referer", "https://reqres.in/")
    .uri(URI.create("https://reqres.in/api/users/2"))
    .build();
```

Depending on the goal, all three methods can be combined in order to specify the request headers.

Getting request/response headers

Getting the request headers can be done using the `HttpRequest.headers()` method. A similar method exists in `HttpResponse` for getting the headers of the response. Both methods return an `HttpHeaders` object.

Both of these methods can be used in the same way, so let's focus on getting the response headers. We can get the headers like so:

```
HttpResponse<...> response ...
HttpHeaders allHeaders = response.headers();
```

Getting all of the values of a header can be done using `HttpHeaders.allValues()`, as follows:

```
List<String> allValuesOfCacheControl
    = response.headers().allValues("Cache-Control");
```

Getting only the first value of a header can be done using `HttpHeaders.firstValue()`, as follows:

```
Optional<String> firstValueOfCacheControl
    = response.headers().firstValue("Cache-Control");
```



If the returned value of a header is `Long`, then rely on `HttpHeaders.firstValueAsLong()`. This method gets an argument representing the name of the header and returns `Optional<Long>`. If the value of the specified header cannot be parsed as `Long`, then `NumberFormatException` will be thrown.

254. Specifying the HTTP method

We can indicate the HTTP method that's used by our request using the following methods from `HttpRequest.Builder`:

- `GET()`: This method sends the request using the HTTP `GET` method, as shown in the following example:

```
HttpRequest requestGet = HttpRequest.newBuilder()
    .GET() // can be omitted since it is default
    .uri(URI.create("https://reqres.in/api/users/2"))
    .build();
```

- `POST()`: This method sends the request using the HTTP `POST` method, as shown in the following example:

```
HttpRequest requestPost = HttpRequest.newBuilder()
    .header("Content-Type", "application/json")
    .POST(HttpRequest.BodyPublishers.ofString(
        "{\"name\": \"morpheus\", \"job\": \"leader\"}"))
    .uri(URI.create("https://reqres.in/api/users"))
    .build();
```

- `PUT()`: This method sends the request using the HTTP `PUT` method, as shown in the following example:

```
HttpRequest requestPut = HttpRequest.newBuilder()
    .header("Content-Type", "application/json")
    .PUT(HttpRequest.BodyPublishers.ofString(
        "{\"name\": \"morpheus\", \"job\": \"zion resident\"}"))
    .uri(URI.create("https://reqres.in/api/users/2"))
    .build();
```

- `DELETE()`: This method sends the request using the HTTP `DELETE` method, as shown in the following example:

```
HttpRequest requestDelete = HttpRequest.newBuilder()
    .DELETE()
    .uri(URI.create("https://reqres.in/api/users/2"))
    .build();
```

The client can handle all types of HTTP methods, not only the predefined methods (`GET`, `POST`, `PUT`, and `DELETE`). To create a request with a different HTTP method, we just need to call `method()`.

The following solution triggers an HTTP PATCH request:

```
HttpRequest requestPatch = HttpRequest.newBuilder()
    .header("Content-Type", "application/json")
    .method("PATCH", HttpRequest.BodyPublishers.ofString(
        "{\"name\": \"morpheus\", \"job\": \"zion resident\"}"))
    .uri(URI.create("https://reqres.in/api/users/1"))
    .build();
```

When no request body is required, we can rely on `BodyPublishers.noBody()`. The following solution uses the `noBody()` method to trigger an HTTP HEAD request:

```
HttpRequest requestHead = HttpRequest.newBuilder()
    .method("HEAD", HttpRequest.BodyPublishers.noBody())
    .uri(URI.create("https://reqres.in/api/users/1"))
    .build();
```

In the case of multiple similar requests, we can rely on the `copy()` method to copy the builder, as shown in the following snippet of code:

```
HttpRequest.Builder builder = HttpRequest.newBuilder()
    .uri(URI.create("..."));

HttpRequest request1 = builder.copy().setHeader("...", "...").build();
HttpRequest request2 = builder.copy().setHeader("...", "...").build();
```

255. Setting a request body

Setting a request body can be accomplished using `HttpRequest.Builder.POST()` and `HttpRequest.Builder.PUT()` or by using `method()` (for example, `method("PATCH", HttpRequest.BodyPublisher)`). `POST()` and `PUT()` take an argument of the `HttpRequest.BodyPublisher` type. The API comes with several implementations of this interface (`BodyPublisher`) in the `HttpRequest.BodyPublishers` class, as follows:

- `BodyPublishers.ofString()`
- `BodyPublishers.ofFile()`
- `BodyPublishers.ofByteArray()`
- `BodyPublishers.ofInputStream()`

We'll take a look at these implementations in the following sections.

Creating a body from a string

Creating a body from a string can be accomplished using

`BodyPublishers.ofString()`, as shown in the following snippet of code:

```
HttpRequest requestBody = HttpRequest.newBuilder()
    .header("Content-Type", "application/json")
    .POST(HttpRequest.BodyPublishers.ofString(
        "{ \"name\": \"morpheus\", \"job\": \"leader\" }"))
    .uri(URI.create("https://reqres.in/api/users"))
    .build();
```

For specifying a charset call, use `ofString(String s, Charset charset)`.

Creating a body from InputStream

Creating a body from `InputStream` can be accomplished using

`BodyPublishers.ofInputStream()`, as shown in the following snippet of code (here, we rely on `ByteArrayInputStream` but, of course, any other `InputStream` is suitable):

```
HttpRequest requestBodyOfInputStream = HttpRequest.newBuilder()
    .header("Content-Type", "application/json")
    .POST(HttpRequest.BodyPublishers.ofInputStream(()
        -> inputStream("user.json")))
    .uri(URI.create("https://reqres.in/api/users"))
    .build();

private static ByteArrayInputStream inputStream(String fileName) {

    try (ByteArrayInputStream inputStream = new ByteArrayInputStream(
        Files.readAllBytes(Path.of(fileName)))) {

        return inputStream;
    } catch (IOException ex) {
        throw new RuntimeException("File could not be read", ex);
    }
}
```

In order to take advantage of lazy creation, `InputStream` has to be passed as `Supplier`.

Creating a body from a byte array

Creating a body from a byte array can be accomplished using `BodyPublishers.ofByteArray()`, as shown in the following snippet of code:

```
HttpRequest requestBodyOfByteArray = HttpRequest.newBuilder()
    .header("Content-Type", "application/json")
    .POST(HttpRequest.BodyPublishers.ofByteArray(
        Files.readAllBytes(Path.of("user.json"))))
    .uri(URI.create("https://reqres.in/api/users"))
    .build();
```

We can also send only a part of the byte array using `ofByteArray(byte[] buf, int offset, int length)`. Moreover, we can provide data from `Iterable` of byte arrays using `ofByteArrays(Iterable<byte[]> iter)`.

Creating a body from a file

Creating a body from a file can be accomplished using `BodyPublishers.ofFile()`, as shown in the following snippet of code:

```
HttpRequest requestBodyOfFile = HttpRequest.newBuilder()
    .header("Content-Type", "application/json")
    .POST(HttpRequest.BodyPublishers.ofFile(Path.of("user.json")))
    .uri(URI.create("https://reqres.in/api/users"))
    .build();
```

256. Setting connection authentication

Typically, authentication to a server is accomplished using a username and password. In code form, this can be done by using the `Authenticator` class (this negotiates the credentials for HTTP authentication) and the `PasswordAuthentication` class (the holder for the username and password) together, as follows:

```
HttpClient client = HttpClient.newBuilder()
    .authenticator(new Authenticator() {

        @Override
        protected PasswordAuthentication getPasswordAuthentication() {

            return new PasswordAuthentication(
                "username",
                "password".toCharArray());
        }
    });
```

```
    })  
    .build();
```

Furthermore, the client can be used to send requests:

```
HttpRequest request = HttpRequest.newBuilder()  
    ...  
    .build();  
  
HttpResponse<String> response  
    = client.send(request, HttpResponse.BodyHandlers.ofString());
```



Authenticator supports different authentication schemes (for example, *basic* or *digest* authentication).

Another solution consists of adding credentials in the header, as follows:

```
HttpClient client = HttpClient.newHttpClient();  
  
HttpRequest request = HttpRequest.newBuilder()  
    .header("Authorization", basicAuth("username", "password"))  
    ...  
    .build();  
  
HttpResponse<String> response  
    = client.send(request, HttpResponse.BodyHandlers.ofString());  
  
private static String basicAuth(String username, String password) {  
    return "Basic " + Base64.getEncoder().encodeToString(  
        (username + ":" + password).getBytes());  
}
```

In the case of a Bearer authentication (HTTP bearer token), we do the following:

```
HttpRequest request = HttpRequest.newBuilder()  
    .header("Authorization",  
        "Bearer mT8JNMyWCG0D7waCHkyxo0Hm80YBqelv5SBL")  
    .uri(URI.create("https://gorest.co.in/public-api/users"))  
    .build();
```

We can also do this in the body of a POST request:

```
HttpClient client = HttpClient.newHttpClient();  
  
HttpRequest request = HttpRequest.newBuilder()  
    .header("Content-Type", "application/json")
```



```
.POST(BodyPublishers.ofString("{\n\"email\":\n\"eve.holt@reqres.in\",  
  \n\"password\":\n\"cityslicka\"}"))  
.uri(URI.create("https://reqres.in/api/login"))  
.build();
```

```
HttpResponse<String> response  
= client.send(request, HttpResponse.BodyHandlers.ofString());
```



Different requests can use different credentials. Moreover, `Authenticator` provides a suite of methods (for example, `getRequestingSite()`) that are useful if we wish to find out what values should be provided. In production, the application should not provide the credentials in plaintext, like they were in these examples.

257. Setting a timeout

By default, a request has no timeout (infinite timeout). To set the amount of time we want to wait for a response (timeout), we can call the

`HttpRequest.Builder.timeout()` method. This method gets an argument of the `Duration` type, which can be used like so:

```
HttpRequest request = HttpRequest.newBuilder()  
  .uri(URI.create("https://reqres.in/api/users/2"))  
  .timeout(Duration.of(5, ChronoUnit.MILLIS))  
  .build();
```

If the specified timeout elapses, then `java.net.http.HttpConnectTimeoutException` will be thrown.

258. Setting the redirect policy

When we try to access a resource that was moved to a different URI, the server will return an HTTP status code in the range of `3xx`, as well as information about the new URI. Browsers are capable of automatically sending another request to the new location when they receive a redirect response (301, 302, 303, 307, and 308).

The HTTP Client API can automatically redirect to this new URI if we explicitly set the redirect policy via `followRedirects()`, as follows:

```
HttpClient client = HttpClient.newBuilder()
    .followRedirects(HttpClient.Redirect.ALWAYS)
    .build();
```

To never redirect, just give the `HttpClient.Redirect.NEVER` constant to `followRedirects()` (this is the default).

To always redirect, except from HTTPS URLs to HTTP URLs, just give the `HttpClient.Redirect.NORMAL` constant to `followRedirects()`.

When the redirect policy is not set to `ALWAYS`, the application is responsible for handling redirects. Commonly, this is accomplished by reading the new address from the `HTTP Location` header, as follows (the following code is only interested in redirecting if the returned status code is 301 (moved permanently) or 308 (permanent redirect)):

```
int sc = response.statusCode();

if (sc == 301 || sc == 308) { // use an enum for HTTP response codes
    String newLocation = response.headers()
        .firstValue("Location").orElse("");

    // handle the redirection to newLocation
}
```

A redirect can be easily detected by comparing the request URI with the response URI. If they are not the same, then a redirect occurs:

```
if (!request.uri().equals(response.uri())) {
    System.out.println("The request was redirected to: "
        + response.uri());
}
```

259. Sending sync and async requests

Sending a request to a server can be accomplished using the following two methods from `HttpClient`:

- `send()`: This method sends a request synchronously (this will block until the response is available or a timeout occurs)
- `sendAsync()`: This method sends a request asynchronously (non-blocking)

We'll explain the different ways we can send a request in the next section.

Sending a request synchronously

We've already done this in the previous problems, and so we will just provide you with a quick remainder, as follows:

```
HttpClient client = HttpClient.newHttpClient();

HttpRequest request = HttpRequest.newBuilder()
    .uri(URI.create("https://reqres.in/api/users/2"))
    .build();

HttpResponse<String> response
    = client.send(request, HttpResponse.BodyHandlers.ofString());
```

Sending a request asynchronously

In order to send requests asynchronously, the HTTP Client API relies on `CompletableFuture`, as discussed in Chapter 11, *Concurrency – Deep Dive*, and the `sendAsync()` method, as follows:

```
HttpClient client = HttpClient.newHttpClient();

HttpRequest request = HttpRequest.newBuilder()
    .uri(URI.create("https://reqres.in/api/users/2"))
    .build();

client.sendAsync(request, HttpResponse.BodyHandlers.ofString())
    .thenApply(HttpResponse::body)
    .exceptionally(e -> "Exception: " + e)
    .thenAccept(System.out::println)
    .get(30, TimeUnit.SECONDS); // or join()
```

Alternatively, let's assume that, while waiting for the response, we want to execute other tasks as well:

```
HttpClient client = HttpClient.newHttpClient();

HttpRequest request = HttpRequest.newBuilder()
    .uri(URI.create("https://reqres.in/api/users/2"))
    .build();

CompletableFuture<String> response
    = client.sendAsync(request, HttpResponse.BodyHandlers.ofString())
```

```
.thenApply(HttpResponse::body)
.exceptionally(e -> "Exception: " + e);

while (!response.isDone()) {
    Thread.sleep(50);
    System.out.println("Perform other tasks
        while waiting for the response ...");
}

String body = response.get(30, TimeUnit.SECONDS); // or join()
System.out.println("Body: " + body);
```

Sending multiple requests concurrently

How do we send multiple requests concurrently and wait for all of the responses to be available?

As we know, `CompletableFuture` comes with the `allOf()` method (for more details, please read [Chapter 11, Concurrency – Deep Dive](#)), which can execute tasks in parallel and waits for all of them to complete. `CompletableFuture<Void>` is returned.

The following code waits for the responses to four requests:

```
List<URI> uris = Arrays.asList(
    new URI("https://reqres.in/api/users/2"), // one user
    new URI("https://reqres.in/api/users?page=2"), // list of users
    new URI("https://reqres.in/api/unknown/2"), // list of resources
    new URI("https://reqres.in/api/users/23")); // user not found

HttpClient client = HttpClient.newHttpClient();

List<HttpRequest> requests = uris.stream()
    .map(HttpRequest::newBuilder)
    .map(reqBuilder -> reqBuilder.build())
    .collect(Collectors.toList());

CompletableFuture.allOf(requests.stream()
    .map(req -> client.sendAsync(
        req, HttpResponse.BodyHandlers.ofString())
    .thenApply((res) -> res.uri() + " | " + res.body() + "\n")
    .exceptionally(e -> "Exception: " + e)
    .thenAccept(System.out::println))
    .toArray(CompletableFuture<?>[]::new))
    .join();
```

To collect the bodies of the responses (for example, in `List<String>`), consider the `WaitAllResponsesFetchBodiesInList` class, which is available in the code that's bundled with this book.

Using a custom `Executor` object can be accomplished as follows:

```
ExecutorService executor = Executors.newFixedThreadPool(5);

HttpClient client = HttpClient.newBuilder()
    .executor(executor)
    .build();
```

260. Handling cookies

By default, JDK 11's HTTP Client supports cookies, but there are instances where built-in support is disabled. We can enable it as follows:

```
HttpClient client = HttpClient.newBuilder()
    .cookieHandler(new CookieManager())
    .build();
```

So, the HTTP Client API allows us to set a cookie handler using the `HttpClient.Builder.cookieHandler()` method. This method gets an argument of the `CookieManager` type.

The following solution sets `CookieManager` that doesn't accept cookies:

```
HttpClient client = HttpClient.newBuilder()
    .cookieHandler(new CookieManager(null, CookiePolicy.ACCEPT_NONE))
    .build();
```

For accepting cookies, set `CookiePolicy` to `ALL` (accept all cookies) or `ACCEPT_ORIGINAL_SERVER` (accept cookies only from the original server).

The following solutions accept all cookies and display them in the console (if any credentials are reported as invalid, then consider obtaining a new token from `https://gorest.co.in/rest-console.html`):

```
CookieManager cm = new CookieManager();
cm.setCookiePolicy(CookiePolicy.ACCEPT_ALL);

HttpClient client = HttpClient.newBuilder()
    .cookieHandler(cm)
    .build();
```

```
HttpRequest request = HttpRequest.newBuilder()
    .header("Authorization",
           "Bearer mT8JNMyWCG0D7waCHkyxo0Hm80YBqelv5SBL")
    .uri(URI.create("https://gorest.co.in/public-api/users/1"))
    .build();

HttpResponse<String> response
    = client.send(request, HttpResponse.BodyHandlers.ofString());

System.out.println("Status code: " + response.statusCode());
System.out.println("\n Body: " + response.body());

CookieStore cookieStore = cm.getCookieStore();
System.out.println("\nCookies: " + cookieStore.getCookies());
```

Checking the `set-cookie` header can be done as follows:

```
Optional<String> setcookie
    = response.headers().firstValue("set-cookie");
```

261. Getting response information

In order to get information about the response, we can rely on the methods from the `HttpResponse` class. The names of these methods are very intuitive; therefore, the following snippet of code is self-explanatory:

```
...
HttpResponse<String> response
    = client.send(request, HttpResponse.BodyHandlers.ofString());

System.out.println("Version: " + response.version());
System.out.println("\nURI: " + response.uri());
System.out.println("\nStatus code: " + response.statusCode());
System.out.println("\nHeaders: " + response.headers());
System.out.println("\n Body: " + response.body());
```

Consider exploring the documentation to find more useful methods.

262. Handling response body types

Handling response body types can be accomplished using `HttpResponse.BodyHandler`. The API comes with several implementations of this interface (`BodyHandler`) in the `HttpResponse.BodyHandlers` class, as follows:

- `BodyHandlers.ofByteArray()`
- `BodyHandlers.ofFile()`
- `BodyHandlers.ofString()`
- `BodyHandlers.ofInputStream()`
- `BodyHandlers.ofLines()`

Considering the following request, let's look at several solutions for handling the response body:

```
HttpClient client = HttpClient.newHttpClient();

HttpRequest request = HttpRequest.newBuilder()
    .uri(URI.create("https://reqres.in/api/users/2"))
    .build();
```

We'll look at how to handle different types of response bodies in the following sections.

Handling a response body as a string

Handling a body response as a string can be accomplished using `BodyHandlers.ofString()`, as shown in the following snippet of code:

```
HttpResponse<String> responseOfString
    = client.send(request, HttpResponse.BodyHandlers.ofString());

System.out.println("Status code: " + responseOfString.statusCode());
System.out.println("Body: " + responseOfString.body());
```

For specifying a charset, call `ofString(String s, Charset charset)`.

Handling a response body as a file

Handling a body response as a file can be accomplished using `BodyHandlers.ofFile()`, as shown in the following snippet of code:

```
HttpResponse<Path> responseOfFile = client.send(
    request, HttpResponse.BodyHandlers.ofFile(
        Path.of("response.json")));

System.out.println("Status code: " + responseOfFile.statusCode());
System.out.println("Body: " + responseOfFile.body());
```

For specifying the open options, call `ofFile(Path file, OpenOption... openOptions)`.

Handling a response body as a byte array

Handling a body response as a byte array can be accomplished using `BodyHandlers.ofByteArray()`, as shown in the following snippet of code:

```
HttpResponse<byte[]> responseOfByteArray = client.send(
    request, HttpResponse.BodyHandlers.ofByteArray());

System.out.println("Status code: "
    + responseOfByteArray.statusCode());
System.out.println("Body: "
    + new String(responseOfByteArray.body()));
```

For consuming the byte array, call `ofByteArrayConsumer(Consumer<Optional<byte[]>> consumer)`.

Handling a response body as an input stream

Handling a body response as `InputStream` can be accomplished using `BodyHandlers.ofInputStream()`, as shown in the following snippet of code:

```
HttpResponse<InputStream> responseOfInputStream = client.send(
    request, HttpResponse.BodyHandlers.ofInputStream());

System.out.println("\nHttpResponse.BodyHandlers.ofInputStream():");
System.out.println("Status code: "
    + responseOfInputStream.statusCode());

byte[] allBytes;
```



```
try (InputStream fromIs = responseOfInputStream.body()) {
    allBytes = fromIs.readAllBytes();
}

System.out.println("Body: "
    + new String(allBytes, StandardCharsets.UTF_8));
```

Handling a response body as a stream of strings

Handling a body response as a stream of strings can be accomplished using `BodyHandlers.ofLines()`, as shown in the following snippet of code:

```
HttpResponse<Stream<String>> responseOfLines = client.send(
    request, HttpResponse.BodyHandlers.ofLines());

System.out.println("Status code: " + responseOfLines.statusCode());
System.out.println("Body: "
    + responseOfLines.body().collect(toList()));
```

263. Getting, updating, and saving a JSON

In the previous problems, we manipulated JSON data as plaintext (strings). The HTTP Client API doesn't provide special or dedicated support for JSON data and treats this kind of data as any other string.

Nevertheless, we are used to representing JSON data as Java objects (POJOs) and relying on the conversion between JSON and Java when needed. We can write a solution to our problem without involving the HTTP Client API. However, we can also write a solution using a custom implementation of `HttpResponse.BodyHandler` that relies on a JSON parser to convert the response into Java objects. For example, we can rely on JSON-B (introduced in [Chapter 6, Java I/O Paths, Files, Buffers, Scanning, and Formatting](#)).

Implementing the `HttpResponse.BodyHandler` interface implies overriding the `apply(HttpResponse.ResponseInfo responseInfo)` method. Using this method, we can take the bytes from the response and convert them into a Java object. The code is as follows:

```
public class JsonBodyHandler<T>
    implements HttpResponse.BodyHandler<T> {

    private final Jsonb jsonb;
    private final Class<T> type;
```

```
private JsonBodyHandler(Jsonb jsonb, Class<T> type) {
    this.jsonb = jsonb;
    this.type = type;
}

public static <T> JsonBodyHandler<T>
    jsonBodyHandler(Class<T> type) {
    return jsonBodyHandler(JsonbBuilder.create(), type);
}

public static <T> JsonBodyHandler<T> jsonBodyHandler(
    Jsonb jsonb, Class<T> type) {
    return new JsonBodyHandler<>(jsonb, type);
}

@Override
public HttpResponse.BodySubscriber<T> apply(
    HttpResponse.ResponseInfo responseInfo) {

    return BodySubscribers.mapping(BodySubscribers.ofByteArray(),
        byteArray -> this.jsonb.fromJson(
            new ByteArrayInputStream(byteArray), this.type));
}
}
```

Let's assume that the JSON that we want to manipulate looks like the following (this is the response from the server):

```
{
  "data": {
    "id": 2,
    "email": "janet.weaver@reqres.in",
    "first_name": "Janet",
    "last_name": "Weaver",
    "avatar": "https://s3.amazonaws.com/..."
  }
}
```

The Java objects for representing this JSON are as follows:

```
public class User {

    private Data data;
    private String updatedAt;

    // getters, setters and toString()
}
```

```
public class Data {  
  
    private Integer id;  
    private String email;  
  
    @JsonProperty("first_name")  
    private String firstName;  
  
    @JsonProperty("last_name")  
    private String lastName;  
  
    private String avatar;  
  
    // getters, setters and toString()  
}
```

Now, let's see how we can manipulate the JSON in requests and responses.

JSON response to User

The following solution triggers a GET request and converts the returned JSON response into User:

```
Jsonb jsonb = JsonbBuilder.create();  
HttpClient client = HttpClient.newHttpClient();  
  
HttpRequest requestGet = HttpRequest.newBuilder()  
    .uri(URI.create("https://reqres.in/api/users/2"))  
    .build();  
  
HttpResponse<User> responseGet = client.send(  
    requestGet, JsonBodyHandler.jsonBodyHandler(jsonb, User.class));  
  
User user = responseGet.body();
```

Updated User to JSON request

The following solution updates the email address of the user we fetched in the preceding subsection:

```
user.getData().setEmail("newemail@gmail.com");  
  
HttpRequest requestPut = HttpRequest.newBuilder()  
    .header("Content-Type", "application/json")  
    .uri(URI.create("https://reqres.in/api/users"))
```

```
.PUT(HttpRequest.BodyPublishers.ofString(jsonb.toJson(user)))
    .build());

HttpResponse<User> responsePut = client.send(
    requestPut, JsonBodyHandler.jsonBodyHandler(jsonb, User.class));

User updatedUser = responsePut.body();
```

New User to JSON request

The following solution creates a new user (the response status code should be 201):

```
Data data = new Data();
data.setId(10);
data.setFirstName("John");
data.setLastName("Year");
data.setAvatar("https://johnyear.com/jy.png");

User newUser = new User();
newUser.setData(data);

HttpRequest requestPost = HttpRequest.newBuilder()
    .header("Content-Type", "application/json")
    .uri(URI.create("https://reqres.in/api/users"))
    .POST(HttpRequest.BodyPublishers.ofString(jsonb.toJson(user)))
    .build();

HttpResponse<Void> responsePost = client.send(
    requestPost, HttpResponse.BodyHandlers.discarding());

int sc = responsePost.statusCode(); // 201
```

Note that we ignore any response body via `HttpResponse.BodyHandlers.discarding()`.

264. Compression

Enabling `.gzip` compression on the server is a common practice that's meant to significantly improve the site's load time. But JDK 11's HTTP Client API doesn't take advantage of `.gzip` compression. In other words, the HTTP Client API doesn't require compressed responses and doesn't know how to deal with such responses.

To request compressed responses, we have to send the `Accept-Encoding` header with the `.gzip` value. This header is not added by the HTTP Client API, so we will add it as follows:

```
HttpClient client = HttpClient.newHttpClient();

HttpRequest request = HttpRequest.newBuilder()
    .header("Accept-Encoding", "gzip")
    .uri(URI.create("https://davidwalsh.name"))
    .build();
```

This is just half of the job. So far, if the `gzip` encoding is enabled on the server, then we will receive a compressed response. To detect whether the response is compressed or not, we have to check the `Encoding` header, as follows:

```
HttpResponse<InputStream> response = client.send(
    request, HttpResponse.BodyHandlers.ofInputStream());

String encoding = response.headers()
    .firstValue("Content-Encoding").orElse("");

if ("gzip".equals(encoding)) {
    String gzipAsString = gzipToString(response.body());
    System.out.println(gzipAsString);
} else {
    String isAsString = isToString(response.body());
    System.out.println(isAsString);
}
```

The `gzipToString()` method is a helper method that takes `InputStream` and treats it as `GZIPInputStream`. In other words, this method reads the bytes from the given input stream and uses them to create a string:

```
public static String gzipToString(InputStream gzip)
    throws IOException {

    byte[] allBytes;
    try (InputStream fromIs = new GZIPInputStream(gzip)) {
        allBytes = fromIs.readAllBytes();
    }

    return new String(allBytes, StandardCharsets.UTF_8);
}
```

If the response is not compressed, then `isToString()` is the helper method that we need:

```
public static String isToString(InputStream is) throws IOException {  
  
    byte[] allBytes;  
    try (InputStream fromIs = is) {  
        allBytes = fromIs.readAllBytes();  
    }  
  
    return new String(allBytes, StandardCharsets.UTF_8);  
}
```

265. Handling form data

JDK 11's HTTP Client API doesn't come with built-in support for triggering `POST` requests with `x-www-form-urlencoded`. The solution to this problem is to rely on a custom `BodyPublisher` class.

Writing a custom `BodyPublisher` class is pretty simple if we consider the following:

- Data is represented as key-value pairs
- Each pair is a `key = value` type
- Pairs are separated via the `&` character
- Keys and values should be properly encoded

Since data is represented as key-value pairs, it's very convenient to store in `Map`. Furthermore, we just loop this `Map` and apply the preceding information, as follows:

```
public class FormBodyPublisher {  
  
    public static HttpRequest.BodyPublisher ofForm(  
        Map<Object, Object> data) {  
  
        StringBuilder body = new StringBuilder();  
  
        for (Object dataKey: data.keySet()) {  
            if (body.length() > 0) {  
                body.append("&");  
            }  
  
            body.append(encode(dataKey))  
                .append("=")  
                .append(encode(data.get(dataKey)));  
        }  
    }  
}
```

```
    }

    return HttpRequest.BodyPublishers.ofString(body.toString());
}

private static String encode(Object obj) {
    return URLEncoder.encode(obj.toString(), StandardCharsets.UTF_8);
}
}
```

Relying on this solution, a POST (`x-www-form-urlencoded`) request can be triggered as follows:

```
Map<Object, Object> data = new HashMap<>();
data.put("firstname", "John");
data.put("lastname", "Year");
data.put("age", 54);
data.put("avatar", "https://avatars.com/johnyear");

HttpClient client = HttpClient.newHttpClient();

HttpRequest request = HttpRequest.newBuilder()
    .header("Content-Type", "application/x-www-form-urlencoded")
    .uri(URI.create("http://jkorpela.fi/cgi-bin/echo.cgi"))
    .POST(FormBodyPublisher.ofForm(data))
    .build();

HttpResponse<String> response = client.send(
    request, HttpResponse.BodyHandlers.ofString());
```

In this case, the response is just an echo of the sent data. Depending on the server's response, the application needs to deal with it, as shown in the *Handling response body types* section.

266. Downloading a resource

As we saw in the *Setting a request body* and *Handling response body types* sections, the HTTP Client API can send and receive text and binary data (for example, images, videos, and so on).

Downloading a file relies on the following two coordinates:

- Sending a GET request
- Handling the received bytes (for example, via `BodyHandlers.ofFile()`)

The following code downloads `hibernate-core-5.4.2.Final.jar` from the Maven repository in the project classpath:

```
HttpClient client = HttpClient.newHttpClient();

HttpRequest request = HttpRequest.newBuilder()
    .uri(URI.create("http://.../hibernate-core-5.4.2.Final.jar"))
    .build();

HttpResponse<Path> response
    = client.send(request, HttpResponse.BodyHandlers.ofFile(
        Path.of("hibernate-core-5.4.2.Final.jar")));
```

If the resource to download is delivered via the `Content-Disposition HTTP` header, which is of the `Content-Disposition attachment; filename="..."` type, then we can rely on `BodyHandlers.ofFileDownload()`, as in the following example:

```
import static java.nio.file.StandardOpenOption.CREATE;
...
HttpClient client = HttpClient.newHttpClient();

HttpRequest request = HttpRequest.newBuilder()
    .uri(URI.create("http://...downloadfile.php
        ?file=Hello.txt&cd=attachment+filename"))
    .build();

HttpResponse<Path> response = client.send(request,
    HttpResponse.BodyHandlers.ofFileDownload(Path.of(
        System.getProperty("user.dir")), CREATE));
```

More files that can be tested are available here: http://demo.borland.com/testsite/download_testpage.php.

267. Uploading with multipart

As we saw in the *Setting a request body* section, we can send a file (text or binary) to the server via `BodyPublishers.ofFile()` and a POST request.

But sending a classical upload request may involve a multipart form POST with `Content-Type` as `multipart/form-data`.

In this case, the request body is made of parts that are delimited by a boundary, as shown in the following illustration (`--779d334bbfa...` is the boundary):

```

--779d334bbfa749fdb1f4d115cd18a0cd
Content-Disposition: form-data; name="author"

Lorem Ipsum Generator
--779d334bbfa749fdb1f4d115cd18a0cd
Content-Disposition: form-data; name="filefield"; filename="figure.png"
Content-Type: image/png

%PNG
- 0æ™>iia- 8 -ò }Ÿ>)wð{púó °Ÿç÷Kt İ| °ç İ Øå™>ió½}'úÚ SÁhOcaú~ç ¾o9Û÷:ß:ë÷, '
'Ó 4V>çØ/th^\\eε! Ä úĐİÑ `Ÿİ} Bý «"è iaQ_Q »{«á i,>Y_O )yàLeÉÁ|@#+N ¼4 ô}'V|eú
Ê >à> Ö;+?Q~æg<t_çªçç ôf* Êç0ðIóóSÛ äÿ Vx#^^03çm ~ú9~ç(W·Û
zı äà°Á ä rŸR ^ TÉ«øŸô}§p .c· O"-
--779d334bbfa749fdb1f4d115cd18a0cd--

```

} part 1
} part 2

However, JDK 11's HTTP Client API doesn't provide built-in support for building this kind of request body. Nevertheless, by following the preceding screenshot, we can define a custom `BodyPublisher` as follows:

```

public class MultipartBodyPublisher {

    private static final String LINE_SEPARATOR = System.lineSeparator();

    public static HttpRequest.BodyPublisher ofMultipart(
        Map<Object, Object> data, String boundary) throws IOException {

        final byte[] separator = ("--" + boundary +
            LINE_SEPARATOR + "Content-Disposition: form-data;
            name = ").getBytes(StandardCharsets.UTF_8);

        final List<byte[] > body = new ArrayList<>();

        for (Object dataKey: data.keySet()) {

            body.add(separator);
            Object dataValue = data.get(dataKey);

            if (dataValue instanceof Path) {
                Path path = (Path) dataValue;
                String mimeType = fetchMimeType(path);

                body.add(("\" + dataKey + "\"; filename=\"" +

```

```

        path.getFileName() + "\" + LINE_SEPARATOR +
        "Content-Type: " + mimeType + LINE_SEPARATOR +
        LINE_SEPARATOR).getBytes(StandardCharsets.UTF_8));

        body.add(Files.readAllBytes(path));
        body.add(LINE_SEPARATOR.getBytes(StandardCharsets.UTF_8));
    } else {
        body.add(("\" + dataKey + "\" + LINE_SEPARATOR +
            LINE_SEPARATOR + dataValue + LINE_SEPARATOR)
            .getBytes(StandardCharsets.UTF_8));
    }
}

body.add(("--" + boundary
    + "--").getBytes(StandardCharsets.UTF_8));

return HttpRequest.BodyPublishers.ofByteArrays(body);
}

private static String fetchMimeType(
    Path filenamePath) throws IOException {

    String mimeType = Files.probeContentType(filenamePath);

    if (mimeType == null) {
        throw new IOException("Mime type could not be fetched");
    }

    return mimeType;
}
}

```

Now, we can create a multipart request, as follows (we try to upload a text file called `LoremIpsum.txt` to a server that simply sent back the raw form data):

```

Map<Object, Object> data = new LinkedHashMap<>();
data.put("author", "Lorem Ipsum Generator");
data.put("filefield", Path.of("LoremIpsum.txt"));

String boundary = UUID.randomUUID().toString().replaceAll("-", "");

HttpClient client = HttpClient.newHttpClient();

HttpRequest request = HttpRequest.newBuilder()
    .header("Content-Type", "multipart/form-data;boundary=" + boundary)
    .POST(MultipartBodyPublisher.ofMultipart(data, boundary))
    .uri(URI.create("http://jcorpela.fi/cgi-bin/echoraw.cgi"))
    .build();

```

```
HttpResponse<String> response = client.send(
    request, HttpResponse.BodyHandlers.ofString());
```

The response should be similar to the following (the boundary is just a random UUID):

```
--7ea7a8311ada4804ab11d29bcdedcc55
Content-Disposition: form-data; name="author"
Lorem Ipsum Generator
--7ea7a8311ada4804ab11d29bcdedcc55
Content-Disposition: form-data; name="filefield";
filename="LoremIpsum.txt"
Content-Type: text/plain
Lorem ipsum dolor sit amet, consectetur adipiscing elit, sed do
eiusmod tempor incididunt ut labore et dolore magna aliqua.
--7ea7a8311ada4804ab11d29bcdedcc55--
```

268. HTTP/2 server push

Besides *multiplexing*, another powerful feature of HTTP/2 is its *server push* capability.

Mainly, in the traditional approach (HTTP/1.1), a browser triggers a request for getting an HTML page and parses the received markup to identify the referenced resources (for example, JS, CSS, images, and so on). To fetch these resources, the browser sends additional requests (one request for each referenced resource). On the other hand, HTTP/2 sends the HTML page and the referenced resources without explicit requests from the browser. So, the browser requests the HTML page and receives the page and everything else that's needed for displaying the page.

The HTTP Client API supports this HTTP/2 feature via the `PushPromiseHandler` interface. The implementation of this interface must be given as the third argument of the `send()` or `sendAsync()` method.

`PushPromiseHandler` relies on three coordinates, as follows:

- The initiating client send request (`initiatingRequest`)
- The synthetic push request (`pushPromiseRequest`)
- The acceptor function, which must be successfully invoked to accept the push promise (acceptor)

A push promise is accepted by invoking the given acceptor function. The acceptor function must be passed a non-null `BodyHandler`, which is used to handle the promise's response body. The acceptor function will return a `CompletableFuture` instance that completes the promise's response.

Based on this information, let's look at an implementation of `PushPromiseHandler`:

```
private static final List<CompletableFuture<Void>>
    asyncPushRequests = new CopyOnWriteArrayList<>();
...
private static HttpResponse.PushPromiseHandler<String>
    pushPromiseHandler() {

    return (HttpRequest initiatingRequest,
        HttpRequest pushPromiseRequest,
        Function<HttpResponse.BodyHandler<String> ,
        CompletableFuture<HttpResponse<String>>> acceptor) -> {
        CompletableFuture<Void> pushcf =
            acceptor.apply(HttpResponse.BodyHandlers.ofString())
                .thenApply(HttpResponse::body)
                .thenAccept((b) -> System.out.println(
                    "\nPushed resource body:\n " + b));

        asyncPushRequests.add(pushcf);

        System.out.println("\nJust got promise push number: " +
            asyncPushRequests.size());
        System.out.println("\nInitial push request: " +
            initiatingRequest.uri());
        System.out.println("Initial push headers: " +
            initiatingRequest.headers());
        System.out.println("Promise push request: " +
            pushPromiseRequest.uri());
        System.out.println("Promise push headers: " +
            pushPromiseRequest.headers());
    };
}
```

Now, let's trigger a request and pass this `PushPromiseHandler` to `sendAsync()`:

```
HttpClient client = HttpClient.newHttpClient();

HttpRequest request = HttpRequest.newBuilder()
    .uri(URI.create("https://http2.golang.org/serverpush"))
    .build();

client.sendAsync(request,
    HttpResponse.BodyHandlers.ofString(), pushPromiseHandler())
    .thenApply(HttpResponse::body)
    .thenAccept((b) -> System.out.println("\nMain resource:\n" + b))
    .join();

asyncPushRequests.forEach(CompletableFuture::join);
```

```
System.out.println("\nFetched a total of " +
    asyncPushRequests.size() + " push requests");
```

If we want to return a push promise handler that accumulates push promises, and their responses, into the given map, then we can rely on the `PushPromiseHandler.of()` method, as follows:

```
private static final ConcurrentMap<HttpRequest,
    CompletableFuture<HttpResponse<String>>> promisesMap
    = new ConcurrentHashMap<>();

private static final Function<HttpRequest,
    HttpResponse.BodyHandler<String>> promiseHandler
    = (HttpRequest req) -> HttpResponse.BodyHandlers.ofString();

public static void main(String[] args)
    throws IOException, InterruptedException {

    HttpClient client = HttpClient.newHttpClient();

    HttpRequest request = HttpRequest.newBuilder()
        .uri(URI.create("https://http2.golang.org/serverpush"))
        .build();

    client.sendAsync(request,
        HttpResponse.BodyHandlers.ofString(), pushPromiseHandler())
        .thenApply(HttpResponse::body)
        .thenAccept((b) -> System.out.println("\nMain resource:\n" + b))
        .join();

    System.out.println("\nPush promises map size: " +
        promisesMap.size() + "\n");

    promisesMap.entrySet().forEach((entry) -> {
        System.out.println("Request = " + entry.getKey() +
            ", \nResponse = " + entry.getValue().join().body());
    });
}

private static HttpResponse.PushPromiseHandler<String>
    pushPromiseHandler() {

    return HttpResponse.PushPromiseHandler
        .of(promiseHandler, promisesMap);
}
```

In both solutions of the preceding solutions, we have used a `BodyHandler` of the `String` type via `ofString()`. This is not very useful if the server pushes binary data as well (for example, images). So, if we are dealing with binary data, we need to switch to `BodyHandler` of the `byte[]` type via `ofByteArray()`. Alternatively, we can send the pushed resources to disk via `ofFile()`, as shown in the following solution, which is an adapted version of the preceding solution:

```
private static final ConcurrentMap<HttpRequest,
    CompletableFuture<HttpResponse<Path>>>
    promisesMap = new ConcurrentHashMap<>();

private static final Function<HttpRequest,
    HttpResponse.BodyHandler<Path>> promiseHandler
    = (HttpRequest req) -> HttpResponse.BodyHandlers.ofFile(
        Paths.get(req.uri().getPath()).getFileName());

public static void main(String[] args)
    throws IOException, InterruptedException {

    HttpClient client = HttpClient.newHttpClient();

    HttpRequest request = HttpRequest.newBuilder()
        .uri(URI.create("https://http2.golang.org/serverpush"))
        .build();

    client.sendAsync(request, HttpResponse.BodyHandlers.ofFile(
        Path.of("index.html")), pushPromiseHandler())
        .thenApply(HttpResponse::body)
        .thenAccept((b) -> System.out.println("\nMain resource:\n" + b))
        .join();





    System.out.println("\nPush promises map size: " +
        promisesMap.size() + "\n");

    promisesMap.entrySet().forEach((entry) -> {
        System.out.println("Request = " + entry.getKey() +
            ", \nResponse = " + entry.getValue().join().body());
    });
}

private static HttpResponse.PushPromiseHandler<Path>
    pushPromiseHandler() {

    return HttpResponse.PushPromiseHandler
        .of(promiseHandler, promisesMap);
}
```

The preceding code should save the pushed resources in the application classpath, as shown in the following screenshot:

 godocs	5/16/2019 10:26 AM	JScript Script File	18 KB
 index	5/16/2019 10:26 AM	Chrome HTML Do...	66 KB
 jquery.min	5/16/2019 10:26 AM	JScript Script File	92 KB
 playground	5/16/2019 10:26 AM	JScript Script File	15 KB
 style	5/16/2019 10:26 AM	Cascading Style S...	14 KB

269. WebSocket

The HTTP Client supports the WebSocket protocol. In API terms, the core of the implementation is the `java.net.http.WebSocket` interface. This interface exposes a suite of methods for handling WebSocket communication.

Building a `WebSocket` instance asynchronously can be accomplished via `HttpClient.newWebSocketBuilder().buildAsync()`.

For example, we can connect to the well known Meetup RSVP WebSocket endpoint (`ws://stream.meetup.com/2/rsvps`), as follows:

```
HttpClient client = HttpClient.newHttpClient();

WebSocket websocket = client.newWebSocketBuilder()
    .buildAsync(URI.create("ws://stream.meetup.com/2/rsvps"),
        wsListener).get(10, TimeUnit.SECONDS);
```

By its nature, the WebSocket protocol is bidirectional. In order to send data, we can rely on `sendText()`, `sendBinary()`, `sendPing()`, and `sendPong()`. The Meetup RSVP doesn't process the messages that we send but, just for fun, we can send a text message, as follows:

```
websocket.sendText("I am an Meetup RSVP fan", true);
```

The `boolean` argument is used to mark the end of the message. If this invocation doesn't complete, the message passes `false`.

To close the connection, we need to use `sendClose()`, as follows:

```
websocket.sendClose(WebSocket.NORMAL_CLOSURE, "ok");
```

Finally, we need to write the `WebSocket.Listener` that will process the incoming messages. This is an interface that contains a bunch of methods with default implementations. The following code simply overrides `onOpen()`, `onText()`, and `onClose()`. Gluing the `WebSocket` listener and the preceding code will result in the following application:

```
public class Main {

    public static void main(String[] args) throws
        InterruptedException, ExecutionException, TimeoutException {

        Listener wsListener = new Listener() {

            @Override
            public CompletionStage<?> onText(WebSocket websocket,
                CharSequence data, boolean last) {
                System.out.println("Received data: " + data);

                return Listener.super.onText(websocket, data, last);
            }

            @Override
            public void onOpen(WebSocket websocket) {
                System.out.println("Connection is open ...");
                Listener.super.onOpen(websocket);
            }

            @Override
            public CompletionStage<?> onClose(WebSocket websocket,
                int statusCode, String reason) {
                System.out.println("Closing connection: " +
                    statusCode + " " + reason);

                return Listener.super.onClose(websocket, statusCode, reason);
            }
        };

        HttpClient client = HttpClient.newHttpClient();

        WebSocket websocket = client.newWebSocketBuilder()
            .buildAsync(URI.create(
                "ws://stream.meetup.com/2/rsvps"), wsListener)
            .get(10, TimeUnit.SECONDS);
```



```
        TimeUnit.SECONDS.sleep(10);

        websocket.sendClose(WebSocket.NORMAL_CLOSURE, "ok");
    }
}
```

This application will run for 10 seconds and will produce output similar to the following:

```
Connection is open ...
```

```
Received data:
```

```
{"visibility":"public","response":"yes","guests":0,"member":{"member_id":267133566,"photo":"https://secure.meetupstatic.com/photos/membr\8\7\8\8\a/thumb_282154698.jpeg","member_name":"SANDRA MARTINEZ"},"rsvp_id":1781366945...
```

```
Received data:
```

```
{"visibility":"public","response":"yes","guests":1,"member":{"member_id":51797722,...
```

```
...
```

After 10 seconds, the application is disconnected from the WebSocket endpoint.

Summary

Our job is done! This was the last problem in this chapter. Now, we have reached the end of this book. It looks like the new HTTP Client and WebSocket APIs are pretty cool. They come with substantial flexibility and versatility, they are pretty intuitive, and they manage to successfully hide a lot of painful details that we don't want to deal with during development.

Download the applications from this chapter to view the results and additional details.

Other Books You May Enjoy

If you enjoyed this book, you may be interested in these other books by Packt:

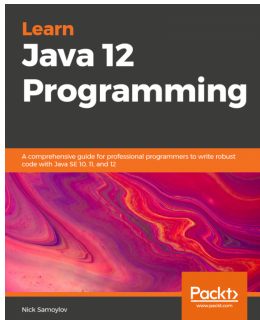

Learn Java 12 Programming

Nick Samoylov

ISBN: 978-1-78995-705-1

- Learn and apply object-oriented principles
- Gain insights into data structures and understand how they are used in Java
- Explore multithreaded, asynchronous, functional, and reactive programming
- Add a user-friendly graphic interface to your application
- Find out what streams are and how they can help in data processing
- Discover the importance of microservices and use them to make your apps robust and scalable
- Explore Java design patterns and best practices to solve everyday problems
- Learn techniques and idioms for writing high-quality Java code



Java 11 and 12 - New Features

Mala Gupta

ISBN: 978-1-78913-327-1

- Study type interference and how to work with the var type
- Understand Class-Data Sharing, its benefits, and limitations
- Discover platform options to reduce your application's launch time
- Improve application performance by switching garbage collectors
- Get up to date with the new Java release cadence
- Define and assess decision criteria for migrating to a new version of Java

Leave a review - let other readers know what you think

Please share your thoughts on this book with others by leaving a review on the site that you bought it from. If you purchased the book from Amazon, please leave us an honest review on this book's Amazon page. This is vital so that other potential readers can see and use your unbiased opinion to make purchasing decisions, we can understand what our customers think about our products, and our authors can see your feedback on the title that they have worked with Packt to create. It will only take a few minutes of your time, but is valuable to other potential customers, our authors, and Packt. Thank you!

Index

A

- absolute path
 - creating 301
- accessors 406
- accumulator() method 541
- age
 - calculating 158
 - calculating, with Calendar 158
 - calculating, with Period class 158
 - calculating, with SimpleDateFormat 158
- annotation
 - obtaining, of receiver type 398
- array
 - assigning, to var 183
 - average value, computing 228, 231, 232
 - collection, converting into 265
 - component type, obtaining 392
 - element, finding 215
 - equal, checking 220, 221, 222
 - filling 234, 235
 - JDK built-in solutions 201, 202, 203
 - lexicographic comparison 224, 225, 226
 - maximum value, computing 228, 229, 230
 - minimum value, computing 228, 229, 230
 - mismatch, checking 220, 222, 223
 - reversing 232, 233
 - setting 234, 235
 - size, changing 237, 238
 - solutions 201
 - sorting 201
 - sorting algorithms 204
 - sorting, of string by length 36, 37
 - stream, creating 227, 228
 - testing, problems used 199, 200
 - working with 429
- Arrays.asList() method 240

- asynchronous GET request

 - triggering 738, 739, 740

- atomic variables

 - about 682, 683, 684, 685

 - accumulators 685, 686

 - adders 685, 686

B

- bad data

 - avoiding, in immutable objects 103, 105

- barrier 616, 617, 619, 620

- Behavior Parameterization 441

- big files

 - occurrence of string, searching in 338

 - solution, based on Files.lines() 340

 - solution, searching based on BufferedReader 339

 - solution, searching based on

 - Files.readAllLines() 339

 - solution, searching based on

 - MappedByteBuffer 341, 342

 - solution, searching based on Scanner 340

- BigInteger

 - converting, into primitive type 58

- binary files

 - reading, efficiently 333, 334, 335

 - reading, into memory 336

 - writing 337, 338

 - writing, efficiently 333, 334, 335

- Binary Indexed Tree (BIT) 289, 290, 291, 292, 293

- Binary Search 46

- Bloom filter 293, 294, 295

- boolean

 - returning, if Optional class is empty 733

- breadth-first search (BFS)

 - about 275, 276, 277

- algorithm 276, 277
- pseudo-code 275
- bridge constructs
 - obtaining 399, 400
- bubble sort algorithm 204, 205, 206
- BufferedReader
 - versus Scanner 378
- Builder pattern
 - immutable class, writing via 100
- busy waiting technique
 - optimizing 674, 675
- byte buffer
 - implementing 358, 359, 360, 361, 362, 363, 364, 366

C

- Callable 604, 605, 606, 607, 608
- Callable tasks
 - invoking 610, 611, 612
- Cascaded Builder pattern
 - implementing 466, 467
- character
 - removing 32, 33
- characteristics() method 543
- chess clock
 - implementing 164, 165, 166, 168, 169
- Chinese, Japanese, Korean, and Vietnamese (CJKV) 553
- circular wait 697
- class annotations
 - inspecting 415
- class-level locking
 - about 574
 - versus object-level locking 573
- clone()
 - objects, cloning via 106
- Cloning library
 - objects, cloning via 108
 - reference link 260
- collection
 - converting, into array 265
 - filtering, by List 265, 266, 267
 - solutions 201
 - testing, problems used 199, 200
- Collections.unmodifiableList() method 239,
 - 240, 242, 243, 244
- combiner() method 542
- Command pattern
 - implementing 467, 468, 470
- compact number
 - formatting 65, 67, 68
 - parsing 68, 69
- comparators
 - composing 558, 559, 560
- Compare and Swap (CAS) 683
- compareAndSetForkJoinTaskTag() 648, 649, 650, 651
- comparisons
 - counting 20
- CompletableFuture
 - about 651
 - asynchronous task, running and results
 - returning 653
 - asynchronous task, running and results
 - returning via explicit thread pool 653
 - asynchronous task, running and void
 - returning 652
 - callback, attaching that process result of asynchronous task and return result 654, 655
 - callback, attaching that processes result of asynchronous task and returns void 656
 - callback, attaching that runs after asynchronous task and returns void 657
 - exceptions, handling of asynchronous task via
 - exceptionally() 658, 659, 660, 661, 663, 664
 - exceptions, handling of asynchronous task via
 - handle() 665, 666
 - explicitly, completing 667, 668
 - JDK 12 exceptionallyCompose() 664, 665
 - merging 668
 - merging, via allOf() 671, 672
 - merging, via anyOf() 672, 673
 - merging, via thenCombine() 670, 671
 - merging, via thenCompose() 668, 669
- compression 760, 761
- concurrency
 - issues 634, 635
 - solutions 635

- connection authentication
 - setting 747, 748
- consonants
 - counting 19, 21
- constructor
 - objects, cloning via 107
- contravariants
 - replacing, with Local Variable Type Inference (LVTI) 197, 198
- cookies
 - handling 753, 754
- CountedCompleter
 - using 645, 647
- counting sort algorithm 209, 210
- covariants
 - replacing, with Local Variable Type Inference (LVTI) 197, 198
- Cross Cutting-Concerns (CCC) 432
- CSV file
 - reading, as object 342, 346, 347
- custom collector
 - via collect() 544
 - writing 538, 540
- custom Spliterator
 - writing 553

D

- data structures
 - solutions 201
 - testing, problems used 199, 200
- date and time, testing problems
 - reference link 120
- date and time
 - formatting 124, 125, 126, 127
 - obtaining, via LocalDate 128
 - obtaining, via LocalTime 128
 - obtaining, without date or time 128
 - string, converting to 120
 - string, converting with DateFormat class 120
 - string, converting with DateTimeFormatter class 120, 121, 122, 124
 - testing, problems used 118, 120
 - units, obtaining 137, 138
- Date object
 - converting, to DateLocalTime 154

- converting, to Instant 152, 153
- converting, to LocalDate 153
- converting, to LocalTime 155
- converting, to OffsetDateTime 155
- converting, to OffsetTime 156
- converting, to Temporal 151
- converting, to ZonedDateTime 154
- date-based values
 - used, for defining period of time 132
- date-time information
 - displaying, of flight 144, 145
 - representing, via Calendar class 162
 - representing, via java.util.Date class 162
 - representing, via Temporal 162, 163, 164
- date-time
 - Date object, working with 139
 - LocalDateTime, working with 139, 140
 - time, adding to 138
 - time, subtracting from 138
 - Unix timestamp, converting to 145, 146
- dates
 - defining, as LocalDate class 157
 - difference, computing between 162
 - range, iterating 156
 - range, iterating with
 - LocalDate.datesUntil(LocalDate endExclusive) method 157
 - ranges, iterating, with Calendar class 156
- deadlock 697, 698, 699, 700
- declared annotation
 - obtaining 421
- Decorator pattern
 - implementing 462, 463, 464, 465, 466
- default methods 562, 563
- default value
 - mapping 245
- delimiter
 - string, joining with 24, 25
- digital tree 277
- division
 - floor, computing 60, 61
 - of unsigned values 55
- double/float 56
- dropWhile() 484, 485
- dropWhile(Predicate) methods

- using 491, 492, 493
- duplicate characters
 - counting 11, 12
 - removing 30, 31
- duration class 134
- duration, of time
 - defining, with time-based values 132, 134, 135, 136, 137
- dynamic proxies
 - about 432, 433
 - implementing 433, 435, 436

E

- element
 - finding, in array 215
 - first index, checking 219, 220
 - matching, in stream 503, 504
 - presence, checking 215, 216, 217, 218
 - removing, of collection 262
 - removing, via `Collection.removeIf()` 263
 - removing, via iterator 263
 - removing, via `Stream` 263, 264
 - replacing, of `List` 267, 268
 - separating, via `Collectors.partitioningBy()` 264
- elements, grouping of stream
 - about 518
 - multilevel grouping 526, 527, 528
 - single-level grouping 519, 520, 521, 522, 523, 524, 525, 526
- elements, mapping of stream
 - about 493
 - `Stream.flatMap()`, using 497, 498, 499, 500
 - `Stream.map()`, using 494, 495, 496
- elements, searching in stream
 - about 500
 - `findAny()` method, using 501
 - `findFirst()`, using 501, 502
- end of day
 - searching 159, 160, 161
- `equals()` method 85, 86, 87, 89, 90
- exceptions
 - generic, obtaining 424, 427, 428
- exchanger 621, 622, 623, 624
- Execute Around pattern
 - implementing 448, 450

F

- Factory pattern
 - implementing 450, 451, 452
- Fenwick Tree (FT) 289, 290, 291, 292, 293
- Fibonacci
 - computing, via `RecursiveAction` 643, 645
- fields
 - annotations, inspecting 419
 - generic, obtaining 424, 426
- file paths
 - comparing 307
 - comparing, with `Path.equals()` 308
 - constructing, between two locations 306, 307
 - converting 303, 304, 305
 - creating 299, 300
 - creating, to current folder 301
 - creating, to file store root 300
 - creating, with shortcuts 302, 303
 - joining 305, 306
 - lexicographical comparison 309
 - partial comparing 309
 - representing, same file/folder 308
- file's content
 - streaming 323
- files
 - filtering 352
 - filtering, via `FileFilter` 355
 - filtering, via `FilenameFilter` 355
 - filtering, via `Files.newDirectoryStream()` 352, 353, 354
 - formatted output, writing 371, 372, 373
 - mismatches, discovering 356, 357
 - searching, in file trees 324, 325, 326
 - tokenizing 366, 367, 368, 369, 370, 371
- FileVisitor
 - methods 310
- `filtering()`
 - using 532, 533
- find operation
 - implementing 287
- `finisher()` method 542, 543
- first day of month
 - finding 149

- searching 146
- First In First Out (FIFO) 271, 583
- first non-repeated character
 - searching 14, 15, 16, 17
- flatMapping()
 - using 534, 535
- folders
 - searching, in file tree 326
 - searching, in file trees 324, 325
- fork/join framework 639, 640, 641, 648, 649, 650, 651
- form data
 - handling 762, 763
- format patterns 124
- functional interfaces
 - anonymous classes, written as lambdas 444
 - behavior, pushing as parameter 441, 442, 443
 - filters, implementing 443
 - List type, abstracting 445, 446
 - melons, filtering by type 439, 440
 - melons, filtering by weight 440
 - melons, filtering of certain weight 440
 - writing 438
- functional-style code
 - null references, checking in 72, 73, 75
- functional-style programming
 - issues 472, 473
 - solutions 438, 474
- functions
 - composing 560, 562
- Fused Multiply Add 64, 65
- Future
 - about 604, 605, 606, 607, 608
 - canceling 609, 610

G

- Gang of Four (GoF) 100
- getters
 - fetching 407, 408, 409
 - generating 409, 411, 412, 413
- GMT
 - about 140
 - used, for obtaining time zones 140
- Gson

- using 346

H

- hashCode() method 85, 86, 87, 89, 90
- HashMap
 - copying 259, 260
- headers
 - obtaining 741
 - setting 741
- heap sort algorithm 210, 211, 213, 214
- high-order functions
 - method, testing that returns a functional interface 475
 - method, testing that takes lambda as a parameter 474, 475
 - testing 474
- High-Performance Computing (HPC) 64
- HTTP Client
 - issues 735, 736
 - solutions 737
- HTTP method
 - specifying 744, 745
- HTTP/2 737, 738
- HTTP/2 server push 767, 768, 770, 771

I

- identity-sensitive operations 731, 732
- immutable class
 - mutable objects, passing to 97, 99, 100
 - mutable objects, returning from 97, 99, 100
 - writing 96
 - writing, via Builder pattern 100
- immutable collections
 - about 240
 - Arrays.asList() method 240
 - Collections.unmodifiableList() method 240, 242, 243, 244
 - creating 238, 239
 - List.of() method 241, 242, 243, 244
 - static block 241
- immutable objects
 - about 91
 - bad data, avoiding in 103, 105
- imperative code
 - null references, checking in 72, 73, 75

- indentation
 - applying 47, 48
- index
 - checking, in range from 0 to length 80, 81, 82
- infinite sequential ordered stream
 - obtaining 485, 486, 487
- infinite sequential unordered stream
 - creating 489
- infinite streams 484, 485
- insertion sort algorithm 206, 207, 208
- instance method
 - invoking 421, 422
- Instant class
 - about 129
 - used, for generating timestamps of machine time 129
- Instant objects
 - comparing 130
- Instant
 - converting, to LocalDateTime 131
 - converting, to OffsetDateTime 131
 - converting, to ZonedDateTime 131
 - string, converting to 130
 - time, adding to 130
 - time, subtracting from 130
- int value
 - long value, converting into 59
 - multiplying 62, 64
 - summing 51, 52
- interfaces
 - annotations, inspecting 420
 - generic, obtaining 427
- interruptible methods 636, 637, 638, 639

J

- Jackson
 - using 344, 345
- JAR
 - class, instantiating from 396, 397
- Java concurrency
 - issues 564, 565
 - solutions 566
- Java I/O
 - issues 297, 298
 - solutions 299
- Java Reflection API, solutions
 - annotation, obtaining of receiver type 398
 - bridge constructs, obtaining 399, 400
 - classes, inspecting 386
 - default methods, checking 402
 - for getters 406
 - for setters 406
 - nest-based access control (nests) via 402, 403, 404, 406
 - packages, inspecting 381, 382
 - synthetic constructs, obtaining 399, 400
 - used, for instantiating class via reflected constructor 393, 394
 - variable number, checking of arguments 401
- Java Reflection API
 - annotations 414
 - annotations, inspecting of fields 419
 - annotations, inspecting of interfaces 420
 - annotations, inspecting of method's parameters 418
 - annotations, inspecting of return type 417
 - annotations, inspecting of superclass 419
 - annotations, inspecting of thrown exceptions 417
 - annotations, obtaining by type 421
 - class annotations, inspecting 415
 - declared annotation, obtaining 421
 - dynamic proxies 432, 433
 - instance method, invoking 421, 422
 - methods annotations, inspecting 416
 - modules, inspecting 430, 431
 - package annotations, inspecting 415
 - private fields, obtaining 428
 - problem 379, 380
 - public fields, obtaining 428
 - snippets, of code 397
 - solutions 381
 - static methods, obtaining 422, 424
 - used, for instantiating class from JAR 396, 397
 - used, for instantiating class via private constructor 395
 - used, for obtaining class of array type whose component type is described by Pair 393

- used, for obtaining component type of array 392
- used, for obtaining name of certain type 390
- used, for obtaining Pair class constructors 388
- used, for obtaining Pair class fields 388
- used, for obtaining Pair class implemented interfaces 387
- used, for obtaining Pair class methods 389
- used, for obtaining Pair class modifiers 387
- used, for obtaining Pair class module 390
- used, for obtaining Pair class super-class 390
- used, for obtaining strings that describe class 392
- used, for obtaining type descriptor string for class 392
- using, for obtaining name of Pair class via instance 386
- working, with arrays 429
- Java thread, lifecycle states
 - about 566, 567
 - BLOCKED state 568, 569
 - NEW state 567
 - RUNNABLE state 567
 - TERMINATED state 572
 - TIMED_WAITING state 571
 - WAITING state 570
- Java, built-in concurrent collection
 - about 269
 - synchronized collection 274
 - thread-safe delay queue 272
 - thread-safe lists 269
 - thread-safe map 270
 - thread-safe priority queue 272
 - thread-safe queue, backed by array 271
 - thread-safe queue, on linked nodes 272
 - thread-safe set 270
 - thread-safe stack 273
 - thread-safe synchronous queue 273
 - thread-safe transfer queue 273
 - versus Java built-in synchronized collection 274
- JDK 8
 - using 120
- JDK 9 157
- JDK built-in solutions 201, 202, 203
- JSON file
 - reading, as object 342, 343
 - writing, as object 342, 343
- JSON request
 - new user 760
 - updated user 759
- JSON-B
 - using 343, 344
- JSON
 - objects, cloning via 110
 - obtaining 757
 - response, to user 759
 - saving 757
 - updating 757

L

- lambdas
 - about 447
 - chaining, via `orElseFoo()` 713, 714
 - debugging 478, 479, 480, 481
 - Local Variable Type Inference (LVTI), using with 193, 194
 - used, for testing methods 476, 477
- last day of month
 - searching 146, 148, 149
- Last In First Out (LIFO) 185, 273
- latches 613, 615, 616
- Least Significant Bit (LSB) 289
- letters
 - reversing 17, 18
- List.of() method 241, 242, 243, 244
- List
 - collection, filtering 265, 266, 267
 - element, replacing 267, 268
- Loan pattern
 - implementing 459, 460, 461, 462
- local date-time
 - obtaining, in all time zones 142
 - obtaining, via `Date` empty constructor 142
 - obtaining, via `ZonedDateTime.now()` method 143
- Local Variable Type Inference (LVTI)
 - about 170
 - argument types 190, 191

- avoid, using with catch block variables 195
- avoid, using with instance variables 194
- avoid, using with null initializers 194
- avoiding 178
- avoiding, if called names don't contain enough type information for humans 179, 180
- combining, with diamond operator 181, 182
- combining, with generic types T 195, 196
- combining, with implicit type casting to sustain code maintainability 176, 177, 178
- combining, with programming to interface technique 180, 181
- effectively final 192, 193
- examples 172, 173, 174
- method return types 190, 191
- try-with-resource 195
- used, for replacing contravariants 197, 198
- used, for replacing covariants 197, 198
- used, for replacing wildcards 197
- using, for anonymous classes 191, 192
- using, for loops 187, 188
- using, in compound declarations 184
- using, to break up nested/large chains of expressions 189, 190
- using, with lambdas 193, 194
- using, with primitive types 175, 176
- using, with streams 188
- using, with ternary operator 186, 187
- using, with variable scope 184, 185
- LocalDate
 - used, for obtaining LocalDateTime class 128, 129
- LocalDateTime class
 - obtaining, from LocalDate 128, 129
 - obtaining, from LocalTime 128, 129
- LocalTime
 - used, for obtaining LocalDateTime class 128, 129
- logical AND
 - applying, to two booleans 57
- logical OR
 - applying, to two booleans 57
- logical XOR
 - applying, to two booleans 57
- long value

- converting, into int value 59
- multiplying 62, 64
- summing 51, 52
- longest common prefix
 - searching 45, 46

M

- machine time
 - timestamps, generating via Instant class 129
- map
 - absent/present, computing 246
 - comparing 255, 256
 - compute() 249, 250
 - computeIfAbsent() 247, 248
 - computeIfPresent() 246, 247
 - entries, replacing 253, 254
 - merge() 250, 251
 - merging 260, 261, 262
 - natural ordering 257
 - putIfAbsent() 251, 252
 - removal 252, 253
 - sorting 256, 257
 - sorting, by key via Comparator 257, 258
 - sorting, by key via List 258
 - sorting, by key via Stream 257, 258
 - sorting, by key via TreeMap 257
 - sorting, by value via Comparator 257, 258
 - sorting, by value via List 258
 - sorting, by value via Stream 257, 258
- mapping()
 - using 533
- max() methods
 - computing, of numbers 50
 - terminal operations 505
- method references
 - about 545
 - to constructor 547
 - to instance method 546
 - to static method 545
- method's parameters
 - annotations, inspecting 418
- methods annotations
 - inspecting 416
- methods
 - generic, obtaining 424, 425, 426

- testing, with lambdas 476, 477
- min() methods
 - computing, of numbers 50
 - in stream 504
 - terminal operations 505
- modules
 - inspecting 430, 431
- modulo
 - of unsigned values 55
- modulus
 - floor, computing 60, 61
- multi-line strings
 - declaring 41, 42
- multipart
 - file, uploading with 764, 765, 766
- multiple case labels 115
- multiple requests concurrently
 - sending 752, 753
- mutable objects
 - passing, to immutable class 97, 99, 100
 - returning, from immutable class 97, 99, 100

N

- nest-based access control (nests)
 - via Java Reflection API 402, 403, 404, 406
- Next Greater Element (NGE) 236, 237
- next integer-point value 61, 62
- non-zero elements
 - filtering, of stream 482, 483, 484
- null references
 - about 709, 710
 - checking, and returning non-null default references 79, 80
 - checking, and throwing customized NullPointerException 75, 76, 77
 - checking, and throwing specified exception 77, 78, 79
 - checking, in functional-style code 72, 73, 74
 - checking, in imperative code 72, 73, 74
- null-safe streams 554, 555, 556
- numbers
 - max, computing 50
 - min, computing 50

O

- object-level locking
 - about 573
 - versus class-level locking 573
- objects
 - cloning 105
 - cloning, via clone() 106
 - cloning, via Cloning library 108
 - cloning, via constructor 107
 - cloning, via JSON 110
 - cloning, via serialization 109
 - manual cloning 105
- Observer pattern
 - implementing 456, 457, 458
- observers 456
- ofNullable()
 - Optional.of(), confusing with 724, 725
- operation overflow
 - multiplying 62, 64
 - summing 51, 52
- Optional T
 - versus OptionalInt 725
- Optional value
 - transforming, via flatMap() 727, 728
 - transforming, via Map() 727, 728
- Optional.filter()
 - using, filtering values 729
- Optional.of()
 - confusing, with ofNullable() 724, 725
- Optional
 - about 709, 710, 731, 732
 - already-constructed default value, returning 706
 - avoiding 715, 716, 718, 719, 721, 722
 - avoiding, in collections 722, 723
 - boolean, returning 733
 - chaining 730, 731
 - equality, asserting 726, 727
 - initializing 705
 - issues 702, 703, 704
 - missing value 705
 - non-existent default value, returning 707
 - NoSuchElementException, throwing 708
- optional
 - NoSuchElementException, throwing 709

- Optional
 - Optional.get() 705
 - solution 704
- OptionalInt
 - versus Optional T 725
- orElseFoo()
 - lambdas, chaining via 713, 714
- P**
- package annotations
 - inspecting 415
- packages
 - classes, obtaining 382, 383, 385
 - inspecting 381, 382
 - inspecting, inside modules 385
- Pair class constructors
 - obtaining 388
- Pair class fields
 - obtaining 388
- Pair class implemented interfaces
 - obtaining 387
- Pair class methods
 - obtaining 389
- Pair class modifiers
 - obtaining 387
- Pair class module
 - obtaining 390
- Pair class super-class
 - obtaining 390
- Pair class
 - name, obtaining via instance 386
- partitioning 528, 529, 530, 531
- Path.equals()
 - used, for comparing file paths 308
- Period class 133
- period of time
 - defining, with date-based values 132, 133, 134
- permutations
 - generating 26, 27, 28
- phasers 628, 629, 630
- Plain Old Java Object (POJO) 110
- predicates
 - about 441
 - composing 556, 557

- present Optional class
 - consuming 710, 711
 - returning 712
- private constructor
 - class, instantiating via 395
- proxy
 - setting 741
- pseudorandom values
 - unlimited streams, creating 487

Q

- query parameters builder 740

R

- range
 - iterating, of dates 156
- RecursiveAction
 - Fibonacci, computing via 643, 645
- RecursiveTask
 - sum, computing via 641, 643
- redirect policy
 - setting 749, 750
- reduction 506, 507, 508, 509
- ReentrantLock 687, 688, 689
- ReentrantReadWriteLock 690, 691, 692
- reflected constructor
 - class, instantiating via 393, 394
- request body
 - creating, from byte array 747
 - creating, from file 747
 - creating, from InputStream 746
 - creating, from string 746
 - setting 745
- request headers
 - obtaining 743
 - setting 741, 742
- request
 - sending, asynchronously 750, 751
 - sending, synchronously 751
- resource
 - downloading 763, 764
- response body types
 - handling 755
 - handling, as byte array 756
 - handling, as file 756

- handling, as input stream 756
- handling, as stream of strings 757
- handling, as string 755
- response headers
 - obtaining 743
- response information
 - obtaining 754
- return type
 - annotations, inspecting 417

S

- Scanner
 - versus `BufferedReader` 378
 - working with 374, 375, 376, 377
- semaphore 624, 625, 626, 627
- serialization
 - objects, cloning via 109
- setters
 - fetching 407, 408, 409
 - generating 409, 411, 412, 413
- shortcuts
 - used, for creating file paths 302, 303
- sorting algorithms
 - about 204
 - bubble sort algorithm 204, 205, 206
 - counting sort algorithm 209, 210
 - heap sort algorithm 210, 211, 213, 214
 - insertion sort algorithm 206, 207, 208
- `Splitter` 551, 552
- `StampedLock` 693, 694, 695, 696, 697
- start of day
 - searching 159, 160, 161
- statement blocks 116
- static block 241
- static methods
 - obtaining 422, 424
- Strategy design pattern 442
- Strategy pattern
 - implementing 452, 453, 454
- Stream APIs
 - chaining 730, 731
- stream
 - creating, from array 227, 228
 - elements, matching 503, 504
 - `max()` 505

- `min()` 505
- non-zero elements, filtering of 482, 483, 484
- parallel processing 547, 548, 549, 550
- result, collecting 509, 510, 511, 512
- result, joining 513, 514
- `sum()` 505
- string constant pool (SCP) 92
- string immutability
 - about 91, 92
 - cons 95
 - pros 92, 93, 94
- string interning 92
- string
 - anagrams, checking 40, 41
 - array, sorting by length 36, 37
 - certain character, occurrences counting 21, 22
 - character, removing 32, 33
 - character, searching with most appearances 33, 34, 35
 - checking, that contains substring 37, 38
 - concatenating 43, 44
 - consonants, counting 19, 20, 21
 - converting, into double 23
 - converting, into float 23
 - converting, into int 23
 - converting, into long 23
 - converting, to date and time 120
 - digits, checking 18, 19
 - duplicate characters, counting 11, 12
 - duplicate characters, removing 30, 31
 - first non-repeatable character, searching 17
 - first non-repeated character, searching 14, 15, 16
 - indentation, applying 47, 48
 - issues 8, 9, 10, 11
 - joining, with delimiter 24, 25
 - leading spaces, removing 45
 - letters, reversing 17, 18
 - longest common prefix, searching 45, 46
 - palindrome, checking 28, 30
 - permutations, generating 26, 27, 28
 - solutions 11
 - substring, occurrences counting 38, 39
 - trailing spaces, removing 45

- transforming 49, 50
- using, as unsigned arithmetic in radix 52
- vowels, counting 19, 20, 21
- white spaces, removing 24
- words, reversing 17, 18
- subject 456
- subrange
 - checking, in range from 0 to length 83, 84
- substring
 - occurrences, counting in string 38, 39
- sum()
 - computing, via RecursiveTask 641, 643
 - in stream 504
 - terminal operations 505
- summarization collectors
 - about 514
 - averaging 516
 - counting 517
 - maximum 517
 - minimum 517
 - summing 514, 515, 516
- superclass
 - annotations, inspecting 419
 - generic, obtaining 426
- supplier() method 541
- surrogate pair 13
- switch expressions 112, 113, 114
- synchronizations
 - cases 575, 576
- synthetic constructs
 - using 399, 400

T

- takeWhile() 484, 485
- takeWhile(Predicate) methods
 - using 489, 490, 491
- task cancellation technique
 - using 675, 676
- teeing 535, 537, 538
- Template Method pattern
 - implementing 454, 455, 456
- Temporal
 - converting, to Date object 151
- temporary files/folders
 - creating 348, 349

- deleting, via DELETE_ON_CLOSE 351
- deleting, via deleteOnExit() 350
- deleting, via shutdown-hook 349
- working with 347, 348
- text files
 - reading, efficiently 326, 327, 328, 330
 - reading, in memory 331
 - writing 332, 333
 - writing, efficiently 326, 327, 328, 330
- thread pool, in Java
 - about 576
 - Executor 576
 - ExecutorService 577, 579
 - ScheduledExecutorService 579
 - via Executors 580
- thread pool, with single thread
 - about 581, 582
 - producer, not checking for consumer
 - availability 588, 589
 - producer, waiting for consumer availability
 - 582, 583, 584, 585, 586, 587
- thread pools
 - cached 591, 592, 593, 595, 596, 597, 598
 - scheduled 591, 592, 593, 595, 596, 597, 598
 - with fixed, number of threads 589, 590
- thread-safe collection 269
- thread-safe queue 269
- thread-safe stack 269
- ThreadLocal
 - about 677
 - per-thread context 680, 681
 - per-thread instances 677, 678, 679
- thrown exceptions
 - annotations, inspecting 417
- time zones
 - local date-time, obtaining in 142
 - obtaining, by extraction of offset 140
 - obtaining, with GMT 140
 - obtaining, with Java date-time API 140, 141, 142
 - obtaining, with UTC 140
- time-based values
 - used, for defining duration of time 132
- time

- testing 543, 544
- timeout
 - setting 749
- toString()
 - overriding 110, 111, 112

Trie

- about 46, 277
- basic structure 279
- building 282
- deleting 281, 282
- finding 280
- inserting 279
- node 278

tuple

- about 282, 283, 284
- method 283

type inference

- issues 170, 171
- solutions 172

U

- Unicode characters 12, 13, 14

- Uniform Resource Identifier (URI) 300

Union Find algorithm

- about 284, 285, 286
- find operation, implementing 287
- union operation, implementing 287, 288

union operation

- implementing 287, 288

Unix timestamp

- converting, to date-time 145, 146

unlimited streams

- creating, of pseudorandom values 487, 488

unmodifiable collections

- Arrays.asList() method 240
- Collections.unmodifiableList() method 239, 240, 241, 242, 243, 244
- creating 238, 239
- List.of() method 241, 242, 243, 244
- static block 241

unsigned conversion

- signed int, converting into long 53

unsigned numbers

- comparing 54

unsigned values

- division 55

- modulo 55

UTC

- about 140

- used, for obtaining time zones 140

V

var

- array, assigning 183

vowels

- counting 19, 20, 21

W

walking paths

- about 309

- file, searching by name 312, 313, 314

- Files.walk() 318

- folder, copying 315, 316, 317

- folder, deleting 314

- JDK 8 318

- trivial traversal, of folder 310, 311

watching paths

- about 319, 320

- folder, modifying 320, 321, 322, 323

WebSocket API

- issues 735, 736

- solutions 737

- WebSocket protocol 771, 772, 773

wildcards

- replacing, with Local Variable Type Inference (LVTI) 197

words

- reversing 17, 18

work-stealing thread pool

- about 598, 599, 600

- large number, of small tasks 601, 602

- time-consuming tasks, small number 603, 604

Z

zone offsets

- extracting 149

- extracting, via java.time.ZoneId 150, 151

- extracting, via java.time.ZoneOffset 150, 151

- extracting, via TimeZone.getRawOffset() 150